



US 20030128225A1

(19) **United States**

(12) **Patent Application Publication**
Credelle et al.

(10) **Pub. No.: US 2003/0128225 A1**

(43) **Pub. Date: Jul. 10, 2003**

(54) **COLOR FLAT PANEL DISPLAY SUB-PIXEL ARRANGEMENTS AND LAYOUTS FOR SUB-PIXEL RENDERING WITH INCREASED MODULATION TRANSFER FUNCTION RESPONSE**

Related U.S. Application Data

(63) Continuation-in-part of application No. 10/243,094, filed on Sep. 13, 2002.

(60) Provisional application No. 60/346,738, filed on Jan. 7, 2002.

(76) Inventors: **Thomas Lloyd Credelle**, Morgan Hill, CA (US); **Candice Hellen Brown Elliott**, Vallejo, CA (US); **Michael Francis Higgins**, Cazadaro, CA (US)

Publication Classification

(51) **Int. Cl.⁷ G09G 5/02**

(52) **U.S. Cl. 345/694**

Correspondence Address:
Finnegan, Henderson, Farabow, Garrett & Dunner, L.L.P.
1300 I Street, N.W.
Washington, DC 20005-3315 (US)

(57) **ABSTRACT**

Various embodiments of a sub-pixel octal grouping are disclosed. The octal grouping may comprise three-color sub-pixels with one colored sub-pixel comprising twice the number of positions within the octal sub-pixel grouping as the other two colored sub-pixels. Various embodiments for performing sub-pixel rendering on the sub-pixel groupings are disclosed.

(21) Appl. No.: **10/278,353**

(22) Filed: **Oct. 22, 2002**

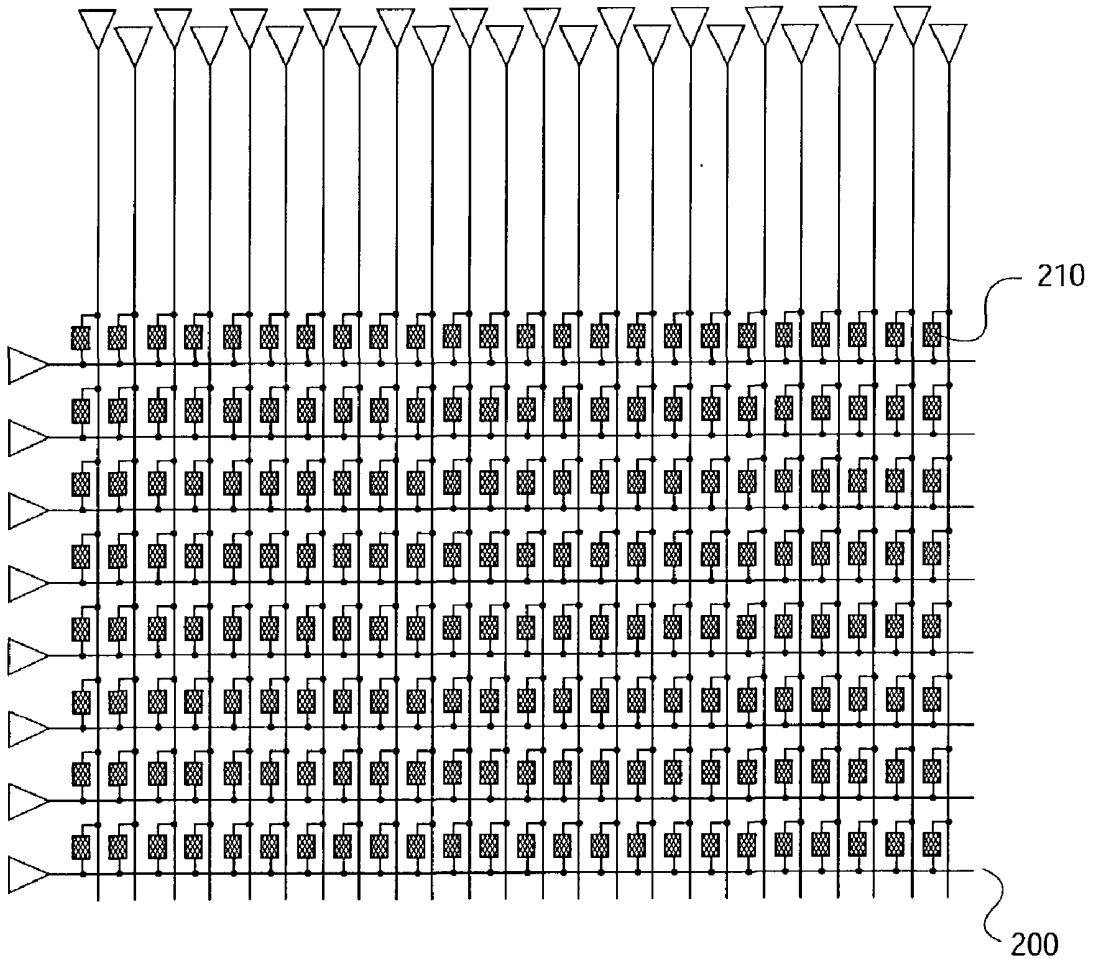

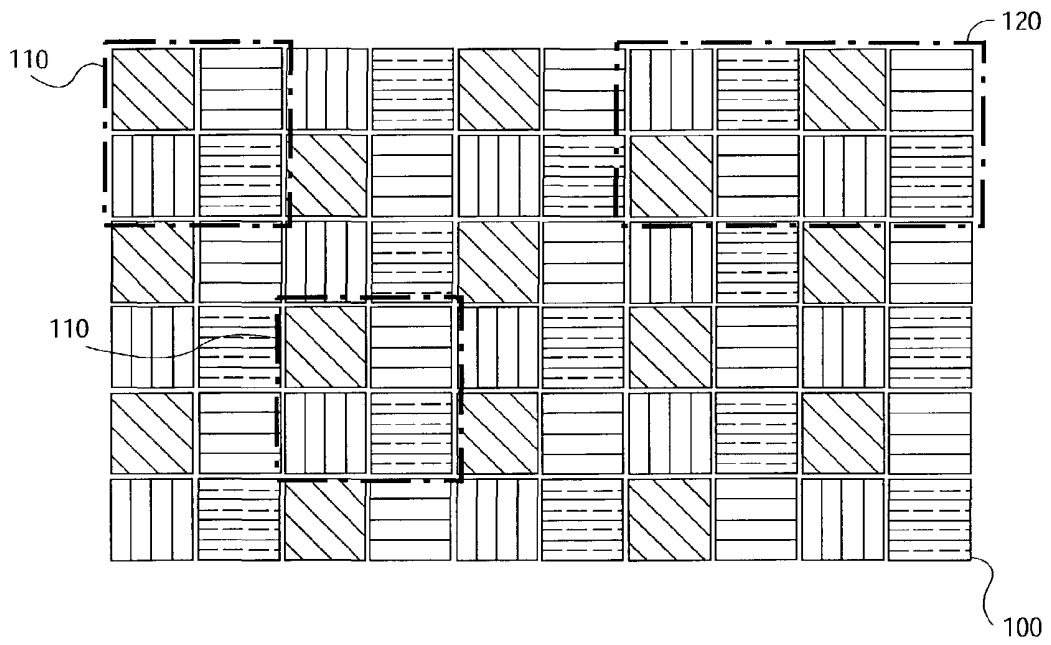

FIG. 1A

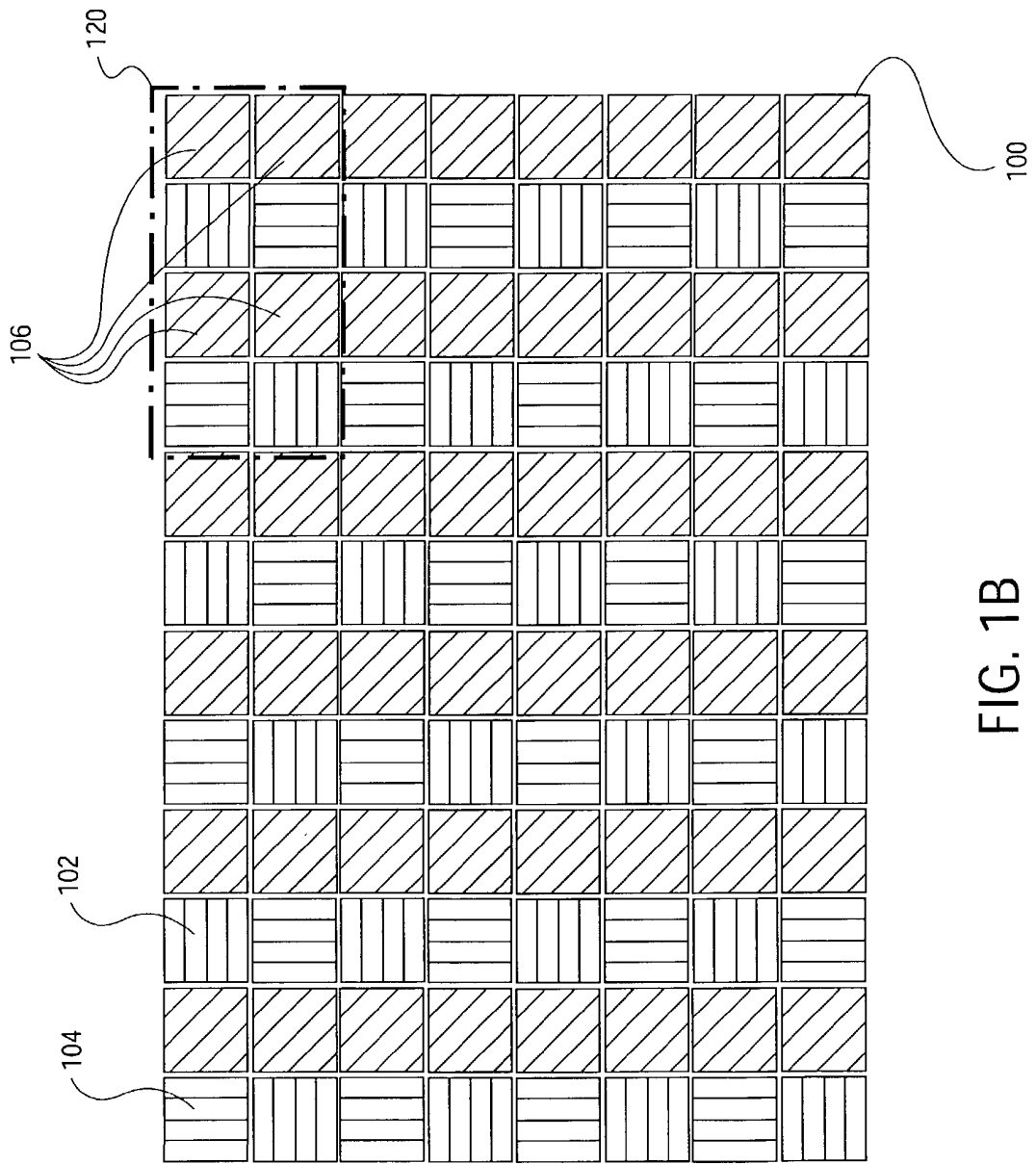

FIG. 1B

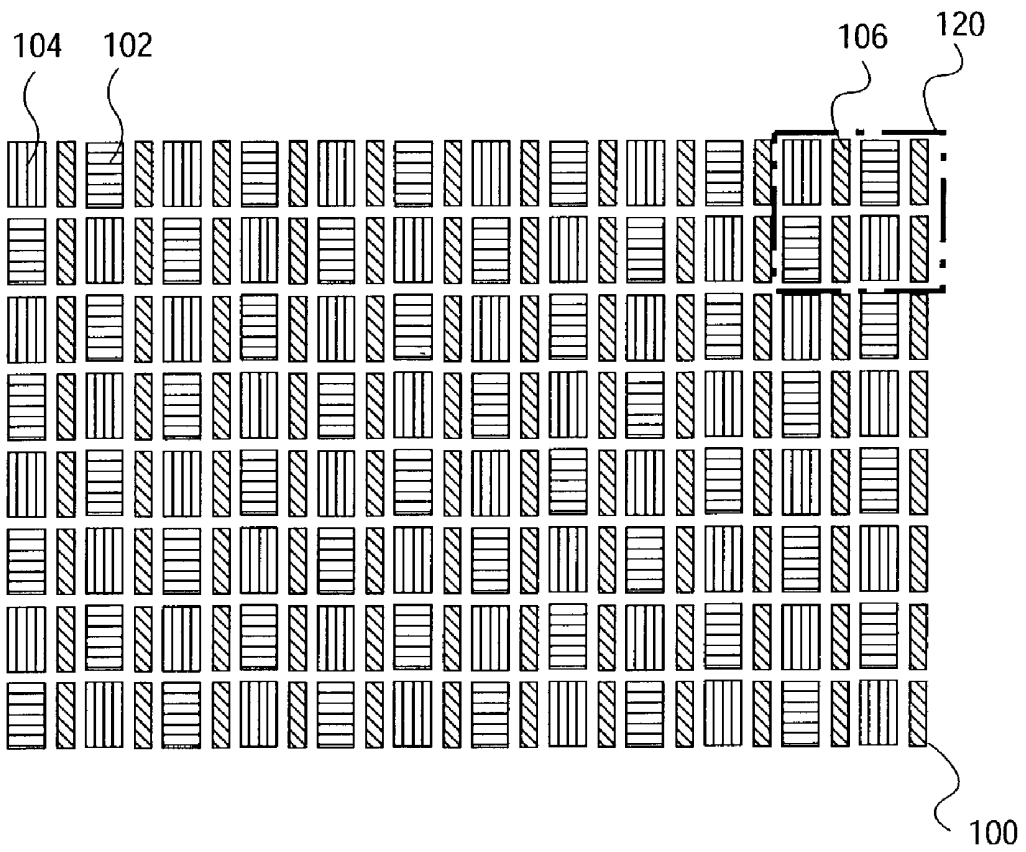

FIG. 1C

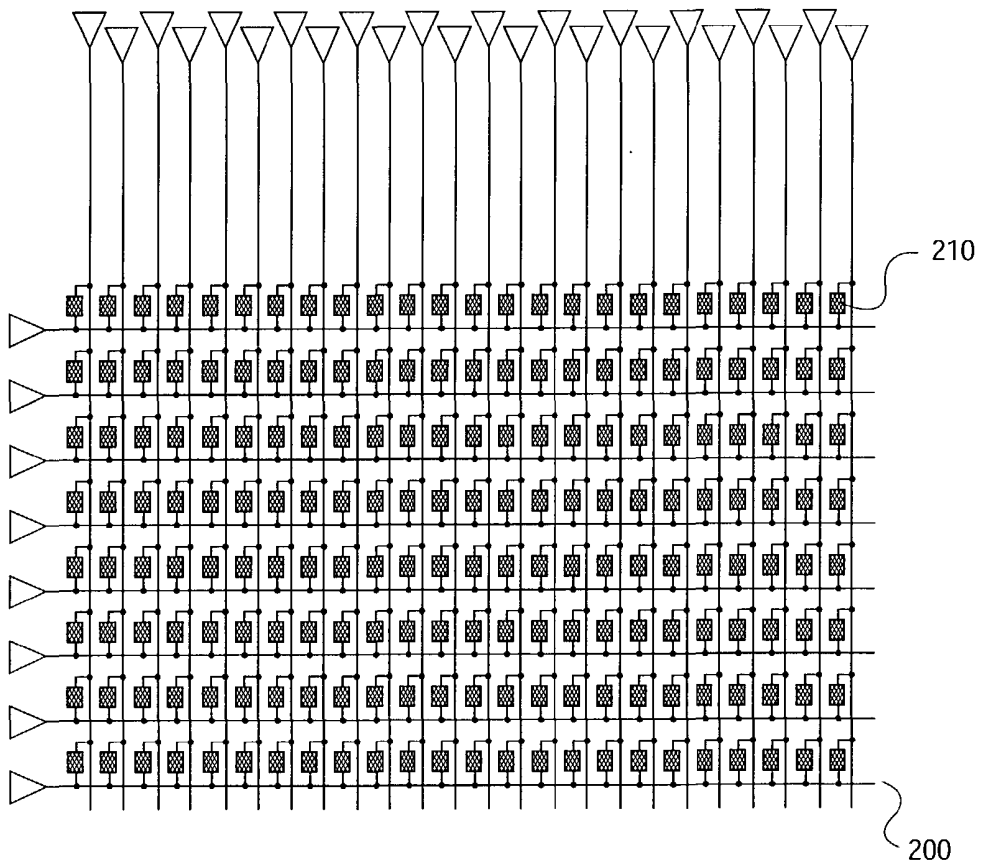

FIG. 2

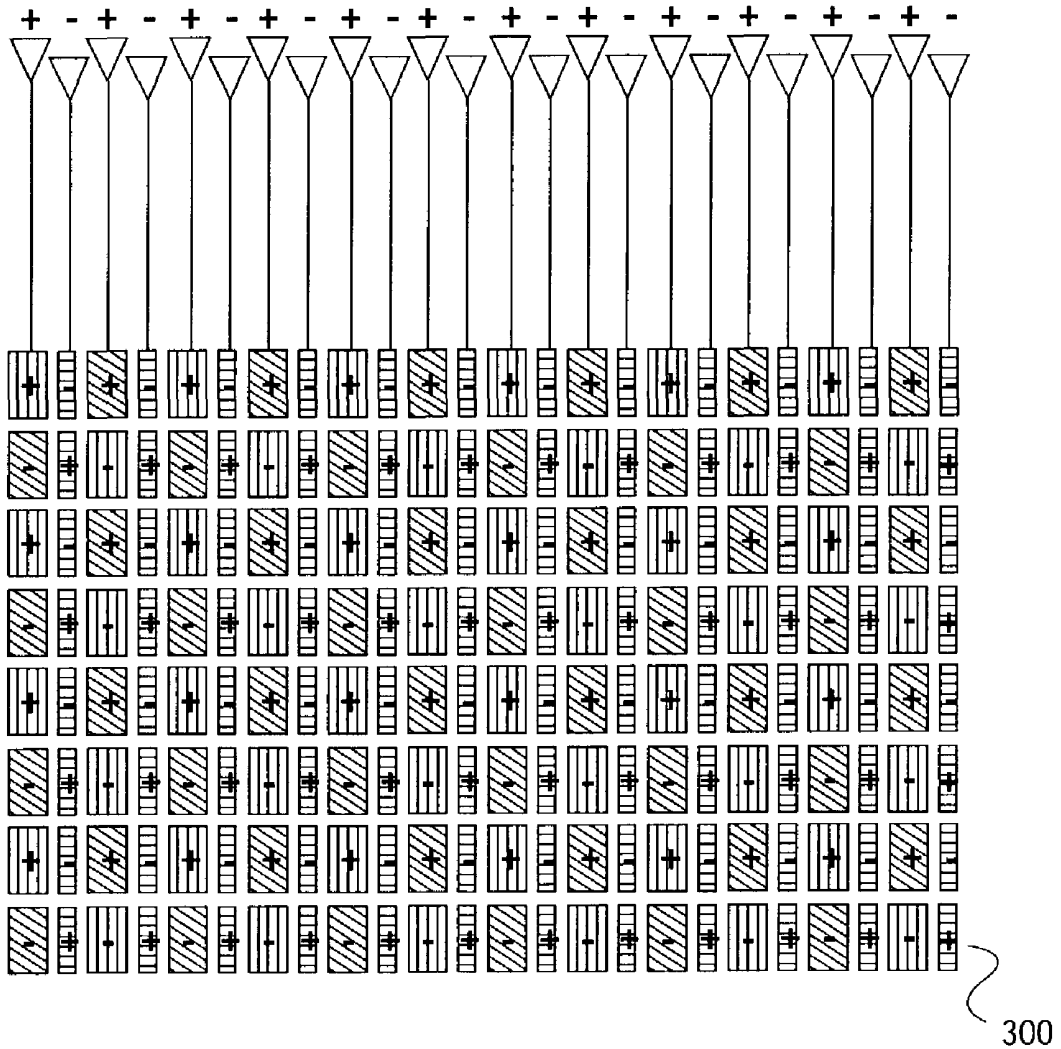

FIG. 3A

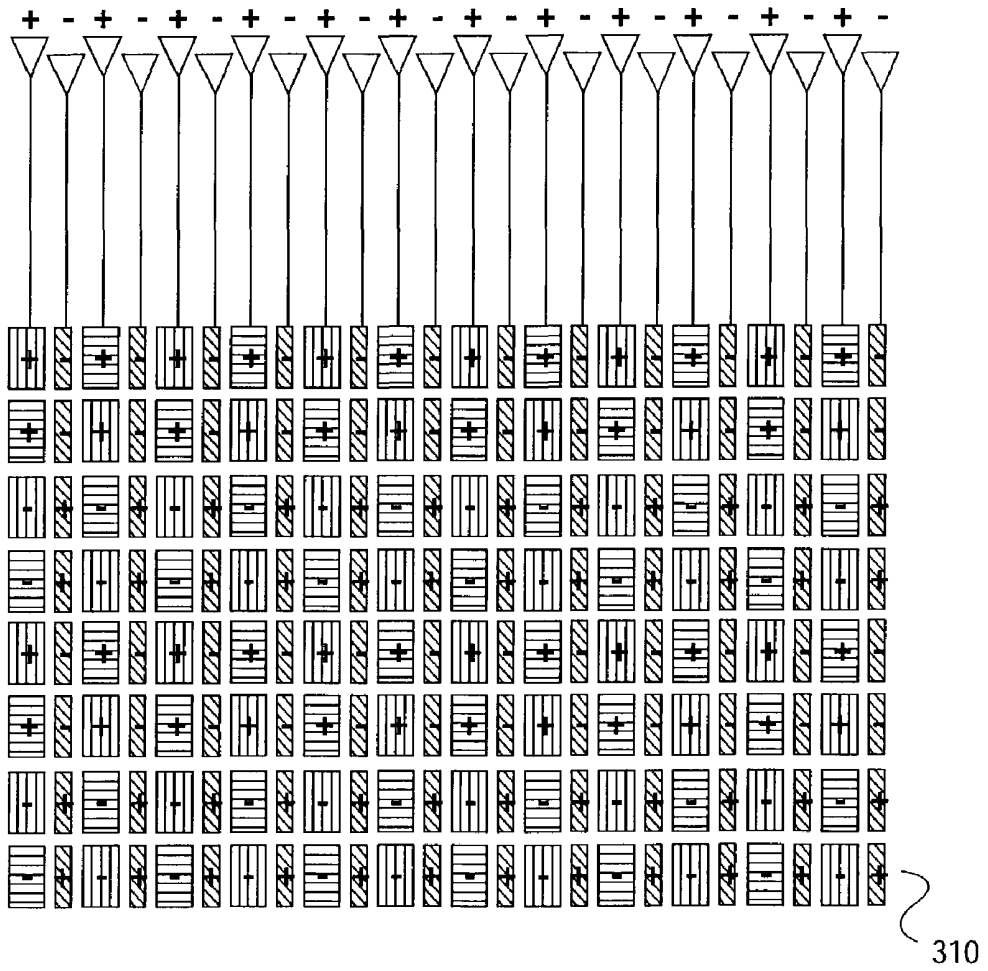

FIG. 3B

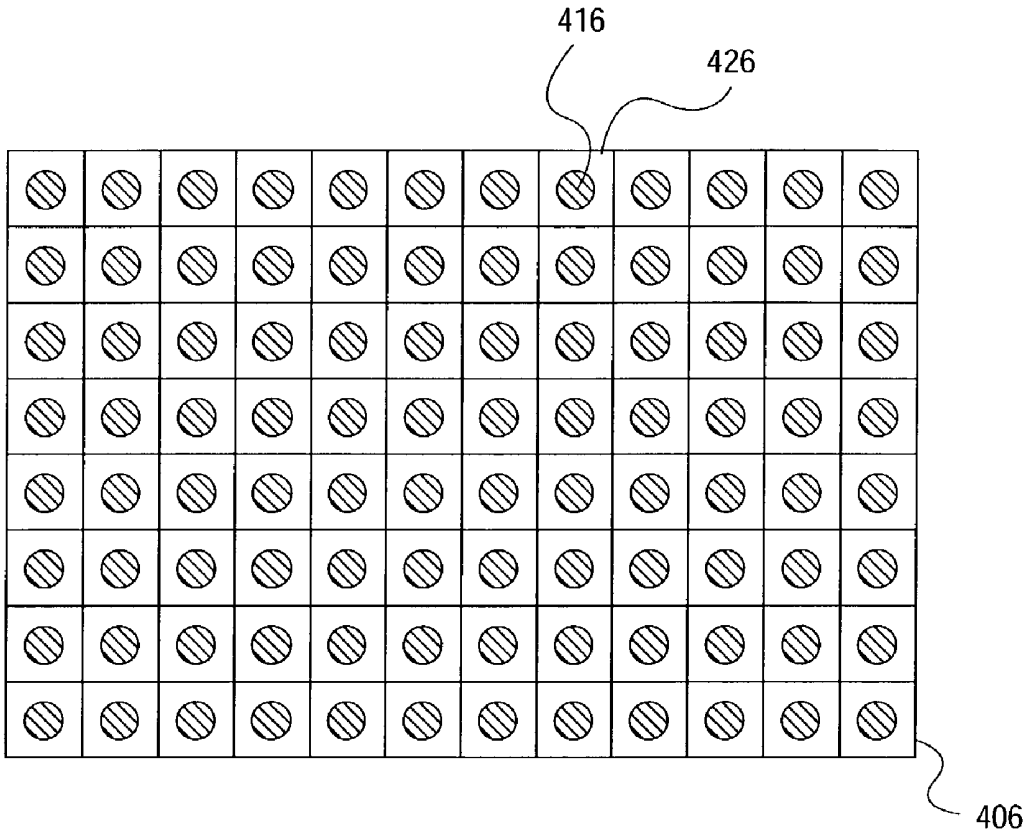

FIG. 4A

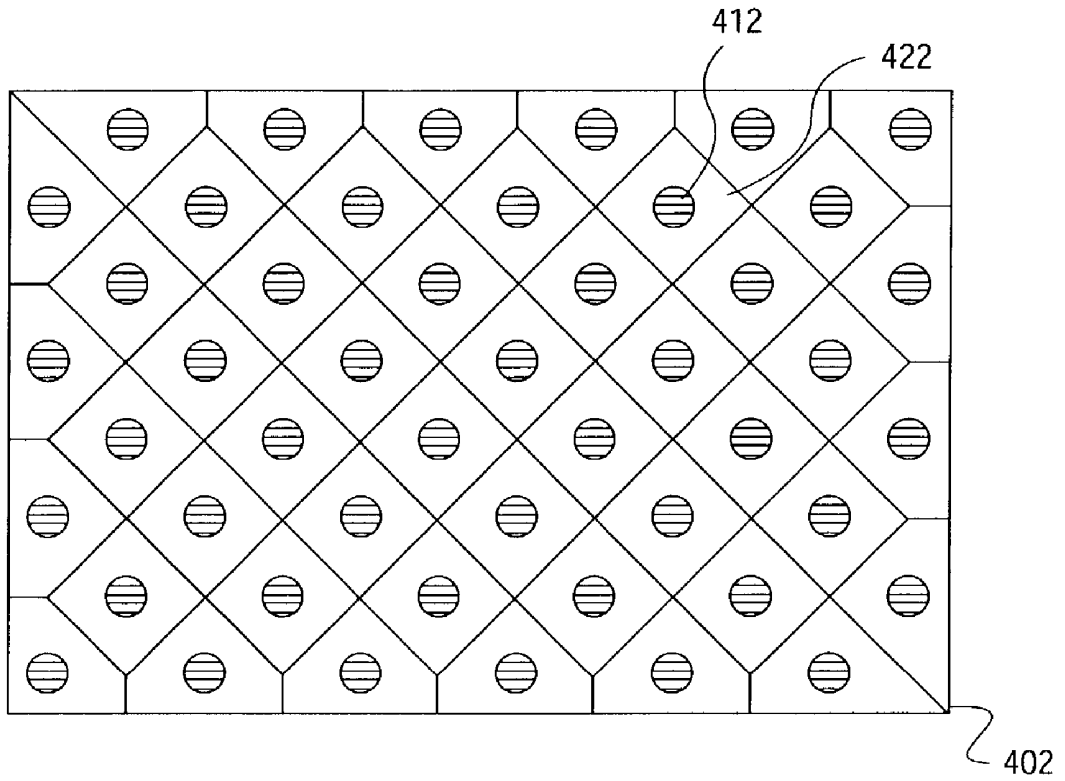

FIG. 4B

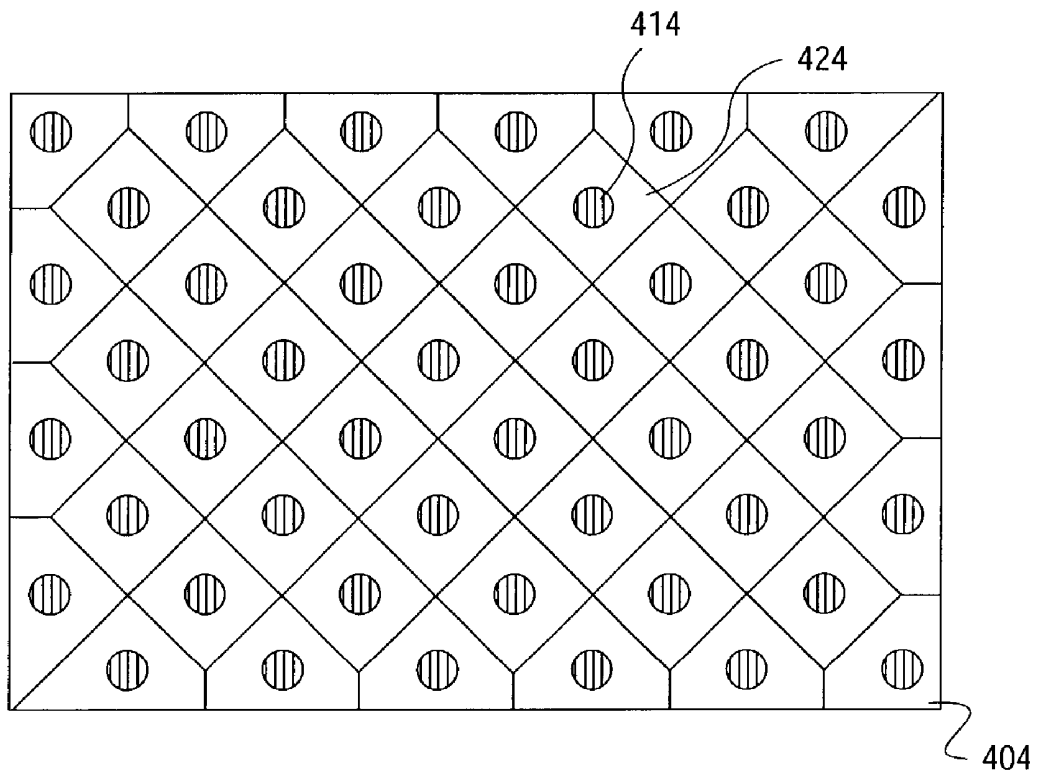

FIG. 4C

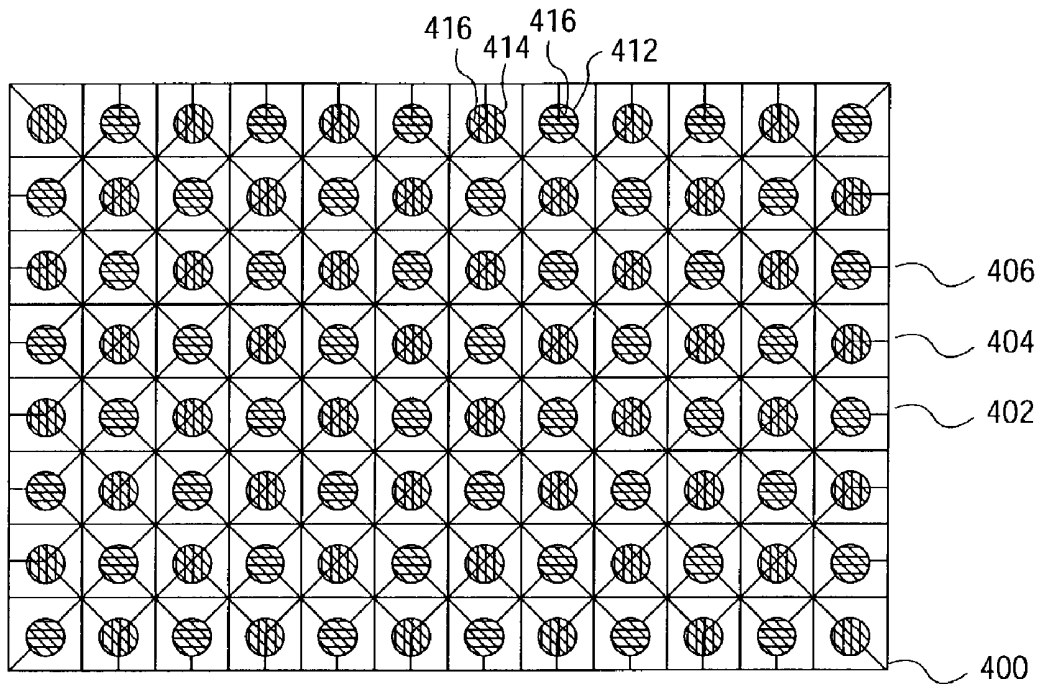

FIG. 4D

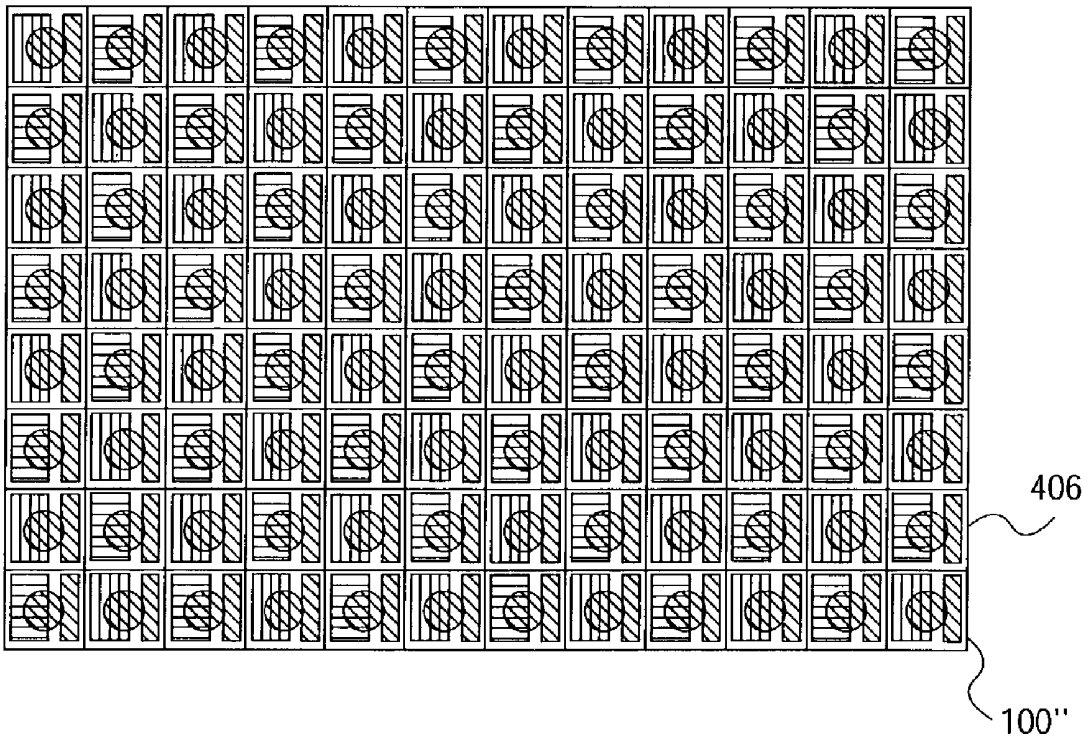

FIG. 5A

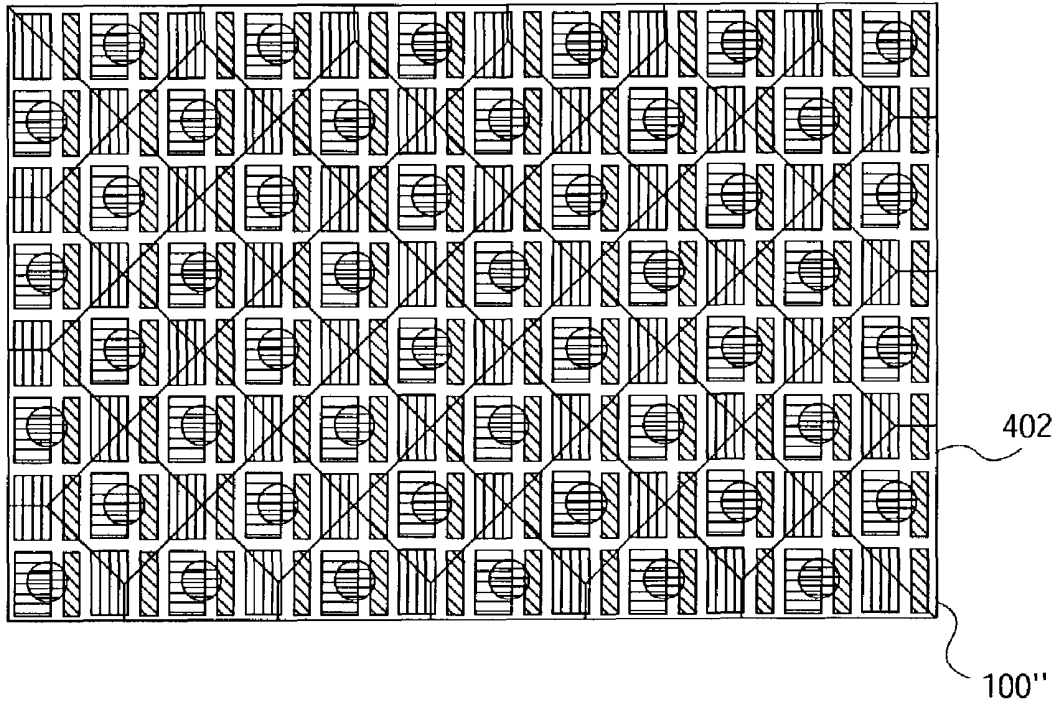

FIG. 5B

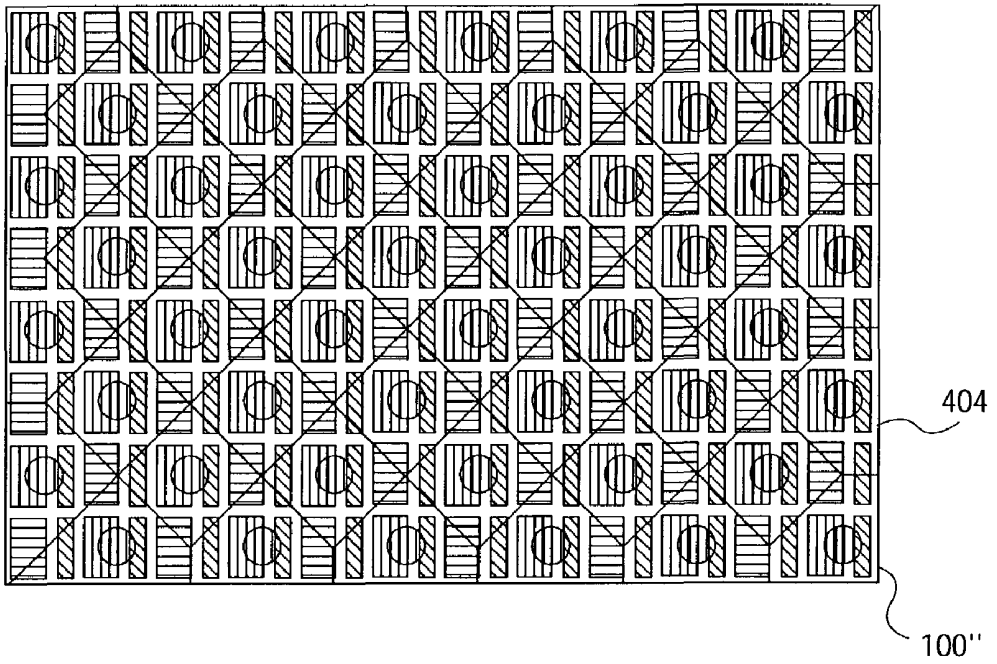

FIG. 5C

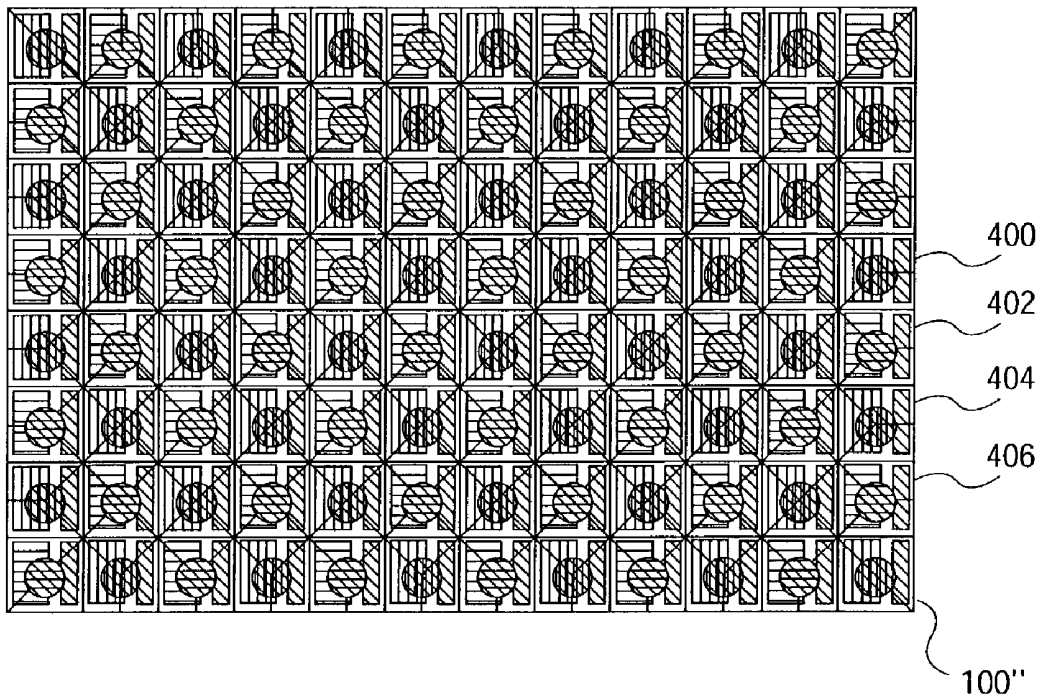

FIG. 5D

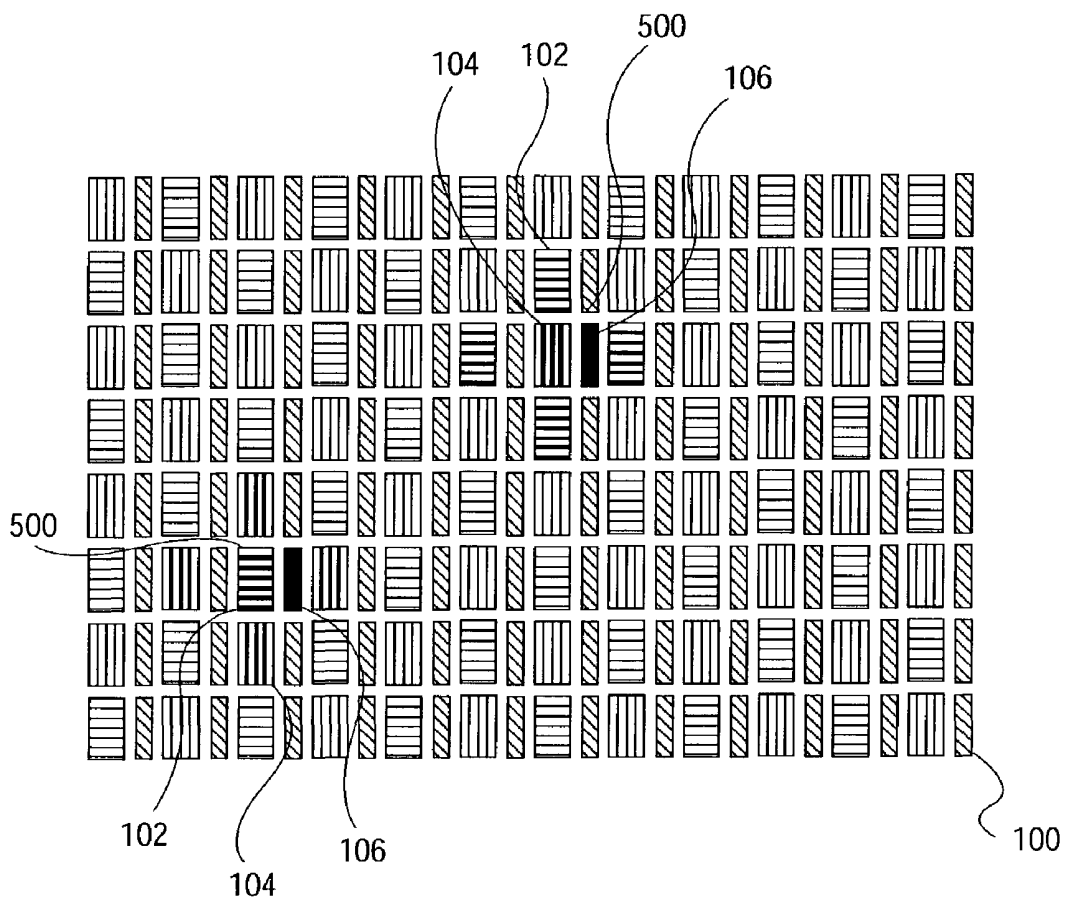

FIG. 5E

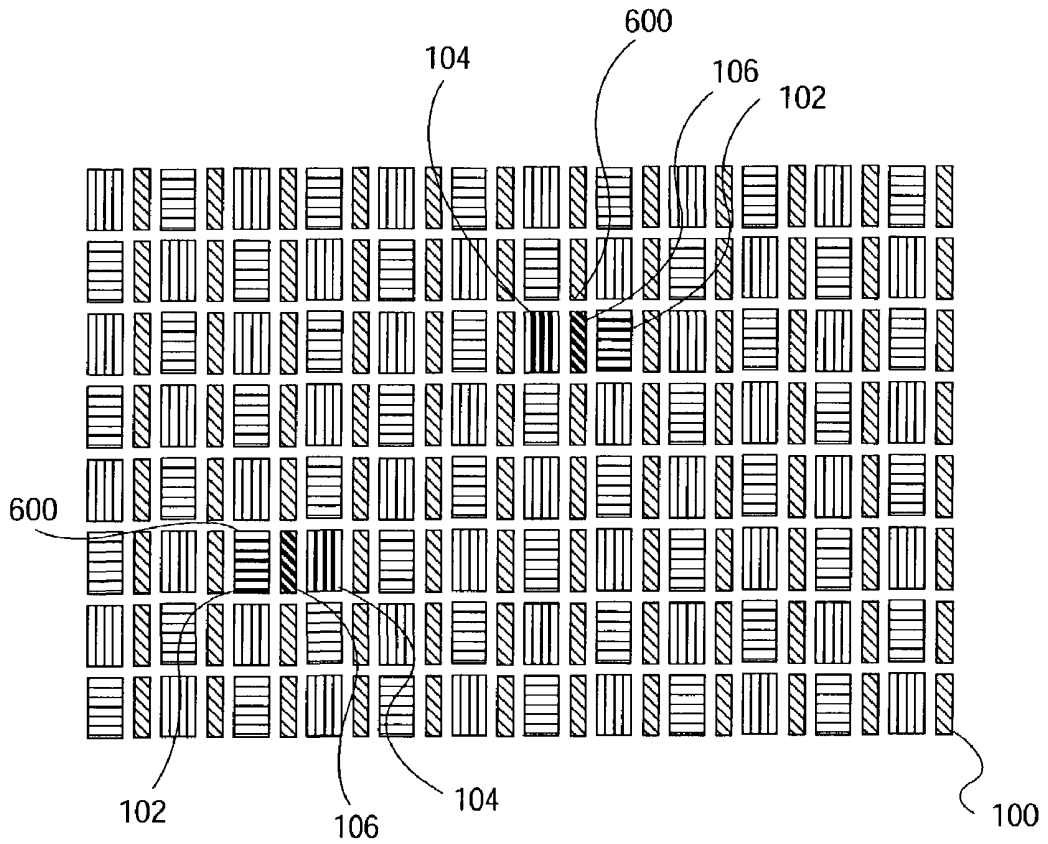

FIG. 6A

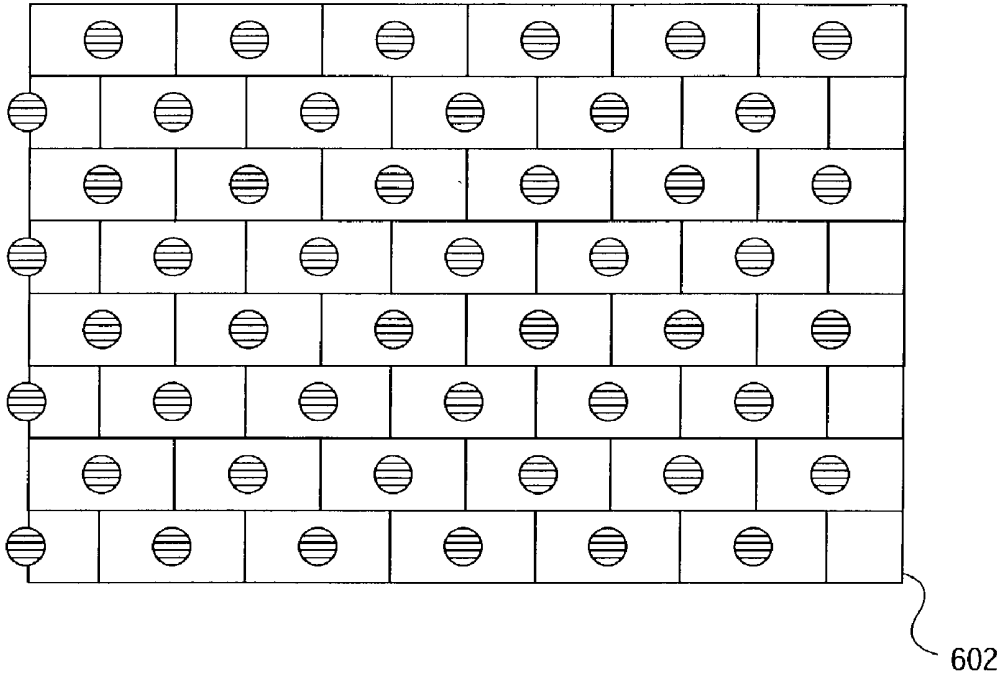

FIG. 6B

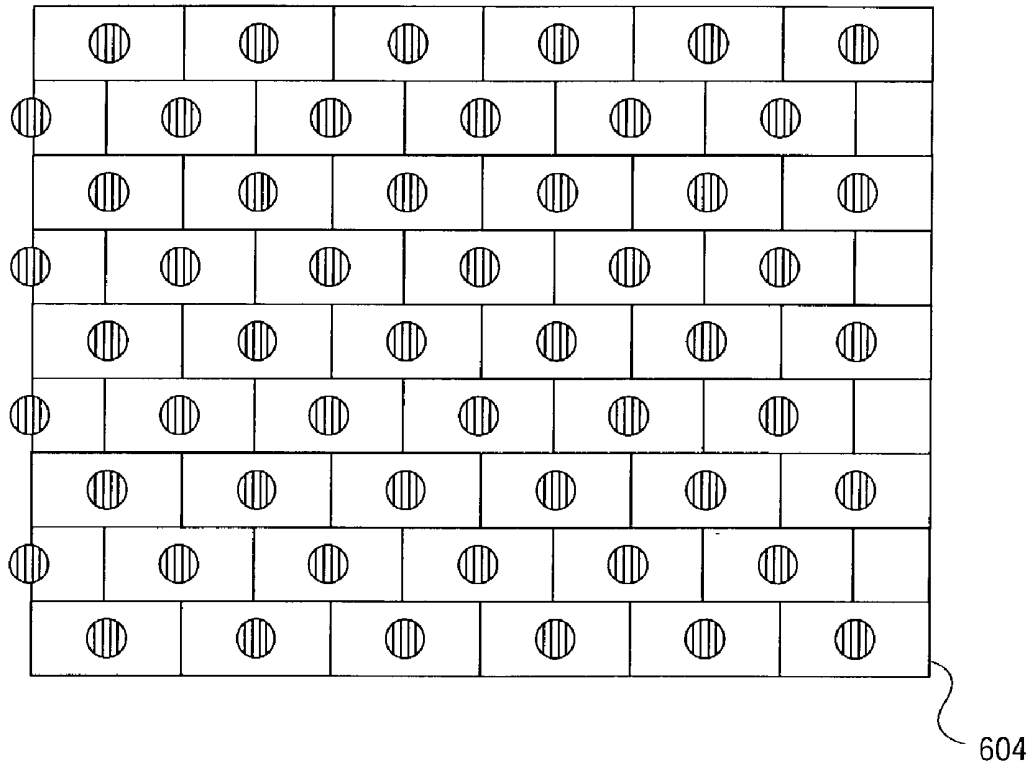

FIG. 6C

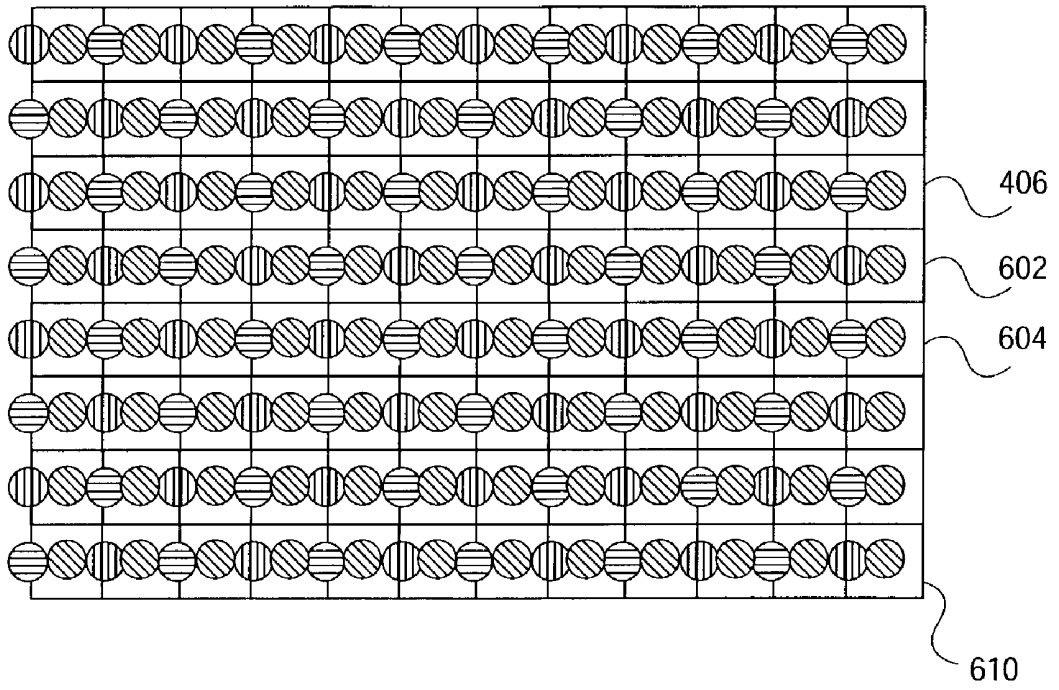

FIG. 6D

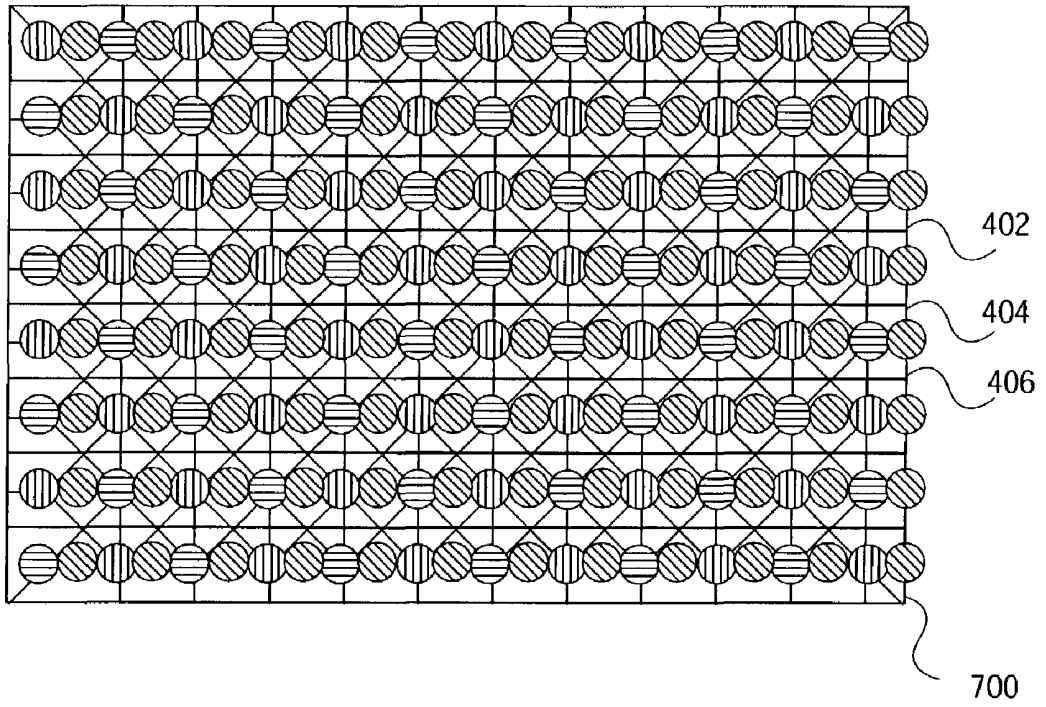

FIG. 7A

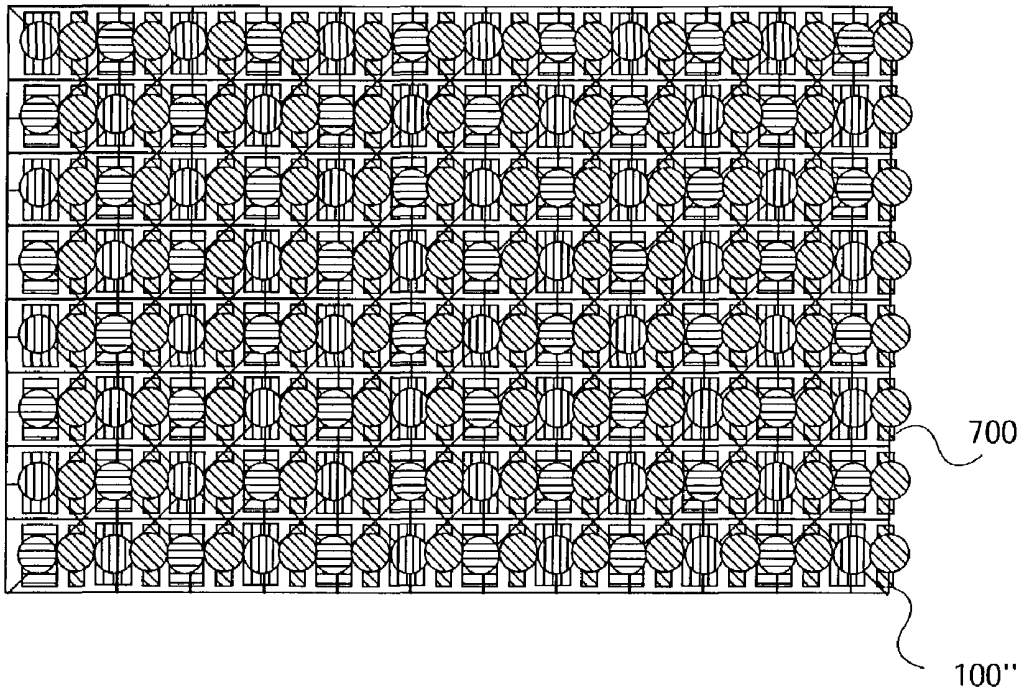

FIG. 7B

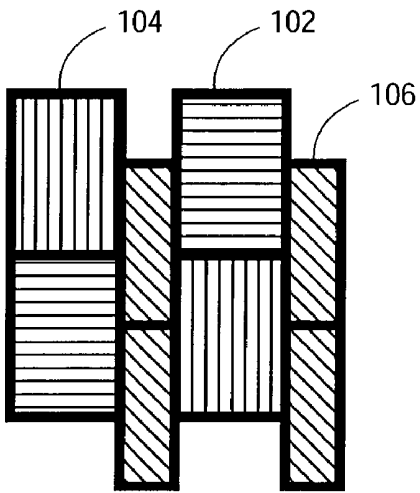

FIG. 8A

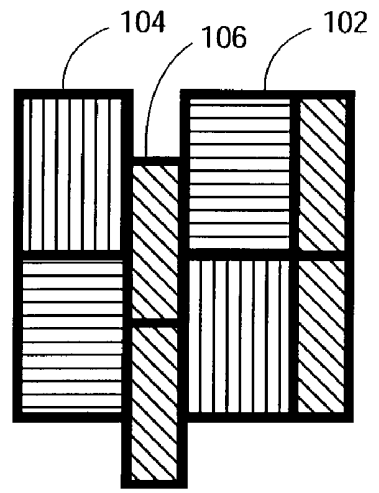

FIG. 8B

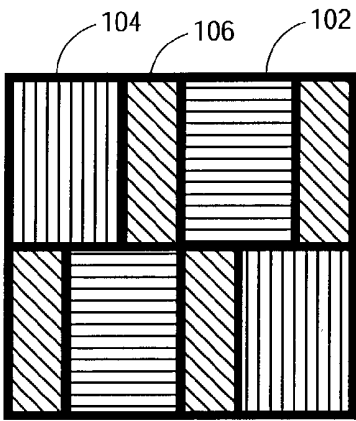

FIG. 9A

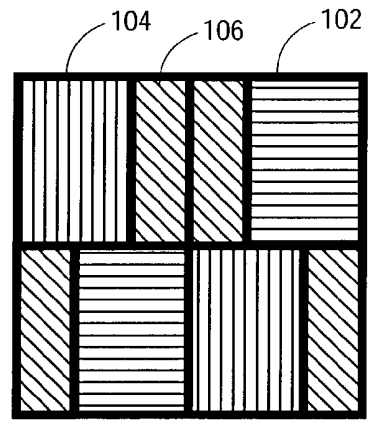

FIG. 9B

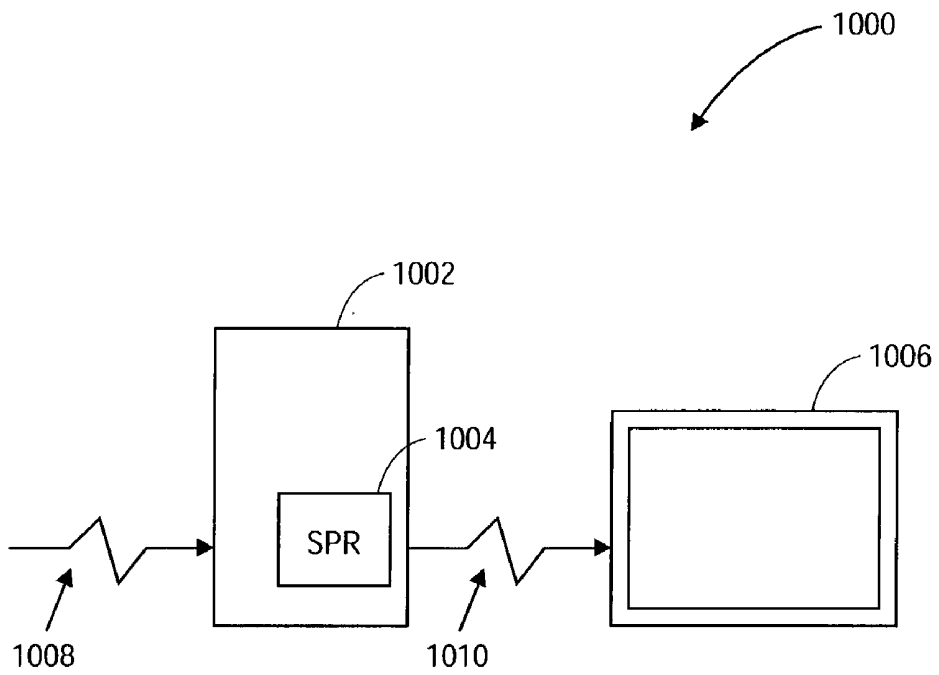

FIG. 10



FIG. 11A

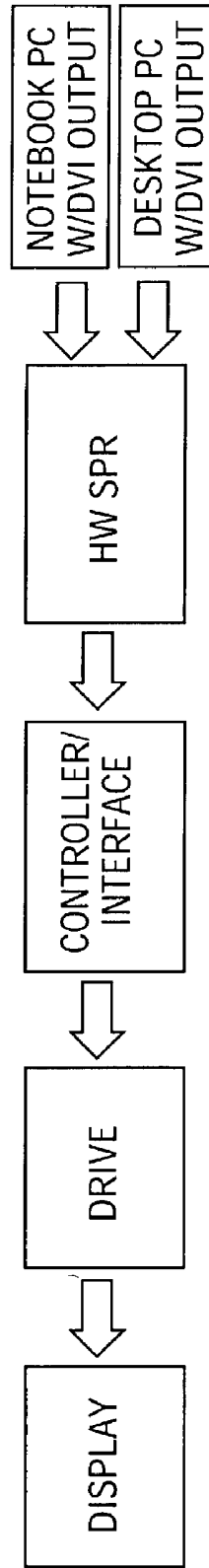

FIG. 11B

**COLOR FLAT PANEL DISPLAY SUB-PIXEL
ARRANGEMENTS AND LAYOUTS FOR
SUB-PIXEL RENDERING WITH INCREASED
MODULATION TRANSFER FUNCTION
RESPONSE**

RELATED APPLICATIONS

[0001] This application claims priority to U.S. Provisional Application No. 60/346,738 (“the ’738 provisional application”), entitled “ARRANGEMENT OF SUB-PIXELS WITH DOUBLE BLUE STRIPES,” filed on Jan. 7, 2002, which is hereby incorporated herein by reference. This application is also a continuation-in-part of U.S. patent application Ser. No. 10/243,094 (“the ’094 application”), entitled “IMPROVED FOUR COLOR ARRANGEMENTS OF EMITTERS FOR SUB-PIXEL RENDERING,” filed on Sep. 13, 2002, which is hereby incorporated herein by reference and is commonly owned by the same assignee of this application.

[0002] This application is also related to U.S. patent application Ser. No. _____, entitled “IMPROVEMENTS TO COLOR FLAT PANEL DISPLAY SUB-PIXEL ARRANGEMENTS AND LAYOUTS WITH REDUCED BLUE LUMINANCE WELL VISIBILITY,” filed on _____; U.S. patent application Ser. No. _____, entitled “COLOR DISPLAY HAVING HORIZONTAL SUB-PIXEL ARRANGEMENTS AND LAYOUTS,” filed on _____; and U.S. patent application Ser. No. _____, entitled “IMPROVEMENTS TO COLOR FLAT PANEL DISPLAY SUB-PIXEL ARRANGEMENTS AND LAYOUTS FOR SUB-PIXEL RENDERING WITH SPLIT BLUE SUBPIXELS,” filed on _____, which are all hereby incorporated herein by reference and commonly owned by the same assignee of this application.

BACKGROUND

[0003] The present application relates to improvements to display layouts, and, more particularly, to improved color pixel arrangements, means of addressing used in displays, and to data format conversion methods for these displays.

[0004] Full color perception is produced in the eye by three-color receptor nerve cell types called cones. The three types are sensitive to different wavelengths of light: long, medium, and short (“red”, “green”, and “blue”, respectively). The relative density of the three differs significantly from one another. There are slightly more red receptors than green receptors. There are very few blue receptors compared to red or green receptors.

[0005] The human vision system processes the information detected by the eye in several perceptual channels: luminance, chrominance, and motion. Motion is only important for flicker threshold to the imaging system designer. The luminance channel takes the input from only the red and green receptors. In other words, the luminance channel is “color blind”. It processes the information in such a manner that the contrast of edges is enhanced. The chrominance channel does not have edge contrast enhancement. Since the luminance channel uses and enhances every red and green receptor, the resolution of the luminance channel is several times higher than the chrominance channels. Consequently, the blue receptor contribution to luminance perception is negligible. The luminance channel thus acts as a spatial frequency signal band pass filter. Its peak

response is at 35 cycles per degree (cycles/°). It limits the response at 0 cycles/° and at 50 cycles/° in the horizontal and vertical axis. This means that the luminance channel can only tell the relative brightness between two areas within the field of view. It cannot tell the absolute brightness. Further, if any detail is finer than 50 cycles/°, it simply blends together. The limit in the horizontal axis is slightly higher than the vertical axis. The limit in the diagonal axes is somewhat lower.

[0006] The chrominance channel is further subdivided into two sub-channels, to allow us to see full color. These channels are quite different from the luminance channel, acting as low pass filters. One can always tell what color an object is, no matter how big it is in our field of view. The red/green chrominance sub-channel resolution limit is at 8 cycles/°, while the yellow/blue chrominance sub-channel resolution limit is at 4 cycles/°. Thus, the error introduced by lowering the red/green resolution or the yellow/blue resolution by one octave will be barely noticeable by the most perceptive viewer, if at all, as experiments at Xerox and NASA, Ames Research Center (see, e.g., R. Martin, J. Gille, J. Larimer, Detectability of Reduced Blue Pixel Count in Projection Displays, SID Digest 1993) have demonstrated.

[0007] The luminance channel determines image details by analyzing the spatial frequency Fourier transform components. From signal theory, any given signal can be represented as the summation of a series of sine waves of varying amplitude and frequency. The process of teasing out, mathematically, these sine-wave-components of a given signal is called a Fourier Transform. The human vision system responds to these sine-wave-components in the two-dimensional image signal.

[0008] Color perception is influenced by a process called “assimilation” or the Von Bezold color blending effect. This is what allows separate color pixels (also known as sub-pixels or emitters) of a display to be perceived as a mixed color. This blending effect happens over a given angular distance in the field of view. Because of the relatively scarce blue receptors, this blending happens over a greater angle for blue than for red or green. This distance is approximately 0.25° for blue, while for red or green it is approximately 0.12°. At a viewing distance of twelve inches, 0.25° subtends 50 mils (1,270 μ) on a display. Thus, if the blue pixel pitch is less than half (625 μ) of this blending pitch, the colors will blend without loss of picture quality. This blending effect is directly related to the chrominance sub-channel resolution limits described above. Below the resolution limit, one sees separate colors, above the resolution limit, one sees the combined color.

BRIEF DESCRIPTION OF THE DRAWINGS

[0009] The accompanying drawings, which are incorporated in, and constitute a part of this specification illustrate various implementations and embodiments disclosed herein.

[0010] **FIG. 1A** shows an arrangement of four-color pixel elements in an array, in a single plane, for a display device, having a repeat cell consisting of eight sub-pixels.

[0011] **FIG. 1B** shows an arrangement of three-color pixel elements in an array, in a single plane, for a display device, having a repeat cell of consisting of eight sub-pixels generated by selecting and defining four of the eight sub-pixels of **FIG. 1A** as the same color.

[0012] FIG. 1C shows an arrangement of three-color pixel elements in an array, in a single plane, for a display device, having a repeat cell of consisting of eight sub-pixels generated by selecting and defining four of the eight sub-pixels of FIG. 1A as the same color and reducing their widths.

[0013] FIG. 2 shows a schematic of an electronic drive arrangement for the arrangement of sub-pixels shown in FIGS. 1A, 1B, and 1C.

[0014] FIGS. 3A and 3B illustrate the relative polarities of active matrix dot inversion drive methods for a Liquid Crystal Display using the arrangement of color sub-pixels of FIG. 1C and the drive arrangement of FIG. 2.

[0015] FIGS. 4A, 4B, 4C, and 4D illustrate a set of green, blue, and red resample areas separately and overlaid, respectively, for the arrangement of sub-pixels of FIG. 1C.

[0016] FIGS. 5A, 5B, 5C, and 5D illustrate the set of green, blue, and red resample areas of FIGS. 4A, 4B, 4C, and 4D respectively, overlaid on the arrangement of sub-pixels of FIG. 1C to show their relative positions.

[0017] FIG. 5E illustrates two logical pixels displayed on the arrangement of FIG. 1C, resulting from the sub-pixel rendering operation of the resample areas of FIG. 4D.

[0018] FIG. 6A illustrates two logical pixels displayed on the arrangement of FIG. 1C, resulting from the sub-pixel rendering operation of the resample areas of FIG. 6D.

[0019] FIGS. 6B, 6C, and 6D illustrate a set of blue and red resample areas separately, and overlaid along with the green resample areas illustrated in FIG. 4A on arrangement of sub-pixels of FIG. 1C, respectively.

[0020] FIG. 7A illustrates the set of green, blue, and red resample areas of FIGS. 4A, 4B, and 4C respectively, overlaid show their relative positions.

[0021] FIG. 7B illustrates the arrangement of resample areas of FIG. 7A overlaid on the arrangement of sub-pixels of FIG. 1C to show their relative positions.

[0022] FIGS. 8A and 8B show other embodiments of the octal subpixel arrangement with various vertical displacements of the subpixels.

[0023] FIGS. 9A and 9B show yet other embodiments of the octal subpixel arrangement of various displacements of the split majority subpixel within the subpixel grouping.

[0024] FIG. 10 depicts a system incorporating sub-pixel rendering techniques suitable to drive a panel made in accordance with the various embodiments described herein.

[0025] FIGS. 11A and 11B depict two particular embodiments of flowcharts to perform software and hardware sub-pixel rendering on a suitable display.

[0026] FIG. 12 is one particular embodiment of an implementation of a display made in accordance with several embodiments herein disclosed.

DETAILED DESCRIPTION

[0027] Reference will now be made in detail to implementations and embodiments of the invention, examples of which are illustrated in the accompanying drawings. Wherever possible, the same reference numbers will be used throughout the drawings to refer to the same or like parts.

[0028] Sub-Pixel Arrangements

[0029] FIG. 1A shows an arrangement of sub-pixel emitters 100 having four color emitters in groupings 110 that is shifted down every other column group by one sub-pixel. This creates a larger rectilinearly repeating cell group 120 of eight sub-pixels. This layout was introduced in the '094 application. Also disclosed in the '094 application is the practice of setting a plurality of the sub-pixels within the repeat cell to the same color point, an example of which is illustrated in FIG. 1B, wherein four of the emitters 106 in the eight emitter repeat cell group 120 are set to the same color. For example, these four emitters 106 may be set to be luminance adjusted (i.e. balanced) green in color. For example, the other sub-pixel emitters may be set to be red 104 and blue 102. The luminance balanced green 106 sub-pixels have twice the area, i.e., "real-estate," per color as the red 104 and blue 102 sub-pixels, but being balanced to have the same luminance as the red 104 sub-pixels, the total green energy is balanced to produce a pleasing white point when all sub-pixels are illuminated fully. The manner of balancing the luminance of the green color sub-pixel was previously disclosed in the '094 application.

[0030] In FIG. 1C, the four sub-pixel emitters 106 are reduced in size and aspect ratio compared to the other two sub-pixel emitters 104 and 102. The minority sub-pixels 104 and 102 may also be adjusted in aspect ratio. In this example, the relative size of sub-pixel 106 is adjusted to be one half of that of sub-pixels 104 or 102. As before, the colors may be assigned as desired. It should also be noted that although the repeat octal grouping is shown that the majority color sub-pixels occupy the second and fourth columns, it also suffices that the majority sub-pixels could occupy the first and the third columns as well.

[0031] In another embodiment, the colors are assigned as red 104, blue 102, and non-luminance balanced green 106. Since there are twice as many green 106 as there are of the other two colors, red 104 and blue 102, the result is a pleasing white point when all sub-pixels are illuminated fully.

[0032] In this or another color assignment embodiment, the sub-pixel aspect ratios may be adjusted so that the display array 100 consists of square repeat cell groups 120. This will put the majority color sub-pixel emitter 106 on a square grid. It will also put the minority color sub-pixel emitters 102 and 104 on, or nearly on, an idealized "checkerboard". For an example of another color assignment embodiments, sub-pixels 106 could be assigned the color red and sub-pixels 104 could be assigned the color green in FIGS. 1B and 1C. Under this color assignment, the algorithms for sub-pixel rendering discussed below would work similarly.

[0033] Not only may the green or the red sub-pixels occupy the majority colored sub-pixels in octal grouping 120; but the blue sub-pixels may also occupy the majority sub-pixels. Such an arrangement was previously disclosed in '738 provisional application. Thus, all three colors—red, green, and blue—may occupy the majority sub-pixel position in this grouping. Additionally, while the colors—red, green and blue—have been used for the purposes of illustrating the present embodiments, it should be appreciated that another suitable choice of three colors—representing a suitable color gamut for a display—may also suffice for the purposes of the present invention.

[0034] As shown in **FIGS. 1A, 1B** and **1C**, the subpixels appear to have a substantially rectangular appearance. It should be appreciated that other shapes to the subpixels are also possible and are contemplated within the scope of the present invention. For example, a multitude of other regular or irregular shapes for the subpixels are possible and are desirable if manufacturable. It suffices only that there is an octal grouping of colored subpixels in the fashion herein described that may be addressable for the purposes of subpixel rendering (SPR).

[0035] As subpixel shapes may vary under the scope of the present invention, so too may the exact positions of the subpixels be varied under the scope of the present invention. For example, **FIGS. 8A and 8B** depict a similar octal subpixel grouping wherein one or both of the majority stripes **106** are offset (relatively or otherwise) from the other subpixels **102** and **104**. Other vertical offsets are also possible.

[0036] Other embodiments of the octal groupings are also possible. **FIGS. 9A and 9B** depict octal groupings wherein the majority subpixels **106** are interspersed within the checkerboard of subpixels **102** and **104**. Other arrangements of majority subpixel placement within such a checkerboard are also possible and are contemplated within the scope of the present invention.

[0037] **FIGS. 9A and 9B** may have column electrodes that zig-zag across the display. Column driver savings should be one third when compared to the RGB stripe system with the same resolution and the number of subpixels are about two thirds of the number of subpixels when compared to the RGB stripe system.

[0038] Yet other embodiments of the present invention are possible. For example, the entire octal subpixel groupings may be rotated **90** degrees to reverse the roles of row and column driver connections to the grouping. Such a horizontal arrangement for subpixels is further disclosed in the co-pending application entitled "COLOR DISPLAY HAVING HORIZONTAL SUB-PIXEL ARRANGEMENTS AND LAYOUTS" and is incorporated by reference.

[0039] The alternating "checkerboard" of emitters is similar to the red and green "checkerboard" that was disclosed in co-pending and commonly assigned U.S. patent application Ser. No. 09/916,232 ("the '232 application"), entitled "ARRANGEMENT OF COLOR PIXELS FOR FULL COLOR IMAGING DEVICES WITH SIMPLIFIED ADDRESSING," filed on Jul. 25, 2001, using sub-pixel rendering such as that described in copending U.S. patent application Ser. No. 10/150,355 ("the '355 application"), entitled "METHODS AND SYSTEMS FOR SUB-PIXEL RENDERING WITH GAMMA ADJUSTMENT," filed on May 17, 2002. These co-pending applications are hereby incorporated herein by reference. The methods described in the above co-pending applications may be modified for the embodiments disclosed herein.

[0040] **FIG. 2** illustrates a schematic for a driver arrangement **200** for the arrangement of color emitter sub-pixels in **FIGS. 1A, 1B**, and **1C**. For convenience, the example given has the same number of sub-pixels illustrated as **FIG. 1C**. This drive arrangement may be used for a number of display technologies, as the blocks **210** may represent one or several electrical components, which are not shown so as not to obscure the embodiments. In particular, they may represent the capacitive display cell element for passively addressed Liquid Crystal Display (LCD), or ElectroLuminescent (EL)

Display. They may represent the gaseous discharge element in a Plasma Display Panel (PDP). They may represent the semiconductor diode element of a passively addressed Inorganic Light Emitting Diode or an Organic Light Emitting Diode Display. They may also represent the transistor, storage capacitor, and capacitive cell element of an Active Matrix Liquid Crystal Display (AMLCD). They may further represent the multi-transistor, storage capacitor, and light emitting element of an Active Matrix Organic Light Emitting Diode Display (AMOLED). They may also represent, in general, the color sub-pixel and its associated electronic elements found in other known or yet to be developed display technologies.

[0041] The drive timing and method may be any of those known in the art for N×M drive matrices as those shown. However, there may be modifications needed due to the specific color assignments, particularly any checkerboard across the panel or color alternations within a single column. For example, the technique known in the art as "Multi-Row Addressing" or "Multi-Line Addressing" for passive LCD may be modified such that groupings of rows are restricted to odd and even row combinations. This will reduce potential color crosstalk since, within a column with two alternating color sub-pixels, only one color will be addressed at a time.

[0042] Inversion schemes, switching the electrical field polarity across the display cell to provide a time averaged zero net field and ion current across the cell, can be applied to the embodiments disclosed herein. **FIGS. 3A and 3B** show two "dot inversion" schemes **300** and **310**, referred to as "1×1" and "2×1", respectively, on Active Matrix Liquid Crystal Displays, both of which will perform satisfactorily. The scheme shown on **FIG. 3B** may perform better when slight imbalances of light transmission occur between positive and negative polarities, especially when the eye is tracking the motion of displayed images moving across the screen. Each of the Figures shows the polarities during half of the display addressing fields. The polarities are reversed for the other half, alternating every field, resulting in a net zero current (zero DC bias), as is well known in the art.

[0043] Data Format Conversion

[0044] For one embodiment of data format conversion using area resampling techniques, **FIGS. 4A, 4B**, and **4C** illustrate green **406**, blue **402**, and red **404** resample area arrays for the green, blue, and red color planes, respectively. Note that each color resample area array **406, 402**, and **404** consists of resample areas **426, 422**, and **424** and that each resample area has an associated resample point **416, 412**, and **414**, respectively, associated with it. The resample points **416, 412**, and **414** match the relative positions of the green **106**, blue **102**, and red **104** sub-pixel locations respectively, within each color plane; but not necessarily their exact inter-color-plane-phase relationships. It should be appreciated that any number of phase relationships are also possible.

[0045] **FIG. 4D** illustrates one particular inter-color-plane-phase relationship **400**. This relationship might be employed to convert the conventional fully converged square grid RGB format which is to be displayed "one-to-one" with the square green **106** sub-pixel grid of **FIG. 1C**. In this inter-color-plane-phase relationship **400**, the green **406**, blue **402**, and red **404** resample area arrays are substantially positioned such that the red **414** and blue **412** resample points overlap the green **416** sample points. This

treats the green sub-pixels **106** as though they lay on top of, or intimately associated with, the red **104** and blue **102** sub-pixel checkerboard.

[0046] FIGS. 5A, 5B, and 5C illustrate the green **406**, blue **402**, and red **404** resample area arrays of FIGS. 4A, 4B, and 4C overlaid on the sub-pixel arrangement **100** of FIG. 1C, respectively, with the inter-color-plane-phase relationship **400** of FIG. 4D. FIG. 5D illustrates the inter-color-plane-phase relationship **400** of FIG. 4D overlaid on the sub-pixel arrangement **100** of FIG. 1C. These Figures are merely illustrative and only serve to provide an understanding of the relationship between the resample points, reconstruction points, resample areas, and sub-pixel locations for this embodiment.

[0047] The above referenced '355 patent application describes the method used to convert the incoming data format to that suitable for the display. In such a case, the method proceeds as follows: (1) determining implied sample areas for each data point of incoming three-color pixel data; (2) determining the resample area for each color sub-pixel in the display; (3) forming a set of coefficients for each the resample area, said coefficients comprising fractions whose denominators are a function of the resample area and the numerators are a function of an area of each the implied sample areas that may partially overlap said resample areas; (4) multiplying the incoming pixel data for each implied sample area by the coefficient resulting in a product; (5) adding each the product to obtain luminance values for each resample area.

[0048] Examining a "one-to-one" format conversion case for the resample operation illustrated in FIGS. 4D and 5D, the green plane conversion is a unity filter. The red and blue color planes use a 3x3 filter coefficient matrix, derived as explained in detail in the '355 application:

0	0.125	0
0.125	0.5	0.125
0	0.125	0

[0049] FIG. 5E illustrates the results of turning on two full color incoming data pixels. The two pixels are converted to two clusters of sub-pixels, called "logical pixels" **500**, turned on at varying amplitudes. One of the logical pixels is centered on or near a red sub-pixel **104**. The green sub-pixel **106** is set at 100% illumination. The red sub-pixel **104** is set to 50% illumination, while the four surrounding blue sub-pixels **102** are set to 12.5% each. The result is a white dot visible to the human eye, centered between the red **104** and the green **106** sub-pixels. The other logical pixel **500** similarly has the green sub-pixel **106** set to 100% and the near by blue sub-pixel **102** set to 50% with the four surrounding red sub-pixels **104** set at 12.5% each.

[0050] FIGS. 6B and 6C show an alternative blue **602** and red **604** color plane resample area arrays—shown herein as box filters ([0.5 0.5])—to replace the blue **402** and red **404** resample area arrays of FIGS. 4B and 4C, respectively. FIG. 6D illustrates an inter-color-plane-phase relationship **610** using the green **406**, blue **602**, and red **604** resample area arrays. FIG. 6A shows the resulting logical pixels **600** from turning on two input data format pixels using resample

operation of the inter-color-plane-phase relationship **610** from input data with a "one-to-one" pixel to green sub-pixel **106** mapping. These logical pixels **600** may be in the same relative positions as the two logical pixels **500** in FIG. 5E. Also, it may be possible to center the green box filter to match substantially an input pixel by adjusting the grid slightly.

[0051] Adaptive filtering techniques can also be implemented with the pixel arrangements disclosed herein, as further described below.

[0052] Again, the green resample uses a unitary filter. The red and blue color planes use a very simple 1x2 coefficient filter: [0.5 0.5]

[0053] An adaptive filter, similar to that disclosed in the co-pending and commonly assigned U.S. patent application Ser. No. 10/215,843 ("the '843 application"), entitled "METHODS AND SYSTEMS FOR SUB-PIXEL RENDERING WITH ADAPTIVE FILTERING," filed on Aug. 8, 2002, which is hereby incorporated herein by reference, can be adopted so as not to require a 3x3 sample of input data, which uses a minimum of two lines of memory. The test may be based on a smaller sample of input data, for example 1x3 or 1x2 matrices. The green data is sampled to test for vertical or diagonal lines and then the red and blue data adjacent to the green test point may be changed.

[0054] So, an adaptive filter test could be implemented as follows to test to see if a high contrast edge is detected: compare the green data (G) to a min value and a max value—if G<min or G>max, then a register value is set to 1, otherwise the register value is set to 0; compare the register values for three successive green data points to test masks to see if an edge is detected; if detected then take an appropriate action to the red and/or blue data—e.g. apply gamma or apply a new value or different filter coefficient.

[0055] The following table is illustrative of this embodiment:

Data (for 3 successive points)	0.98	0.05	0.0
Low Test (G < 0.1)	0	1	1
High Test (G > 0.9)	1	0	0
Compare low and NOT high	True	True	True

[0056] For the example above, an edge has been detected and there is an array of options and/or actions to take at this point. For example, the gamma correction could be applied to the output of the box filter for red and/or blue; or a new fixed value representing the output required to balance color could be used; or use a new SPR filter.

[0057] The test for black lines, dots, edges and diagonal lines are similar in this case, since only three values are examined:

	Register Value			Binary no.
1.	1	0	1	5
2.	1	1	0	6
3.	0	1	1	3

[0058] In the above table, the first row could represent a black pixel with white pixels on either side. The second row could represent an edge of a black line or dot. The third row could represent an edge of a black line in a different location. The binary numbers are used as an encoding for the test.

[0059] The test for white lines, dots, edges, and diagonal lines might be as follows: Register value Binary no.

	Register value			Binary no.
4.	0	1	0	2
5.	0	0	1	1
6.	1	0	0	4

[0060] If the tests are true and the high and low tests are, for example, 240 and 16 (out of 255) respectively, then the output value for these edges using the box filter might be 128 ± 4 —or some other suitable value. The pattern matching is to the binary numbers shown adjacent to the register values. A simple replacement of 128 raised to an appropriate gamma power could be output to the display. For example, for $\gamma=2.2$, the output value is approximately 186. Even though the input may vary, this is just an edge correction term so a fixed value can be used without noticeable error. Of course, for more precision, a gamma lookup table could likewise be used. It should be appreciated that a different value, but possibly similar, of correction could be used for white and black edges. It should likewise be appreciated that as a result of detecting an edge, the red and/or blue data could be acted on by a different set of filter coefficients—e.g. apply a [1 0] filter (i.e. unity filter) which would effectively turn off sub pixel rendering for that pixel value.

[0061] The above tests were primarily for a green test, followed by action on red and blue. Alternatively, the red and blue can be tested separately and actions taken as needed. If one desired to only apply the correction for black and white edges, than all three color data sets can be tested and the result ANDed together.

[0062] A further simplification could be made as follows. If only two pixels in a row are tested for edges, then the test above is further simplified. High and low thresholding may still be accomplished. If [0 1] or [1 0] is detected, then a new value could be applied—otherwise the original value could be used.

[0063] Yet another simplification could be accomplished as follows (illustrated for the red): subtract the red data value, R_n , from the red value immediately to the left, R_{n-1} ; if the delta is greater than a predetermined number—say for example 240—then an edge is detected. If an edge is detected, one could substitute a new value, or apply gamma, output the value R_n to the display, or apply new SPR filter coefficients; otherwise, if no edge is detected, output the results of the box filter to the display. As either R_n or R_{n-1} may be larger, the absolute value of the delta could be tested. The same simplification could occur for the blue; but the green does not need to be tested or adjusted, if green is the split pixel in the grouping. Alternatively, a different action could be taken for falling edges (i.e. $R_n - R_{n-1} < 0$) and rising edges (i.e. $R_n - R_{n-1} > 0$).

[0064] The results are logical pixels 600 that have only three sub-pixels each. For a white dot and using a box filter for red and blue data, the green sub-pixels 106 are set to 100% as before. The nearby red 104, as well as the nearby blue 102, could be all set to 50%. The resample operation of inter-color-plane-phase relationship 610 of FIG. 6D is very simple and inexpensive to implement, while still providing good image quality.

[0065] Both of the above data format conversion methods match the human eye by placing the center of logical pixels at the numerically superior green sub-pixels. The green sub-pixels are each seen as the same brightness as the red sub-pixel, even though half as wide. Each green sub-pixel 106 acts as though it were half the brightness of the associated logical pixel at every location, while the rest of the brightness is associated with the nearby red sub-pixel illuminated. Thus, the green serves to provide the bulk of the high resolution luminance modulation, while the red and blue provide lower resolution color modulation, matching the human eye.

[0066] FIG. 7A illustrates an alternative inter-color-plane-phase relationship 700 using the green 406, blue 402, and red 404 resample area arrays of FIGS. 4A, 4B, and 4C. Note that in this inter-color-plane-phase relationship 700 has the same relative phase as the color sub-pixel arrangement 100 as illustrated in FIG. 7B. Note that the relative phases of the resample points of this inter-color-plane-phase relationship 700 is the same as that for the inter-color-plane-phase relationship 610. If this inter-color-plane-phase relationship 700 were used for the “one-to-one” data format conversion, the green would again be a unitary filter, while the red and blue would use 3x2 coefficient filter kernel:

0.0625	0.0625
0.375	0.375
0.0625	0.0625

[0067] Note that the two columns add up to 0.5 each, similar to the coefficients for the red and blue resample filter operation for the inter-color-plane-phase relationship 610.

[0068] This inter-color-plane-phase relationship 700 shown in FIG. 7A is useful for scaling, both up and down, of conventional format data sets. The area resample method of calculation of the filter coefficients and keeping track of the input and output data buffers was described in the referenced '355 application. However, according to another embodiment, while the red and blue color planes may be area resampled, it may be advantageous to calculate the filter coefficients for the square grid of green sub-pixels 106 using a novel implementation of a bi-cubic interpolation algorithm for scaling up data sets while converting them to be displayed on the arrangement of color sub-pixels 100 of FIG. 1C.

[0069] FIG. 10 depicts a system 1000 in which a display as constructed in accordance with the various embodiments disclosed herein is driven by a sub-pixel rendering technique 1004 which may be resident on a physical device 1002. An input image data stream 1008 may be input into the sub-pixel rendering technique 1004 and converted in the manner herein disclosed. An output image data stream 1010 is sent

to the display device **1006** in order to drive the various sub-pixels to form an image thereupon. As discussed in several references incorporated herein, the sub-pixel rendering (SPR) technique **1004** may be implemented in either hardware and/or software or a combination thereof. For example, SPR techniques **1004** could be resident as logic (either hardware or software) on the display itself or it could reside on a graphics controller chip or board.

[**0070**] **FIGS. 11A and 11B** depict two particular flow-chart embodiments disclosing sub-pixel rendering in software and hardware respectively. In **FIG. 11A**, SPR may be accomplished in advance on a PC or other processing system and/or means. From there, the pre-rendered images could be downloaded to a controller/interface and sent along to a drive running the display. In **FIG. 11B**, image data may be input from many different sources—for example, a notebook PC with DVI output or a desktop with DVI output—to a hardware module doing SPR. From there, the sub-pixel rendered data could be sent ultimately to the display via a controller/interface and a drive. Of course, other hardware and software implementations are possible and that **FIGS. 11A and 11B** merely describe two possible such implementations.

[**0071**] **FIG. 12** shows one particular display embodiment for a 320×320 STN display using the sub-pixel repeat cell as disclosed herein. Although various sub-pixel dimensions are also disclosed in **FIG. 12**, it should be appreciated that other dimensions would also suffice and that **FIG. 12** is merely offered for illustrative purposes for a single embodiment.

[**0072**] While the invention has been described with reference to exemplary embodiments, it will be understood that various changes may be made and equivalents may be substituted for elements thereof without departing from the scope of the invention. In addition, many modifications may be made to adapt a particular situation or material to the teachings without departing from the essential scope thereof. For example, some of the embodiments above may be implemented in other display technologies such as Organic Light Emitting Diode (OLED), ElectroLuminescent (EL), Electrophoretic, Active Matrix Liquid Crystal Display (AMLCD), Passive Matrix Liquid Crystal display (AMLCD), Incandescent, solid state Light Emitting Diode (LED), Plasma Display Panel (PDP), and Iridescent. Therefore, it is intended that the invention not be limited to the particular embodiment disclosed as the best mode contemplated for carrying out this invention, but that the invention will include all embodiments falling within the scope of the appended claims.

1. A display comprising a plurality of a sub-pixel group; said sub-pixel group further comprising eight sub-pixels;

wherein each said sub-pixel is one of a first color sub-pixel, a second color sub-pixel and a third color sub-pixel;

wherein said sub-pixel group further comprises four sub-pixels of said first color, two sub-pixels of said second color and two sub-pixels of said third color;

wherein further said sub-pixels of said second color and said sub-pixels of said third color form substantially a checkerboard pattern.

2. The display as recited in claim 1 wherein said first color comprises a green color and each said second color and said third color comprises one of a red color and a blue color, respectively.

3. The display as recited in claim 1 wherein said first color comprises a red color and each said second color and said third color is one of a green color and a blue color, respectively.

4. The display as recited in claim 1 wherein said sub-pixels of said first color comprises a smaller area than said sub-pixels of said second color and said third color.

5. The display as recited in claim 1 where said sub-pixel group further comprises substantially two rows and four columns of sub-pixels; and

wherein further a first set of two non-adjacent columns comprise four sub-pixels of said first color and a second set of two non-adjacent columns comprise two sub-pixels of said second color and two sub-pixels of said third color.

6. The display as recited in claim 5 wherein said two non-adjacent columns comprising four sub-pixels of said first color are offset vertically from said two non-adjacent columns comprise two sub-pixels of said second color and two sub-pixels of said third color.

7. The display as recited in claim 1 wherein said sub-pixels of said first color are interspersed said substantially formed checkerboard pattern of sub-pixels of said second color and said third color.

8. The display as recited in claim 1 wherein said display is an active matrix liquid crystal display.

9. The display as recited in claim 8 wherein said display applies a dot inversion scheme for driving the sub-pixels in each sub-pixel group.

10. The display as recited in claim 9 wherein said dot inversion scheme is 1×1 dot inversion.

11. The display as recited in claim 9 wherein said dot inversion scheme is 2×1 dot inversion.

12. In a display, said display comprising a plurality of a sub-pixel group; said sub-pixel group further comprising eight sub-pixels; wherein each said sub-pixel is one of a first color sub-pixel, a second color sub-pixel and a third color sub-pixel; wherein said sub-pixel group further comprises four sub-pixels of said first color, two sub-pixels of said second color and two sub-pixels of said third color; wherein further said sub-pixels of said second color and said sub-pixels of said third color form substantially a checkerboard pattern;

a method of converting a source pixel data of a first format for rendering onto said display comprising:

determining implied sample areas for each data point of incoming three-color pixel data;

determining the resample area for each color sub-pixel in the display;

forming a set of coefficients for each the resample area, said coefficients comprising fractions whose denominators are a function of the resample area and the numerators are a function of an area of each the implied sample areas that may partially overlap said resample areas;

multiplying the incoming pixel data for each implied sample area by the coefficient resulting in a product; and

adding each the product to obtain luminance values for each resample area.

13. The method as recited in claim 12 wherein determining the resample area further comprises:

determining a phase relationship between the resample area for each color sub-pixel.

14. The methods as recited in claim 13 wherein determining a phase relationship further comprises:

positioning resample points for each said color resample areas such that the resample points for said second color and said third color substantially overlay the resample points for said first color.

15. The method as recited in claim 12 wherein said first color is green, and said second and third colors are red and blue respectively;

wherein said green color plane conversion comprises a unity filter and the red and blue color plane use a 3×3 filter coefficient matrix.

16. The method as recited in claim 15 wherein said green color plane comprises a unity filter centered to match substantially an input pixel by adjusting said filter with respect to the sub-pixel grid.

17. In a display, said display comprising a plurality of a sub-pixel group; said sub-pixel group further comprising eight sub-pixels; wherein each said sub-pixel is one of a first color sub-pixel, a second color sub-pixel and a third color sub-pixel; wherein said sub-pixel group further comprises four sub-pixels of said first color, two sub-pixels of said second color and two sub-pixels of said third color; wherein further said sub-pixels of said second color and said sub-pixels of said third color form substantially a checkerboard pattern;

a method of converting a source pixel data of a first format for rendering onto said display comprising:

inputting a set of color image data;

testing the input data for a plurality of conditions; and

taking appropriate actions in response to the outcome of said testing of the input data.

18. The method as recited in claim 17 wherein said set of color image input data comprises a sample of a 1×3 matrix of input data.

19. The method as recited in claim 17 wherein said set of color image input data comprises a sample of a 1×2 matrix of input data.

20. The method as recited in claim 17 wherein testing the input data for a plurality of conditions further comprises:

testing for the detection of a high contrast feature in the input data.

21. The method as recited in claim 20 wherein said high contrast feature comprises one of a group, said group comprising an edge, a line, and a dot.

22. The method as recited in claim 17 wherein taking appropriate actions in response to the outcome of said testing of the input data further comprises:

substitute a new color data value for the current color data value.

23. The method as recited in claim 17 wherein taking appropriate actions in response to the outcome of said testing of the input data further comprises:

apply gamma correction to the current color data value.

24. The method as recited in claim 17 wherein taking appropriate actions in response to the outcome of said testing of the input data further comprises:

apply new sub-pixel rendering filter coefficients to the input data.

25. A system comprising:

a display, said display comprising a plurality of a sub-pixel group; said sub-pixel group further comprising eight sub-pixels; wherein each said sub-pixel is one of a first color sub-pixel, a second color sub-pixel and a third color sub-pixel; wherein said sub-pixel group further comprises four sub-pixels of said first color, two sub-pixels of said second color and two sub-pixels of said third color; wherein further said sub-pixels of said second color and said sub-pixels of said third color form substantially a checkerboard pattern; and

means for subpixel rendering input image data.

26. The system as recited in claim 25 wherein said means for subpixel rendering input data further comprises:

means for inputting a set of color image data;

means for testing the input data for a plurality of conditions; and

means for taking appropriate actions in response to the outcome of said testing of the input data.

27. The system as recited in claim 26 wherein said set of color image input data comprises a sample of a 1×3 matrix of input data.

28. The system as recited in claim 26 wherein said set of color image input data comprises a sample of a 1×2 matrix of input data.

29. The system as recited in claim 26 wherein said means for testing the input data for a plurality of conditions further comprises:

means for testing for the detection of a high contrast feature in the input data.

30. The system as recited in claim 29 wherein said high contrast feature comprises one of a group, said group comprising an edge, a line, and a dot.

31. The system as recited in claim 26 wherein means for taking appropriate actions in response to the outcome of said testing of the input data further comprises:

means for substituting a new color data value for the current color data value.

32. The system as recited in claim 26 wherein means for taking appropriate actions in response to the outcome of said testing of the input data further comprises:

means for applying gamma correction to the current color data value.

33. The system as recited in claim 26 wherein means for taking appropriate actions in response to the outcome of said testing of the input data further comprises:

means for applying new sub-pixel rendering filter coefficients to the input data.

34. The system as recited in claim 25 wherein said means for subpixel rendering input data further comprises:

means for determining implied sample areas for each data point of incoming three-color pixel data;

means for determining the resample area for each color sub-pixel in the

means for forming a set of coefficients for each the resample area, said coefficients comprising fractions whose denominators are a function of the resample area and the numerators are a function of an area of each the implied sample areas that may partially overlap said resample areas;

means for multiplying the incoming pixel data for each implied sample area by the coefficient resulting in a product; and

means for adding each the product to obtain luminance values for each resample area.

35. The system as recited in claim 34 wherein means for determining the resample area further comprises:

means for determining a phase relationship between the resample area for each color sub-pixel.

36. The system as recited in claim 35 wherein means for determining a phase relationship further comprises:

means for positioning resample points for each said color resample areas such that the resample points for said second color and said third color substantially overlay the resample points for said first color.

37. The system as recited in claim 34 wherein said first color is green, and said second and third colors are red and blue respectively;

wherein said green color plane conversion comprises a unity filter and the red and blue color plane use a 3x3 filter coefficient matrix.

38. The system as recited in claim 37 wherein said green color plane comprises a unity filter centered to match substantially an input pixel by adjusting said filter with respect to the sub-pixel grid.

* * * * *