

Under the Paperwork Reduction Act of 1995, no persons are required to respond to a collection of information unless it contains a valid OMB control number.

Application Data Sheet 37 CFR 1.76		Attorney Docket Number	56503-149126
		Application Number	
Title of Invention	Shoe Midsole		
The application data sheet is part of the provisional or nonprovisional application for which it is being submitted. The following form contains the bibliographic data arranged in a format specified by the United States Patent and Trademark Office as outlined in 37 CFR 1.76. This document may be completed electronically and submitted to the Office in electronic format using the Electronic Filing System (EFS) or the document may be printed and included in a paper filed application.			

Secrecy Order 37 CFR 5.2

Portions or all of the application associated with this Application Data Sheet may fall under a Secrecy Order pursuant to 37 CFR 5.2 (Paper filers only. Applications that fall under Secrecy Order may not be filed electronically.)

Inventor Information:

Inventor 1					<input type="button" value="Remove"/>
Legal Name					
Prefix	Given Name	Middle Name	Family Name	Suffix	
	Jack		Boys		
Residence Information (Select One) <input checked="" type="radio"/> US Residency <input type="radio"/> Non US Residency <input type="radio"/> Active US Military Service					
City	Greenland	State/Province	NH	Country of Residence ⁱ	US
Mailing Address of Inventor:					
Address 1	c/o Cole Haan LLC				
Address 2	150 Ocean Road				
City	Greenland	State/Province	NH		
Postal Code	03840	Country ⁱ	US		
All Inventors Must Be Listed - Additional Inventor Information blocks may be generated within this form by selecting the Add button.					<input type="button" value="Add"/>

Correspondence Information:

Enter either Customer Number or complete the Correspondence Information section below. For further information see 37 CFR 1.33(a).		
<input type="checkbox"/> An Address is being provided for the correspondence information of this application.		
Customer Number	21888	
Email Address	ipdocket@thompsoncoburn.com	<input type="button" value="Add Email"/> <input type="button" value="Remove Email"/>

Application Information:

Title of the Invention	Shoe Midsole		
Attorney Docket Number	56503-149126	Small Entity Status Claimed	<input type="checkbox"/>
Application Type	Nonprovisional		
Subject Matter	Design		
Total Number of Drawing Sheets (if any)	6	Suggested Figure for Publication (if any)	
Filing By Reference :			

Under the Paperwork Reduction Act of 1995, no persons are required to respond to a collection of information unless it contains a valid OMB control number.

Application Data Sheet 37 CFR 1.76		Attorney Docket Number	56503-149126
		Application Number	
Title of Invention	Shoe Midsole		

Only complete this section when filing an application by reference under 35 U.S.C. 111(c) and 37 CFR 1.57(a). Do not complete this section if application papers including a specification and any drawings are being filed. Any domestic benefit or foreign priority information must be provided in the appropriate section(s) below (i.e., "Domestic Benefit/National Stage Information" and "Foreign Priority Information").

For the purposes of a filing date under 37 CFR 1.53(b), the description and any drawings of the present application are replaced by this reference to the previously filed application, subject to conditions and requirements of 37 CFR 1.57(a).

Application number of the previously filed application	Filing date (YYYY-MM-DD)	Intellectual Property Authority or Country

Publication Information:

Request Early Publication (Fee required at time of Request 37 CFR 1.219)

Request Not to Publish. I hereby request that the attached application not be published under 35 U.S.C. 122(b) and certify that the invention disclosed in the attached application **has not and will not** be the subject of an application filed in another country, or under a multilateral international agreement, that requires publication at eighteen months after filing.

Representative Information:

Representative information should be provided for all practitioners having a power of attorney in the application. Providing this information in the Application Data Sheet does not constitute a power of attorney in the application (see 37 CFR 1.32). Either enter Customer Number or complete the Representative Name section below. If both sections are completed the customer Number will be used for the Representative Information during processing.

Please Select One:	<input checked="" type="radio"/> Customer Number	<input type="radio"/> US Patent Practitioner	<input type="radio"/> Limited Recognition (37 CFR 11.9)
Customer Number	21888		

Domestic Benefit/National Stage Information:

This section allows for the applicant to either claim benefit under 35 U.S.C. 119(e), 120, 121, 365(c), or 386(c) or indicate National Stage entry from a PCT application. Providing this information in the application data sheet constitutes the specific reference required by 35 U.S.C. 119(e) or 120, and 37 CFR 1.78.

When referring to the current application, please leave the application number blank.

Prior Application Status		<input type="button" value="Remove"/>	
Application Number	Continuity Type	Prior Application Number	Filing Date (YYYY-MM-DD)
Additional Domestic Benefit/National Stage Data may be generated within this form by selecting the Add button.			<input type="button" value="Add"/>

Foreign Priority Information:

Under the Paperwork Reduction Act of 1995, no persons are required to respond to a collection of information unless it contains a valid OMB control number.

Application Data Sheet 37 CFR 1.76		Attorney Docket Number	56503-149126
		Application Number	
Title of Invention	Shoe Midsole		

This section allows for the applicant to claim priority to a foreign application. Providing this information in the application data sheet constitutes the claim for priority as required by 35 U.S.C. 119(b) and 37 CFR 1.55. When priority is claimed to a foreign application that is eligible for retrieval under the priority document exchange program (PDX) the information will be used by the Office to automatically attempt retrieval pursuant to 37 CFR 1.55(i)(1) and (2). Under the PDX program, applicant bears the ultimate responsibility for ensuring that a copy of the foreign application is received by the Office from the participating foreign intellectual property office, or a certified copy of the foreign priority application is filed, within the time period specified in 37 CFR 1.55(g)(1).

Application Number	Country ⁱ	Filing Date (YYYY-MM-DD)	Access Code ⁱ (if applicable)

Additional Foreign Priority Data may be generated within this form by selecting the **Add** button.

Statement under 37 CFR 1.55 or 1.78 for AIA (First Inventor to File) Transition Applications

This application (1) claims priority to or the benefit of an application filed before March 16, 2013 and (2) also contains, or contained at any time, a claim to a claimed invention that has an effective filing date on or after March 16, 2013.

NOTE: By providing this statement under 37 CFR 1.55 or 1.78, this application, with a filing date on or after March 16, 2013, will be examined under the first inventor to file provisions of the AIA.

Authorization to Permit Access:

Authorization to Permit Access to the Instant Application by the Participating Offices

Under the Paperwork Reduction Act of 1995, no persons are required to respond to a collection of information unless it contains a valid OMB control number.

Application Data Sheet 37 CFR 1.76		Attorney Docket Number	56503-149126
		Application Number	
Title of Invention	Shoe Midsole		

If checked, the undersigned hereby grants the USPTO authority to provide the European Patent Office (EPO), the Japan Patent Office (JPO), the Korean Intellectual Property Office (KIPO), the World Intellectual Property Office (WIPO), and any other intellectual property offices in which a foreign application claiming priority to the instant patent application is filed access to the instant patent application. See 37 CFR 1.14(c) and (h). This box should not be checked if the applicant does not wish the EPO, JPO, KIPO, WIPO, or other intellectual property office in which a foreign application claiming priority to the instant patent application is filed to have access to the instant patent application.

In accordance with 37 CFR 1.14(h)(3), access will be provided to a copy of the instant patent application with respect to: 1) the instant patent application-as-filed; 2) any foreign application to which the instant patent application claims priority under 35 U.S.C. 119(a)-(d) if a copy of the foreign application that satisfies the certified copy requirement of 37 CFR 1.55 has been filed in the instant patent application; and 3) any U.S. application-as-filed from which benefit is sought in the instant patent application.

In accordance with 37 CFR 1.14(c), access may be provided to information concerning the date of filing this Authorization.

Applicant Information:

Providing assignment information in this section does not substitute for compliance with any requirement of part 3 of Title 37 of CFR to have an assignment recorded by the Office.			
Applicant 1			<input type="button" value="Remove"/>
If the applicant is the inventor (or the remaining joint inventor or inventors under 37 CFR 1.45), this section should not be completed. The information to be provided in this section is the name and address of the legal representative who is the applicant under 37 CFR 1.43; or the name and address of the assignee, person to whom the inventor is under an obligation to assign the invention, or person who otherwise shows sufficient proprietary interest in the matter who is the applicant under 37 CFR 1.46. If the applicant is an applicant under 37 CFR 1.46 (assignee, person to whom the inventor is obligated to assign, or person who otherwise shows sufficient proprietary interest) together with one or more joint inventors, then the joint inventor or inventors who are also the applicant should be identified in this section.			
<input type="button" value="Clear"/>			
<input type="radio"/> Assignee	<input type="radio"/> Legal Representative under 35 U.S.C. 117	<input type="radio"/> Joint Inventor	
<input checked="" type="radio"/> Person to whom the inventor is obligated to assign.		<input type="radio"/> Person who shows sufficient proprietary interest	
If applicant is the legal representative, indicate the authority to file the patent application, the inventor is:			
Name of the Deceased or Legally Incapacitated Inventor : <input type="text"/>			
If the Applicant is an Organization check here. <input checked="" type="checkbox"/>			
Organization Name	Cole Haan LLC		
Mailing Address Information For Applicant:			
Address 1	45 West 18th Street, Third Floor		
Address 2			
City	New York	State/Province	NY
Country ⁱ	US	Postal Code	10011
Phone Number		Fax Number	

Under the Paperwork Reduction Act of 1995, no persons are required to respond to a collection of information unless it contains a valid OMB control number.

Application Data Sheet 37 CFR 1.76		Attorney Docket Number	56503-149126		
		Application Number			
Title of Invention	Shoe Midsole				
Email Address					
Additional Applicant Data may be generated within this form by selecting the Add button.				<input type="button" value="Add"/>	

Assignee Information including Non-Applicant Assignee Information:

Providing assignment information in this section does not substitute for compliance with any requirement of part 3 of Title 37 of CFR to have an assignment recorded by the Office.

Assignee 1					
Complete this section if assignee information, including non-applicant assignee information, is desired to be included on the patent application publication. An assignee-applicant identified in the "Applicant Information" section will appear on the patent application publication as an applicant. For an assignee-applicant, complete this section only if identification as an assignee is also desired on the patent application publication.					
				<input type="button" value="Remove"/>	
If the Assignee or Non-Applicant Assignee is an Organization check here.				<input type="checkbox"/>	
Prefix	Given Name	Middle Name	Family Name	Suffix	
Mailing Address Information For Assignee including Non-Applicant Assignee:					
Address 1					
Address 2					
City		State/Province			
Country i		Postal Code			
Phone Number		Fax Number			
Email Address					
Additional Assignee or Non-Applicant Assignee Data may be generated within this form by selecting the Add button.				<input type="button" value="Add"/>	

Signature:

NOTE: This form must be signed in accordance with 37 CFR 1.33. See 37 CFR 1.4 for signature requirements and certifications.					
Signature	/alan h. norman/		Date (YYYY-MM-DD)	2015-10-13	
First Name	Alan	Last Name	Norman	Registration Number	32285
Additional Signature may be generated within this form by selecting the Add button.				<input type="button" value="Add"/>	

Under the Paperwork Reduction Act of 1995, no persons are required to respond to a collection of information unless it contains a valid OMB control number.

Application Data Sheet 37 CFR 1.76	Attorney Docket Number	56503-149126
	Application Number	
Title of Invention	Shoe Midsole	

This collection of information is required by 37 CFR 1.76. The information is required to obtain or retain a benefit by the public which is to file (and by the USPTO to process) an application. Confidentiality is governed by 35 U.S.C. 122 and 37 CFR 1.14. This collection is estimated to take 23 minutes to complete, including gathering, preparing, and submitting the completed application data sheet form to the USPTO. Time will vary depending upon the individual case. Any comments on the amount of time you require to complete this form and/or suggestions for reducing this burden, should be sent to the Chief Information Officer, U.S. Patent and Trademark Office, U.S. Department of Commerce, P.O. Box 1450, Alexandria, VA 22313-1450. DO NOT SEND FEES OR COMPLETED FORMS TO THIS ADDRESS. **SEND TO: Commissioner for Patents, P.O. Box 1450, Alexandria, VA 22313-1450.**

Privacy Act Statement

The Privacy Act of 1974 (P.L. 93-579) requires that you be given certain information in connection with your submission of the attached form related to a patent application or patent. Accordingly, pursuant to the requirements of the Act, please be advised that: (1) the general authority for the collection of this information is 35 U.S.C. 2(b)(2); (2) furnishing of the information solicited is voluntary; and (3) the principal purpose for which the information is used by the U.S. Patent and Trademark Office is to process and/or examine your submission related to a patent application or patent. If you do not furnish the requested information, the U.S. Patent and Trademark Office may not be able to process and/or examine your submission, which may result in termination of proceedings or abandonment of the application or expiration of the patent.

The information provided by you in this form will be subject to the following routine uses:

1. The information on this form will be treated confidentially to the extent allowed under the Freedom of Information Act (5 U.S.C. 552) and the Privacy Act (5 U.S.C. 552a). Records from this system of records may be disclosed to the Department of Justice to determine whether the Freedom of Information Act requires disclosure of these records.
2. A record from this system of records may be disclosed, as a routine use, in the course of presenting evidence to a court, magistrate, or administrative tribunal, including disclosures to opposing counsel in the course of settlement negotiations.
3. A record in this system of records may be disclosed, as a routine use, to a Member of Congress submitting a request involving an individual, to whom the record pertains, when the individual has requested assistance from the Member with respect to the subject matter of the record.
4. A record in this system of records may be disclosed, as a routine use, to a contractor of the Agency having need for the information in order to perform a contract. Recipients of information shall be required to comply with the requirements of the Privacy Act of 1974, as amended, pursuant to 5 U.S.C. 552a(m).
5. A record related to an International Application filed under the Patent Cooperation Treaty in this system of records may be disclosed, as a routine use, to the International Bureau of the World Intellectual Property Organization, pursuant to the Patent Cooperation Treaty.
6. A record in this system of records may be disclosed, as a routine use, to another federal agency for purposes of National Security review (35 U.S.C. 181) and for review pursuant to the Atomic Energy Act (42 U.S.C. 218(c)).
7. A record from this system of records may be disclosed, as a routine use, to the Administrator, General Services, or his/her designee, during an inspection of records conducted by GSA as part of that agency's responsibility to recommend improvements in records management practices and programs, under authority of 44 U.S.C. 2904 and 2906. Such disclosure shall be made in accordance with the GSA regulations governing inspection of records for this purpose, and any other relevant (i.e., GSA or Commerce) directive. Such disclosure shall not be used to make determinations about individuals.
8. A record from this system of records may be disclosed, as a routine use, to the public after either publication of the application pursuant to 35 U.S.C. 122(b) or issuance of a patent pursuant to 35 U.S.C. 151. Further, a record may be disclosed, subject to the limitations of 37 CFR 1.14, as a routine use, to the public if the record was filed in an application which became abandoned or in which the proceedings were terminated and which application is referenced by either a published application, an application open to public inspections or an issued patent.
9. A record from this system of records may be disclosed, as a routine use, to a Federal, State, or local law enforcement agency, if the USPTO becomes aware of a violation or potential violation of law or regulation.

SHOE MIDSOLE

PREAMBLE

Be it known that I have invented a new, original, and ornamental design for a shoe midsole of which the following is a specification, reference being had to the
5 accompanying drawing figures forming a part hereof.

DESCRIPTION OF THE DRAWINGS

Figure 1 is a perspective view of a shoe midsole showing the new design;

Figure 2 is a lateral side elevational view thereof;

10 Figure 3 is a medial side elevational view thereof;

Figure 4 is a bottom plan view thereof;

Figure 5 is a top plan view thereof;

Figure 6 is a front elevational view thereof; and

Figure 7 is a rear elevational view thereof.

15 The broken lines are for the purpose of illustrating environmental structure; the broken lines form no part of the claimed design.

I claim:

The ornamental design for a shoe midsole, as shown and described.

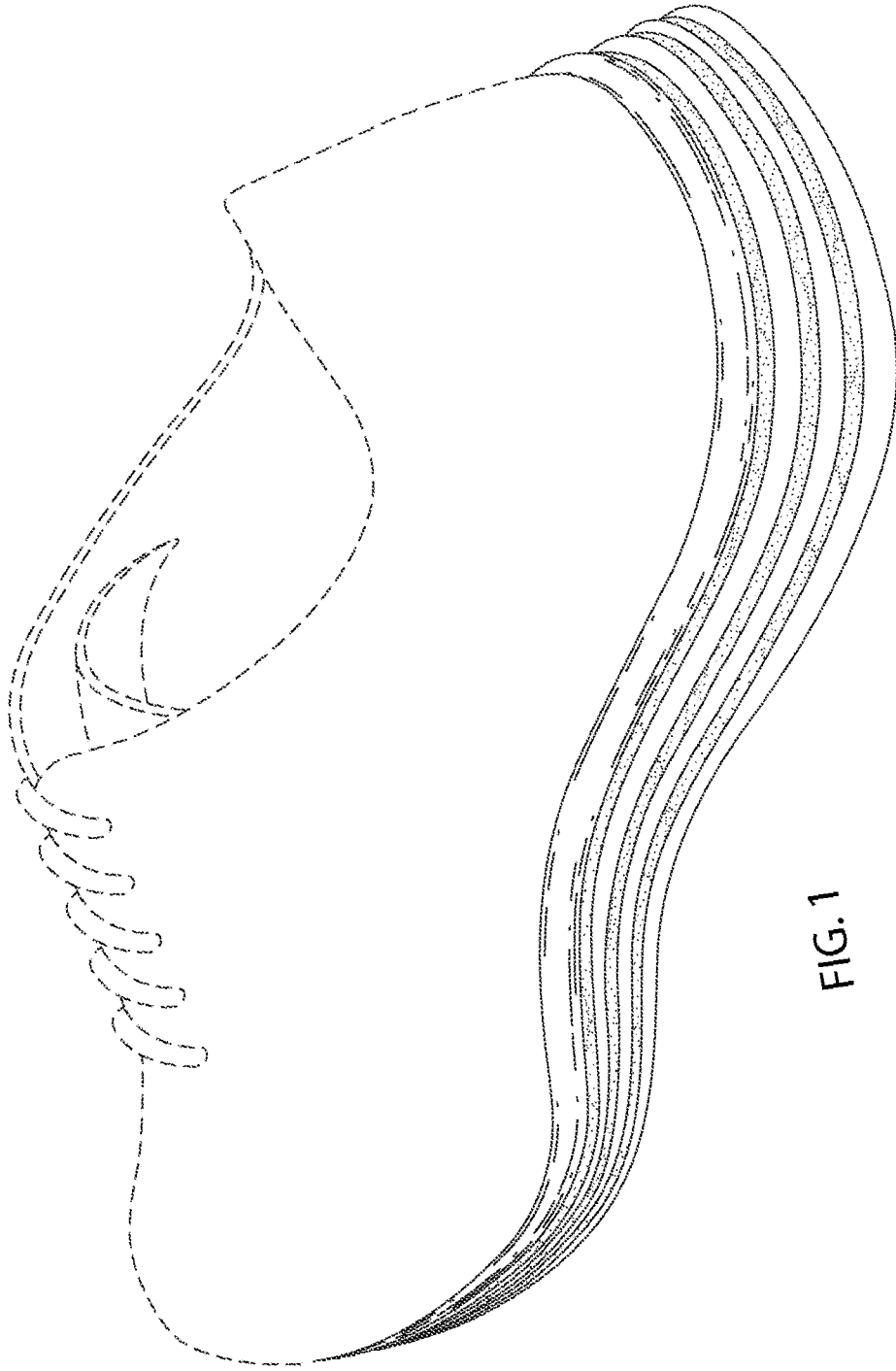

FIG. 1

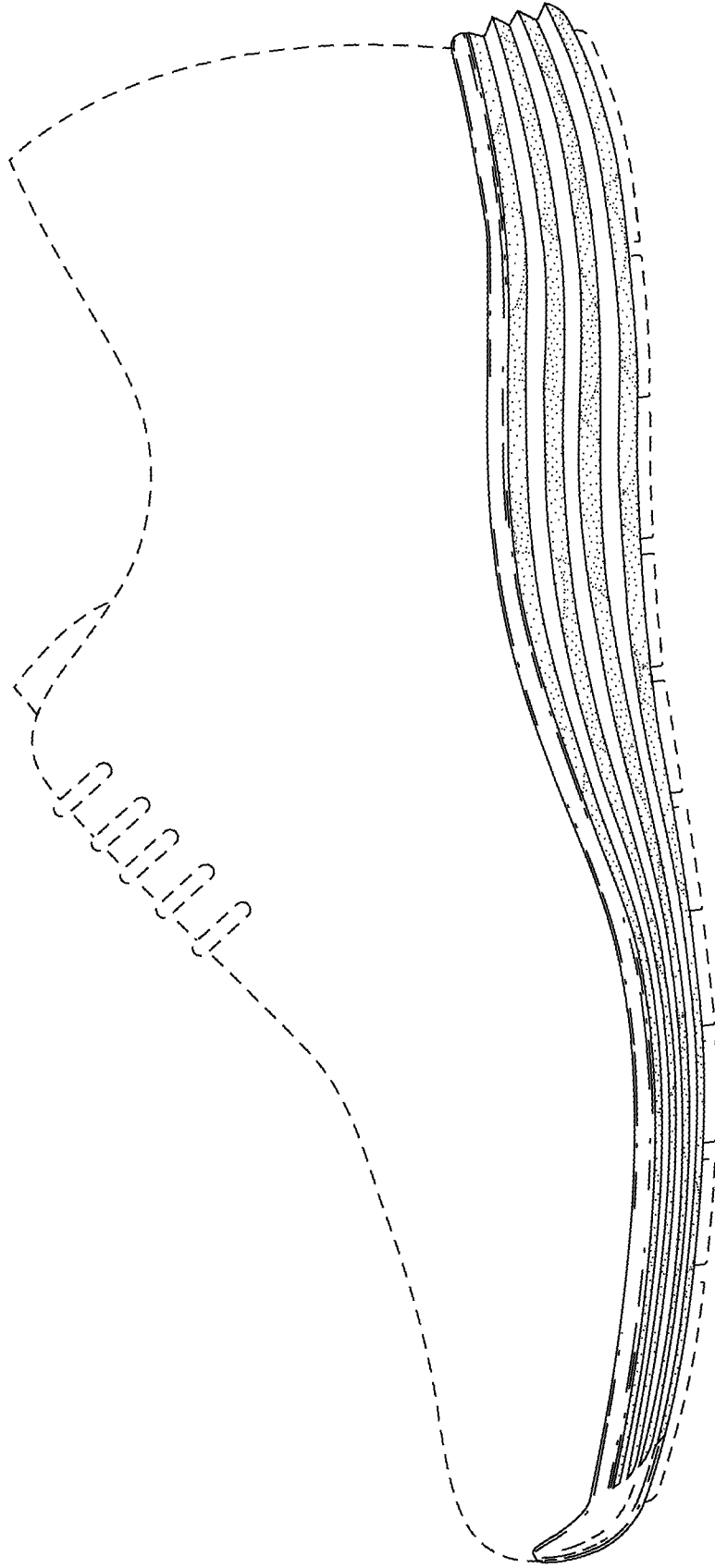

FIG. 2

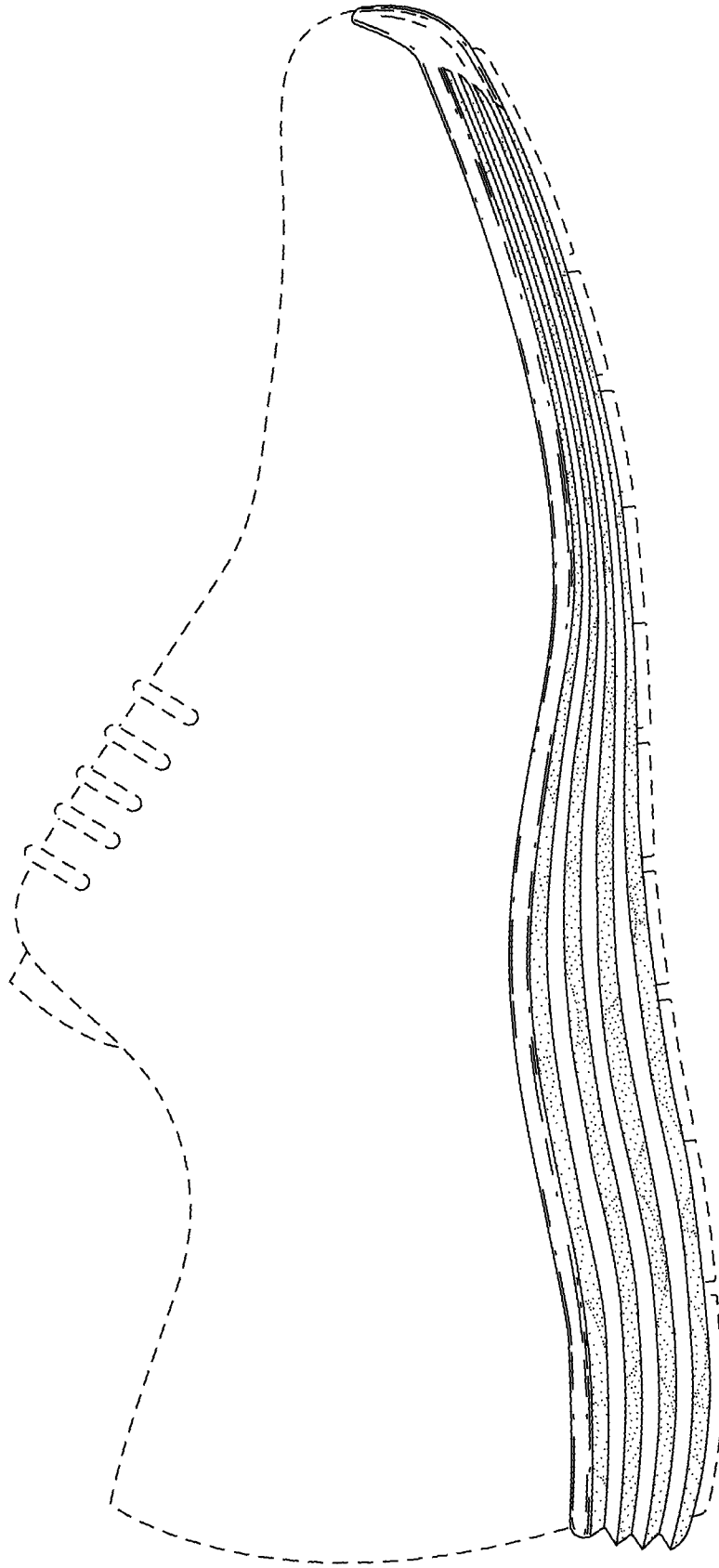

FIG. 3

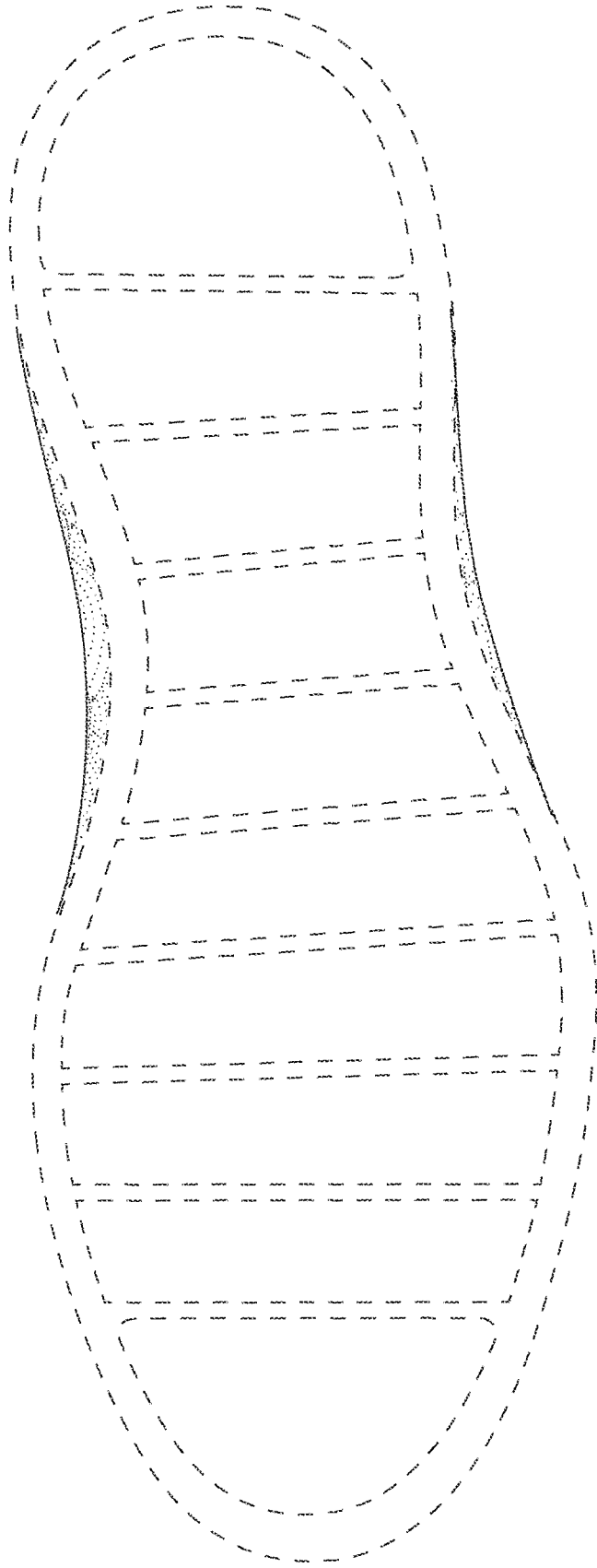

FIG.4

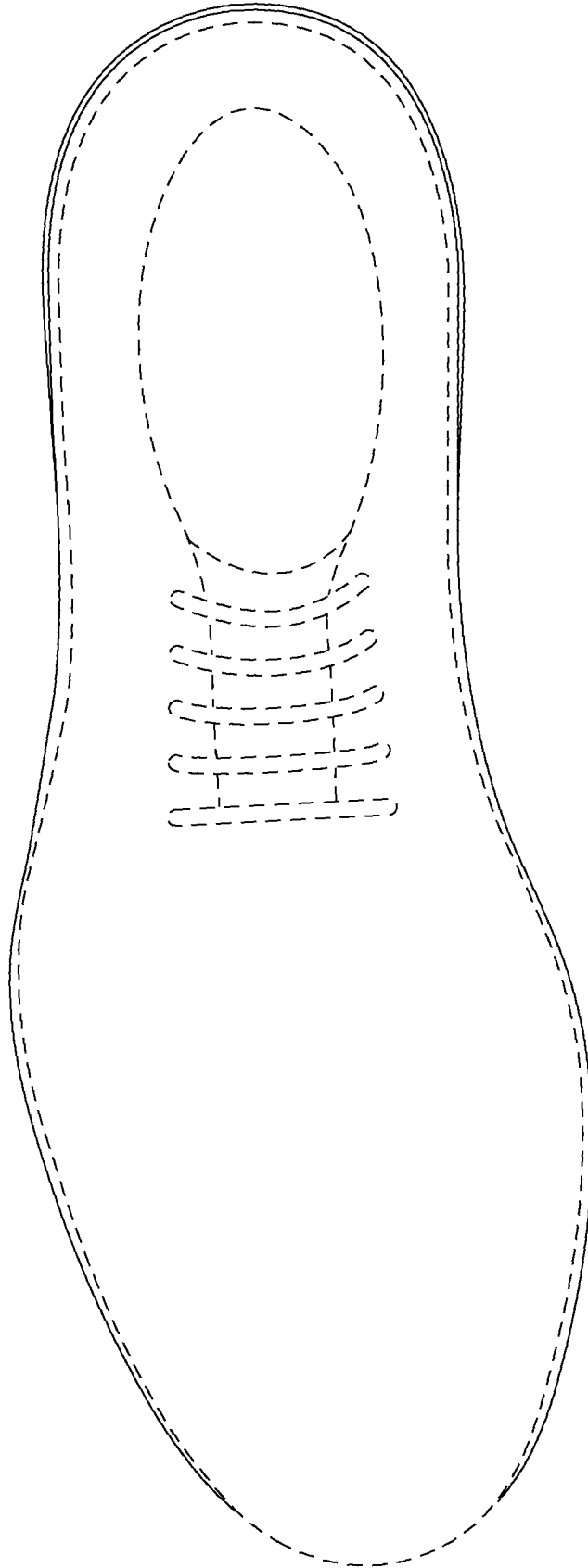

FIG. 5

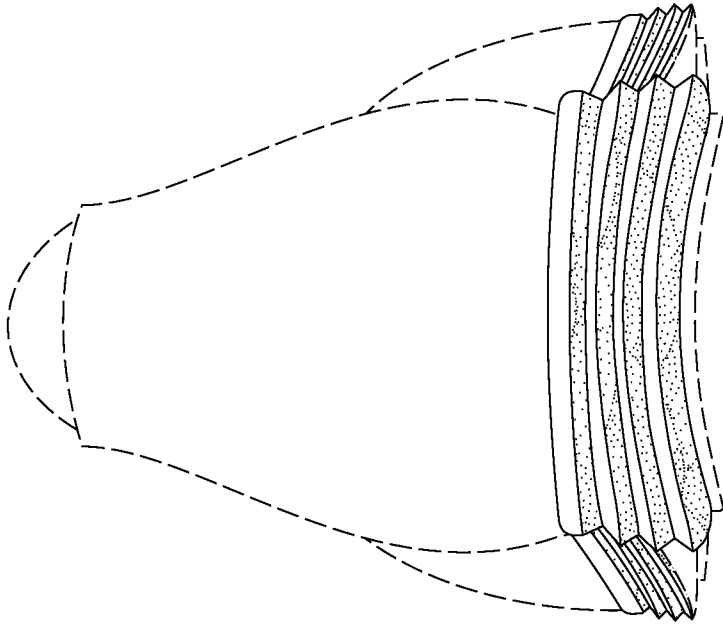

FIG. 7

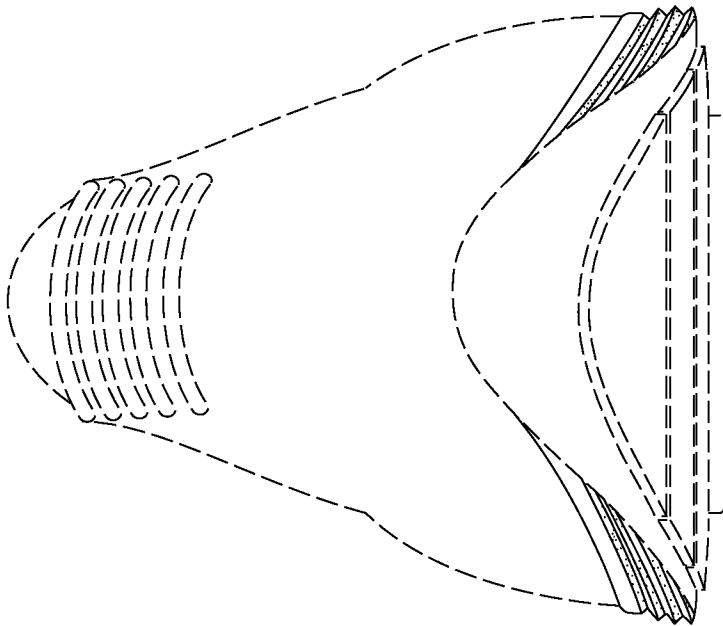

FIG. 6

Electronic Patent Application Fee Transmittal

Application Number:				
Filing Date:				
Title of Invention:	Shoe Midsole			
First Named Inventor/Applicant Name:	Jack Boys			
Filer:	Alan Norman/Laurie Poss			
Attorney Docket Number:	56503-149126			
Filed as Large Entity				
Filing Fees for Design				
Description	Fee Code	Quantity	Amount	Sub-Total in USD(\$)
Basic Filing:				
Design application filing	1012	1	180	180
Design Search Fee	1112	1	120	120
Design Examination	1312	1	460	460
Pages:				
Claims:				
Miscellaneous-Filing:				
Late Filing Fee for Oath or Declaration	1051	1	140	140
Petition:				

Description	Fee Code	Quantity	Amount	Sub-Total in USD(\$)
Patent-Appeals-and-Interference:				
Post-Allowance-and-Post-Issuance:				
Extension-of-Time:				
Miscellaneous:				
Total in USD (\$)				900

Electronic Acknowledgement Receipt

EFS ID:	23771678
Application Number:	29542318
International Application Number:	
Confirmation Number:	7943
Title of Invention:	Shoe Midsole
First Named Inventor/Applicant Name:	Jack Boys
Customer Number:	21888
Filer:	Alan Norman/Laurie Poss
Filer Authorized By:	Alan Norman
Attorney Docket Number:	56503-149126
Receipt Date:	13-OCT-2015
Filing Date:	
Time Stamp:	17:06:36
Application Type:	Design

Payment information:

Submitted with Payment	yes
Payment Type	Deposit Account
Payment was successfully received in RAM	\$900
RAM confirmation Number	4454
Deposit Account	200823
Authorized User	NORMAN, ALAN H

The Director of the USPTO is hereby authorized to charge indicated fees and credit any overpayment as follows:

Charge any Additional Fees required under 37 C.F.R. Section 1.16 (National application filing, search, and examination fees)

Charge any Additional Fees required under 37 C.F.R. Section 1.17 (Patent application and reexamination processing fees)

Charge any Additional Fees required under 37 C.F.R. Section 1.21 (Miscellaneous fees and charges)

File Listing:

Document Number	Document Description	File Name	File Size(Bytes)/ Message Digest	Multi Part /.zip	Pages (if appl.)
1	Application Data Sheet	ADS.pdf	1819130	no	7
			e3b01ee4858c620ef2290459e3bdfd070ae15f5b		
Warnings:					
Information:					
2	Specification	Specification-149126.pdf	63417	no	1
			4fb283ea9a4ff5b767633180a17ae14979508ec7		
Warnings:					
Information:					
3	Drawings-only black and white line drawings	56503-149126Drawings.pdf	4059959	no	6
			198bbb87a6f5df044333e9438a0e4a8a60780d8		
Warnings:					
The page size in the PDF is too large. The pages should be 8.5 x 11 or A4. If this PDF is submitted, the pages will be resized upon entry into the Image File Wrapper and may affect subsequent processing					
Information:					
4	Fee Worksheet (SB06)	fee-info.pdf	36246	no	2
			16d1093b7e03024c775a3fe2745fa43709c4e0fe		
Warnings:					
Information:					
Total Files Size (in bytes):			5978752		

This Acknowledgement Receipt evidences receipt on the noted date by the USPTO of the indicated documents, characterized by the applicant, and including page counts, where applicable. It serves as evidence of receipt similar to a Post Card, as described in MPEP 503.

New Applications Under 35 U.S.C. 111

If a new application is being filed and the application includes the necessary components for a filing date (see 37 CFR 1.53(b)-(d) and MPEP 506), a Filing Receipt (37 CFR 1.54) will be issued in due course and the date shown on this Acknowledgement Receipt will establish the filing date of the application.

National Stage of an International Application under 35 U.S.C. 371

If a timely submission to enter the national stage of an international application is compliant with the conditions of 35 U.S.C. 371 and other applicable requirements a Form PCT/DO/EO/903 indicating acceptance of the application as a national stage submission under 35 U.S.C. 371 will be issued in addition to the Filing Receipt, in due course.

New International Application Filed with the USPTO as a Receiving Office

If a new international application is being filed and the international application includes the necessary components for an international filing date (see PCT Article 11 and MPEP 1810), a Notification of the International Application Number and of the International Filing Date (Form PCT/RO/105) will be issued in due course, subject to prescriptions concerning national security, and the date shown on this Acknowledgement Receipt will establish the international filing date of the application.

Electronic Acknowledgement Receipt

EFS ID:	23771678
Application Number:	29542318
International Application Number:	
Confirmation Number:	7943
Title of Invention:	Shoe Midsole
First Named Inventor/Applicant Name:	Jack Boys
Customer Number:	21888
Filer:	Alan Norman/Laurie Poss
Filer Authorized By:	Alan Norman
Attorney Docket Number:	56503-149126
Receipt Date:	13-OCT-2015
Filing Date:	
Time Stamp:	17:06:36
Application Type:	Design

Payment information:

Submitted with Payment	yes
Payment Type	Deposit Account
Payment was successfully received in RAM	\$900
RAM confirmation Number	4454
Deposit Account	200823
Authorized User	NORMAN, ALAN H

The Director of the USPTO is hereby authorized to charge indicated fees and credit any overpayment as follows:

Charge any Additional Fees required under 37 C.F.R. Section 1.16 (National application filing, search, and examination fees)

Charge any Additional Fees required under 37 C.F.R. Section 1.17 (Patent application and reexamination processing fees)

Charge any Additional Fees required under 37 C.F.R. Section 1.21 (Miscellaneous fees and charges)

File Listing:

Document Number	Document Description	File Name	File Size(Bytes)/ Message Digest	Multi Part /.zip	Pages (if appl.)
1	Application Data Sheet	ADS.pdf	1819130	no	7
			e3b01ee4858c620ef2290459e3bdfd070ae15f5b		
Warnings:					
Information:					
2	Specification	Specification-149126.pdf	63417	no	1
			4fb283ea9a4ff5b767633180a17ae14979508ec7		
Warnings:					
Information:					
3	Drawings-only black and white line drawings	56503-149126Drawings.pdf	4059959	no	6
			198bbb87a6f5df044333e9438a0e4a8a60780d8		
Warnings:					
The page size in the PDF is too large. The pages should be 8.5 x 11 or A4. If this PDF is submitted, the pages will be resized upon entry into the Image File Wrapper and may affect subsequent processing					
Information:					
4	Fee Worksheet (SB06)	fee-info.pdf	36246	no	2
			16d1093b7e03024c775a3fe2745fa43709c4e0fe		
Warnings:					
Information:					
Total Files Size (in bytes):			5978752		

This Acknowledgement Receipt evidences receipt on the noted date by the USPTO of the indicated documents, characterized by the applicant, and including page counts, where applicable. It serves as evidence of receipt similar to a Post Card, as described in MPEP 503.

New Applications Under 35 U.S.C. 111

If a new application is being filed and the application includes the necessary components for a filing date (see 37 CFR 1.53(b)-(d) and MPEP 506), a Filing Receipt (37 CFR 1.54) will be issued in due course and the date shown on this Acknowledgement Receipt will establish the filing date of the application.

National Stage of an International Application under 35 U.S.C. 371

If a timely submission to enter the national stage of an international application is compliant with the conditions of 35 U.S.C. 371 and other applicable requirements a Form PCT/DO/EO/903 indicating acceptance of the application as a national stage submission under 35 U.S.C. 371 will be issued in addition to the Filing Receipt, in due course.

New International Application Filed with the USPTO as a Receiving Office

If a new international application is being filed and the international application includes the necessary components for an international filing date (see PCT Article 11 and MPEP 1810), a Notification of the International Application Number and of the International Filing Date (Form PCT/RO/105) will be issued in due course, subject to prescriptions concerning national security, and the date shown on this Acknowledgement Receipt will establish the international filing date of the application.

SCORE Placeholder Sheet for IFW Content

Application Number: 29542318

Document Date: 10/13/2015

The presence of this form in the IFW record indicates that the following document type was received in electronic format on the date identified above. This content is stored in the SCORE database.

Since this was an electronic submission, there is no physical artifact folder, no artifact folder is recorded in PALM, and no paper documents or physical media exist. The TIFF images in the IFW record were created from the original documents that are stored in SCORE.

- Drawing

At the time of document entry (noted above):

- USPTO employees may access SCORE content via eDAN using the Supplemental Content tab, or via the SCORE web page.
- External customers may access SCORE content via PAIR using the Supplemental Content tab.



UNITED STATES PATENT AND TRADEMARK OFFICE

UNITED STATES DEPARTMENT OF COMMERCE
United States Patent and Trademark Office
Address: COMMISSIONER FOR PATENTS
P.O. Box 1450
Alexandria, Virginia 22313-1450
www.uspto.gov

Table with 7 columns: APPLICATION NUMBER, FILING or 371(c) DATE, GRP ART UNIT, FIL FEE REC'D, ATTY. DOCKET NO, TOT CLAIMS, IND CLAIMS. Row 1: 29/542,318, 10/13/2015, 2913, 900, 56503-149126, 1, 1

CONFIRMATION NO. 7943

FILING RECEIPT

21888
THOMPSON COBURN LLP
ONE US BANK PLAZA
SUITE 3500
ST LOUIS, MO 63101



Date Mailed: 10/16/2015

Receipt is acknowledged of this non-provisional patent application. The application will be taken up for examination in due course. Applicant will be notified as to the results of the examination. Any correspondence concerning the application must include the following identification information: the U.S. APPLICATION NUMBER, FILING DATE, NAME OF APPLICANT, and TITLE OF INVENTION. Fees transmitted by check or draft are subject to collection. Please verify the accuracy of the data presented on this receipt. If an error is noted on this Filing Receipt, please submit a written request for a Filing Receipt Correction. Please provide a copy of this Filing Receipt with the changes noted thereon. If you received a "Notice to File Missing Parts" for this application, please submit any corrections to this Filing Receipt with your reply to the Notice. When the USPTO processes the reply to the Notice, the USPTO will generate another Filing Receipt incorporating the requested corrections

Inventor(s) Jack Boys, Greenland, NH;
Applicant(s) Cole Haan LLC, New York, NY

Power of Attorney: None

Domestic Applications for which benefit is claimed - None.

A proper domestic benefit claim must be provided in an Application Data Sheet in order to constitute a claim for domestic benefit. See 37 CFR 1.76 and 1.78.

Foreign Applications for which priority is claimed (You may be eligible to benefit from the Patent Prosecution Highway program at the USPTO. Please see http://www.uspto.gov for more information.) - None.

Foreign application information must be provided in an Application Data Sheet in order to constitute a claim to foreign priority. See 37 CFR 1.55 and 1.76.

If Required, Foreign Filing License Granted: 10/15/2015

The country code and number of your priority application, to be used for filing abroad under the Paris Convention, is US 29/542,318

Projected Publication Date: None, application is not eligible for pre-grant publication

Non-Publication Request: No

Early Publication Request: No

Title

Shoe Midsole

Preliminary Class

D02

Statement under 37 CFR 1.55 or 1.78 for AIA (First Inventor to File) Transition Applications: No**PROTECTING YOUR INVENTION OUTSIDE THE UNITED STATES**

Since the rights granted by a U.S. patent extend only throughout the territory of the United States and have no effect in a foreign country, an inventor who wishes patent protection in another country must apply for a patent in a specific country or in regional patent offices. Applicants may wish to consider the filing of an international application under the Patent Cooperation Treaty (PCT). An international (PCT) application generally has the same effect as a regular national patent application in each PCT-member country. The PCT process **simplifies** the filing of patent applications on the same invention in member countries, but **does not result** in a grant of "an international patent" and does not eliminate the need of applicants to file additional documents and fees in countries where patent protection is desired.

Almost every country has its own patent law, and a person desiring a patent in a particular country must make an application for patent in that country in accordance with its particular laws. Since the laws of many countries differ in various respects from the patent law of the United States, applicants are advised to seek guidance from specific foreign countries to ensure that patent rights are not lost prematurely.

Applicants also are advised that in the case of inventions made in the United States, the Director of the USPTO must issue a license before applicants can apply for a patent in a foreign country. The filing of a U.S. patent application serves as a request for a foreign filing license. The application's filing receipt contains further information and guidance as to the status of applicant's license for foreign filing.

Applicants may wish to consult the USPTO booklet, "General Information Concerning Patents" (specifically, the section entitled "Treaties and Foreign Patents") for more information on timeframes and deadlines for filing foreign patent applications. The guide is available either by contacting the USPTO Contact Center at 800-786-9199, or it can be viewed on the USPTO website at <http://www.uspto.gov/web/offices/pac/doc/general/index.html>.

For information on preventing theft of your intellectual property (patents, trademarks and copyrights), you may wish to consult the U.S. Government website, <http://www.stopfakes.gov>. Part of a Department of Commerce initiative, this website includes self-help "toolkits" giving innovators guidance on how to protect intellectual property in specific countries such as China, Korea and Mexico. For questions regarding patent enforcement issues, applicants may call the U.S. Government hotline at 1-866-999-HALT (1-866-999-4258).

LICENSE FOR FOREIGN FILING UNDER
Title 35, United States Code, Section 184
Title 37, Code of Federal Regulations, 5.11 & 5.15

GRANTED

The applicant has been granted a license under 35 U.S.C. 184, if the phrase "IF REQUIRED, FOREIGN FILING LICENSE GRANTED" followed by a date appears on this form. Such licenses are issued in all applications where the conditions for issuance of a license have been met, regardless of whether or not a license may be required as set forth in 37 CFR 5.15. The scope and limitations of this license are set forth in 37 CFR 5.15(a) unless an earlier license has been issued under 37 CFR 5.15(b). The license is subject to revocation upon written notification. The date indicated is the effective date of the license, unless an earlier license of similar scope has been granted under 37 CFR 5.13 or 5.14.

This license is to be retained by the licensee and may be used at any time on or after the effective date thereof unless it is revoked. This license is automatically transferred to any related applications(s) filed under 37 CFR 1.53(d). This license is not retroactive.

The grant of a license does not in any way lessen the responsibility of a licensee for the security of the subject matter as imposed by any Government contract or the provisions of existing laws relating to espionage and the national security or the export of technical data. Licensees should apprise themselves of current regulations especially with respect to certain countries, of other agencies, particularly the Office of Defense Trade Controls, Department of State (with respect to Arms, Munitions and Implements of War (22 CFR 121-128)); the Bureau of Industry and Security, Department of Commerce (15 CFR parts 730-774); the Office of Foreign Assets Control, Department of Treasury (31 CFR Parts 500+) and the Department of Energy.

NOT GRANTED

No license under 35 U.S.C. 184 has been granted at this time, if the phrase "IF REQUIRED, FOREIGN FILING LICENSE GRANTED" DOES NOT appear on this form. Applicant may still petition for a license under 37 CFR 5.12, if a license is desired before the expiration of 6 months from the filing date of the application. If 6 months has lapsed from the filing date of this application and the licensee has not received any indication of a secrecy order under 35 U.S.C. 181, the licensee may foreign file the application pursuant to 37 CFR 5.15(b).

SelectUSA

The United States represents the largest, most dynamic marketplace in the world and is an unparalleled location for business investment, innovation, and commercialization of new technologies. The U.S. offers tremendous resources and advantages for those who invest and manufacture goods here. Through SelectUSA, our nation works to promote and facilitate business investment. SelectUSA provides information assistance to the international investor community; serves as an ombudsman for existing and potential investors; advocates on behalf of U.S. cities, states, and regions competing for global investment; and counsels U.S. economic development organizations on investment attraction best practices. To learn more about why the United States is the best country in the world to develop technology, manufacture products, deliver services, and grow your business, visit <http://www.SelectUSA.gov> or call +1-202-482-6800.



UNITED STATES PATENT AND TRADEMARK OFFICE

UNITED STATES DEPARTMENT OF COMMERCE
United States Patent and Trademark Office
Address: COMMISSIONER FOR PATENTS
P.O. Box 1450
Alexandria, Virginia 22313-1450
www.uspto.gov

APPLICATION NUMBER	FILING OR 371(C) DATE	FIRST NAMED APPLICANT	ATTY. DOCKET NO./TITLE
29/542,318	10/13/2015	Jack Boys	56503-149126

CONFIRMATION NO. 7943

INFORMAL NOTICE



21888
THOMPSON COBURN LLP
ONE US BANK PLAZA
SUITE 3500
ST LOUIS, MO 63101

Date Mailed: 10/16/2015

INFORMATIONAL NOTICE TO APPLICANT

Applicant is notified that the above-identified application contains the deficiencies noted below. No period for reply is set forth in this notice for correction of these deficiencies. However, if a deficiency relates to the inventor's oath or declaration, the applicant must file an oath or declaration in compliance with 37 CFR 1.63, or a substitute statement in compliance with 37 CFR 1.64, executed by or with respect to each actual inventor no later than the expiration of the time period set in the "Notice of Allowability" to avoid abandonment. See 37 CFR 1.53(f).

The item(s) indicated below are also required and should be submitted with any reply to this notice to avoid further processing delays.

- A properly executed inventor's oath or declaration has not been received for the following inventor(s):
Jack Boys

Questions about the contents of this notice and the requirements it sets forth should be directed to the Office of Data Management, Application Assistance Unit, at (571) 272-4000 or (571) 272-4200 or 1-888-786-0101.

/khoang/

Under the Paperwork Reduction ACT of 1995, no persons are required to respond to collection of information unless it displays a valid OMB control number.

**REQUEST FOR EXPEDITED
EXAMINATION OF A DESIGN
APPLICATION (37 CFR 1.155)**

Application Number	29/542,318
Filing Date	October 13, 2015
First Named Inventor	Jack Boys
Title	Shoe Midsole
Atty Docket Number	56503-149126

ADDRESS TO:

**MAIL STOP EXPEDITED DESIGN
COMMISSIONER FOR PATENTS
P.O. Box 1450
Alexandria, VA 22313-1450**

This is a request for expedited examination of a design application under 37 CFR 1.155.

NOTE: If the Request made by this form accompanies original application papers, include form PTO/SB/18 "Design Patent Application Transmittal" or its equivalent.

A preexamination search was conducted. The field of search was:

A search was conducted of the USPTO Patent Full-Text and Image Database, in which at least the following class and subclasses were partially searched: Class D02, Subclasses 946, 947, and 960.

Related applications: _____

If not previously filed for the above-identified application, the following items required by 37 CFR 1.155 are enclosed:

- Formal drawings (see 37 CFR 1.84).
- The fee set forth in 37 CFR 1.17(k).
- An information disclosure statement in compliance with 37 CFR 1.98.

/Alan H. Norman/

11/04/2015

Signature

Date

Alan H. Norman

32285

Typed or printed name

Registration Number, if applicable

314-552-6000

Telephone Number

WARNING: Information on this form may become public. Credit card information should not be included on this form. Provide credit card information and authorization on PTO-2038.

This collection of information is required by 37 CFR 1.155. The information is required to obtain or retain a benefit by the public which is to file (and by the USPTO to process) an application. Confidentiality is governed by 35 U.S.C. 122 and 37 CFR 1.11 and 1.14. This collection is estimated to take 6 minutes to complete, including gathering, preparing, and submitting the completed application form to the USPTO. Time will vary depending upon the individual case. Any comments on the amount of time you require to complete this form and/or suggestions for reducing this burden, should be sent to the Chief Information Officer, U.S. Patent and Trademark Office, U.S. Department of Commerce, P.O. Box 1450, Alexandria, VA 22313-1450. DO NOT SEND FEES OR COMPLETED FORMS TO THIS ADDRESS. **SEND TO: Commissioner for Patents, P.O. Box 1450, Alexandria, VA 22313-1450.**

If you need assistance in completing the form, call 1-800-PTO-9199 and select option 2.

Privacy Act Statement

The **Privacy Act of 1974 (P.L. 93-579)** requires that you be given certain information in connection with your submission of the attached form related to a patent application or patent. Accordingly, pursuant to the requirements of the Act, please be advised that: (1) the general authority for the collection of this information is 35 U.S.C. 2(b)(2); (2) furnishing of the information solicited is voluntary; and (3) the principal purpose for which the information is used by the U.S. Patent and Trademark Office is to process and/or examine your submission related to a patent application or patent. If you do not furnish the requested information, the U.S. Patent and Trademark Office may not be able to process and/or examine your submission, which may result in termination of proceedings or abandonment of the application or expiration of the patent.

The information provided by you in this form will be subject to the following routine uses:

1. The information on this form will be treated confidentially to the extent allowed under the Freedom of Information Act (5 U.S.C. 552) and the Privacy Act (5 U.S.C. 552a). Records from this system of records may be disclosed to the Department of Justice to determine whether disclosure of these records is required by the Freedom of Information Act.
2. A record from this system of records may be disclosed, as a routine use, in the course of presenting evidence to a court, magistrate, or administrative tribunal, including disclosures to opposing counsel in the course of settlement negotiations.
3. A record in this system of records may be disclosed, as a routine use, to a Member of Congress submitting a request involving an individual, to whom the record pertains, when the individual has requested assistance from the Member with respect to the subject matter of the record.
4. A record in this system of records may be disclosed, as a routine use, to a contractor of the Agency having need for the information in order to perform a contract. Recipients of information shall be required to comply with the requirements of the Privacy Act of 1974, as amended, pursuant to 5 U.S.C. 552a(m).
5. A record related to an International Application filed under the Patent Cooperation Treaty in this system of records may be disclosed, as a routine use, to the International Bureau of the World Intellectual Property Organization, pursuant to the Patent Cooperation Treaty.
6. A record in this system of records may be disclosed, as a routine use, to another federal agency for purposes of National Security review (35 U.S.C. 181) and for review pursuant to the Atomic Energy Act (42 U.S.C. 218(c)).
7. A record from this system of records may be disclosed, as a routine use, to the Administrator, General Services, or his/her designee, during an inspection of records conducted by GSA as part of that agency's responsibility to recommend improvements in records management practices and programs, under authority of 44 U.S.C. 2904 and 2906. Such disclosure shall be made in accordance with the GSA regulations governing inspection of records for this purpose, and any other relevant (*i.e.*, GSA or Commerce) directive. Such disclosure shall not be used to make determinations about individuals.
8. A record from this system of records may be disclosed, as a routine use, to the public after either publication of the application pursuant to 35 U.S.C. 122(b) or issuance of a patent pursuant to 35 U.S.C. 151. Further, a record may be disclosed, subject to the limitations of 37 CFR 1.14, as a routine use, to the public if the record was filed in an application which became abandoned or in which the proceedings were terminated and which application is referenced by either a published application, an application open to public inspection or an issued patent.
9. A record from this system of records may be disclosed, as a routine use, to a Federal, State, or local law enforcement agency, if the USPTO becomes aware of a violation or potential violation of law or regulation.

INFORMATION DISCLOSURE STATEMENT BY APPLICANT (Not for submission under 37 CFR 1.99)	Application Number		29542318
	Filing Date		2015-10-13
	First Named Inventor	Jack Boys	
	Art Unit		2913
	Examiner Name	Not Yet Assigned	
	Attorney Docket Number		56503-149126

U.S.PATENTS						Remove
Examiner Initial*	Cite No	Patent Number	Kind Code ¹	Issue Date	Name of Patentee or Applicant of cited Document	Pages,Columns,Lines where Relevant Passages or Relevant Figures Appear
	1	4680877		1987-07-21	Fink	
	2	7941938		2011-05-17	Yu et al.	
	3	D398743	S	1998-09-29	Rask	
	4	D430723		2000-09-12	Kim	
	5	D498901		2004-11-30	Hawker et al.	
	6	D509049		2005-09-06	McClaskie	
	7	D623835		2010-09-21	Tzenos	
	8	D634108		2011-03-15	Tzenos	

**INFORMATION DISCLOSURE
STATEMENT BY APPLICANT**
(Not for submission under 37 CFR 1.99)

Application Number	29542318
Filing Date	2015-10-13
First Named Inventor	Jack Boys
Art Unit	2913
Examiner Name	Not Yet Assigned
Attorney Docket Number	56503-149126

9	D671306		2012-11-27	Tzenos	
10	D671723		2012-12-04	Teteriatnikov	
11	D672123	S	2012-12-11	Williams, Jr.	
12	D685567	S	2013-07-09	Dolce	
13	D690088	S	2013-09-24	Hardman	
14	D713626	S	2014-09-23	Raasch	

If you wish to add additional U.S. Patent citation information please click the Add button. Add

U.S.PATENT APPLICATION PUBLICATIONS

Remove

Examiner Initial*	Cite No	Publication Number	Kind Code ¹	Publication Date	Name of Patentee or Applicant of cited Document	Pages,Columns,Lines where Relevant Passages or Relevant Figures Appear
	1	20140150298	A1	2014-06-05	Crowley et al.	

If you wish to add additional U.S. Published Application citation information please click the Add button. Add

FOREIGN PATENT DOCUMENTS

Remove

Examiner Initial*	Cite No	Foreign Document Number ³	Country Code ² j	Kind Code ⁴	Publication Date	Name of Patentee or Applicant of cited Document	Pages,Columns,Lines where Relevant Passages or Relevant Figures Appear	T ⁵

INFORMATION DISCLOSURE STATEMENT BY APPLICANT (Not for submission under 37 CFR 1.99)	Application Number	29542318
	Filing Date	2015-10-13
	First Named Inventor	Jack Boys
	Art Unit	2913
	Examiner Name	Not Yet Assigned
	Attorney Docket Number	56503-149126

	1								<input type="checkbox"/>
--	---	--	--	--	--	--	--	--	--------------------------

If you wish to add additional Foreign Patent Document citation information please click the Add button **Add**

NON-PATENT LITERATURE DOCUMENTS

Remove

Examiner Initials*	Cite No	Include name of the author (in CAPITAL LETTERS), title of the article (when appropriate), title of the item (book, magazine, journal, serial, symposium, catalog, etc), date, pages(s), volume-issue number(s), publisher, city and/or country where published.	T ⁵
	1		<input type="checkbox"/>

If you wish to add additional non-patent literature document citation information please click the Add button **Add**

EXAMINER SIGNATURE

Examiner Signature		Date Considered	
--------------------	--	-----------------	--

*EXAMINER: Initial if reference considered, whether or not citation is in conformance with MPEP 609. Draw line through a citation if not in conformance and not considered. Include copy of this form with next communication to applicant.

¹ See Kind Codes of USPTO Patent Documents at www.USPTO.GOV or MPEP 901.04. ² Enter office that issued the document, by the two-letter code (WIPO Standard ST.3). ³ For Japanese patent documents, the indication of the year of the reign of the Emperor must precede the serial number of the patent document. ⁴ Kind of document by the appropriate symbols as indicated on the document under WIPO Standard ST.16 if possible. ⁵ Applicant is to place a check mark here if English language translation is attached.

INFORMATION DISCLOSURE STATEMENT BY APPLICANT (Not for submission under 37 CFR 1.99)	Application Number	29542318
	Filing Date	2015-10-13
	First Named Inventor	Jack Boys
	Art Unit	2913
	Examiner Name	Not Yet Assigned
	Attorney Docket Number	56503-149126

CERTIFICATION STATEMENT

Please see 37 CFR 1.97 and 1.98 to make the appropriate selection(s):

That each item of information contained in the information disclosure statement was first cited in any communication from a foreign patent office in a counterpart foreign application not more than three months prior to the filing of the information disclosure statement. See 37 CFR 1.97(e)(1).

OR

That no item of information contained in the information disclosure statement was cited in a communication from a foreign patent office in a counterpart foreign application, and, to the knowledge of the person signing the certification after making reasonable inquiry, no item of information contained in the information disclosure statement was known to any individual designated in 37 CFR 1.56(c) more than three months prior to the filing of the information disclosure statement. See 37 CFR 1.97(e)(2).

See attached certification statement.

The fee set forth in 37 CFR 1.17 (p) has been submitted herewith.

A certification statement is not submitted herewith.

SIGNATURE

A signature of the applicant or representative is required in accordance with CFR 1.33, 10.18. Please see CFR 1.4(d) for the form of the signature.

Signature	/Alan H. Norman/	Date (YYYY-MM-DD)	2015-11-04
Name/Print	Alan H. Norman	Registration Number	32285

This collection of information is required by 37 CFR 1.97 and 1.98. The information is required to obtain or retain a benefit by the public which is to file (and by the USPTO to process) an application. Confidentiality is governed by 35 U.S.C. 122 and 37 CFR 1.14. This collection is estimated to take 1 hour to complete, including gathering, preparing and submitting the completed application form to the USPTO. Time will vary depending upon the individual case. Any comments on the amount of time you require to complete this form and/or suggestions for reducing this burden, should be sent to the Chief Information Officer, U.S. Patent and Trademark Office, U.S. Department of Commerce, P.O. Box 1450, Alexandria, VA 22313-1450. **DO NOT SEND FEES OR COMPLETED FORMS TO THIS ADDRESS. SEND TO: Commissioner for Patents, P.O. Box 1450, Alexandria, VA 22313-1450.**

Privacy Act Statement

The Privacy Act of 1974 (P.L. 93-579) requires that you be given certain information in connection with your submission of the attached form related to a patent application or patent. Accordingly, pursuant to the requirements of the Act, please be advised that: (1) the general authority for the collection of this information is 35 U.S.C. 2(b)(2); (2) furnishing of the information solicited is voluntary; and (3) the principal purpose for which the information is used by the U.S. Patent and Trademark Office is to process and/or examine your submission related to a patent application or patent. If you do not furnish the requested information, the U.S. Patent and Trademark Office may not be able to process and/or examine your submission, which may result in termination of proceedings or abandonment of the application or expiration of the patent.

The information provided by you in this form will be subject to the following routine uses:

1. The information on this form will be treated confidentially to the extent allowed under the Freedom of Information Act (5 U.S.C. 552) and the Privacy Act (5 U.S.C. 552a). Records from this system of records may be disclosed to the Department of Justice to determine whether the Freedom of Information Act requires disclosure of these records.
2. A record from this system of records may be disclosed, as a routine use, in the course of presenting evidence to a court, magistrate, or administrative tribunal, including disclosures to opposing counsel in the course of settlement negotiations.
3. A record in this system of records may be disclosed, as a routine use, to a Member of Congress submitting a request involving an individual, to whom the record pertains, when the individual has requested assistance from the Member with respect to the subject matter of the record.
4. A record in this system of records may be disclosed, as a routine use, to a contractor of the Agency having need for the information in order to perform a contract. Recipients of information shall be required to comply with the requirements of the Privacy Act of 1974, as amended, pursuant to 5 U.S.C. 552a(m).
5. A record related to an International Application filed under the Patent Cooperation Treaty in this system of records may be disclosed, as a routine use, to the International Bureau of the World Intellectual Property Organization, pursuant to the Patent Cooperation Treaty.
6. A record in this system of records may be disclosed, as a routine use, to another federal agency for purposes of National Security review (35 U.S.C. 181) and for review pursuant to the Atomic Energy Act (42 U.S.C. 218(c)).
7. A record from this system of records may be disclosed, as a routine use, to the Administrator, General Services, or his/her designee, during an inspection of records conducted by GSA as part of that agency's responsibility to recommend improvements in records management practices and programs, under authority of 44 U.S.C. 2904 and 2906. Such disclosure shall be made in accordance with the GSA regulations governing inspection of records for this purpose, and any other relevant (i.e., GSA or Commerce) directive. Such disclosure shall not be used to make determinations about individuals.
8. A record from this system of records may be disclosed, as a routine use, to the public after either publication of the application pursuant to 35 U.S.C. 122(b) or issuance of a patent pursuant to 35 U.S.C. 151. Further, a record may be disclosed, subject to the limitations of 37 CFR 1.14, as a routine use, to the public if the record was filed in an application which became abandoned or in which the proceedings were terminated and which application is referenced by either a published application, an application open to public inspections or an issued patent.
9. A record from this system of records may be disclosed, as a routine use, to a Federal, State, or local law enforcement agency, if the USPTO becomes aware of a violation or potential violation of law or regulation.

Electronic Patent Application Fee Transmittal

Application Number:	29542318
Filing Date:	13-Oct-2015
Title of Invention:	Shoe Midsole
First Named Inventor/Applicant Name:	Jack Boys
Filer:	Alan Norman/Kristen Godar
Attorney Docket Number:	56503-149126

Filed as Large Entity

Filing Fees for Design

Description	Fee Code	Quantity	Amount	Sub-Total in USD(\$)
Basic Filing:				
Pages:				
Claims:				
Miscellaneous-Filing:				
Petition:				
Patent-Appeals-and-Interference:				
Post-Allowance-and-Post-Issuance:				
Extension-of-Time:				

Description	Fee Code	Quantity	Amount	Sub-Total in USD(\$)
Miscellaneous:				
Request Expedited Exam of Design Appl	1802	1	900	900
Total in USD (\$)				900

Electronic Acknowledgement Receipt

EFS ID:	23986809
Application Number:	29542318
International Application Number:	
Confirmation Number:	7943
Title of Invention:	Shoe Midsole
First Named Inventor/Applicant Name:	Jack Boys
Customer Number:	21888
Filer:	Alan Norman/Kristen Godar
Filer Authorized By:	Alan Norman
Attorney Docket Number:	56503-149126
Receipt Date:	04-NOV-2015
Filing Date:	13-OCT-2015
Time Stamp:	15:27:09
Application Type:	Design

Payment information:

Submitted with Payment	yes
Payment Type	Deposit Account
Payment was successfully received in RAM	\$900
RAM confirmation Number	1839
Deposit Account	200823
Authorized User	NORMAN, ALAN H

The Director of the USPTO is hereby authorized to charge indicated fees and credit any overpayment as follows:

Charge any Additional Fees required under 37 C.F.R. Section 1.17 (Patent application and reexamination processing fees)

Charge any Additional Fees required under 37 C.F.R. Section 1.21 (Miscellaneous fees and charges)

File Listing:

Document Number	Document Description	File Name	File Size(Bytes)/ Message Digest	Multi Part /.zip	Pages (if appl.)
1	Req for Expedited Processing, Design Rocket Docket	Request.pdf	218690	no	2
			b57121a7473d698d0e55ce30a15b25c0fcc97fce		
Warnings:					
Information:					
2	Information Disclosure Statement (IDS) Form (SB08)	IDS.pdf	1035403	no	5
			be7fd01bc3c53d86671136aae32b8c63822c02a5		
Warnings:					
Information:					
3	Fee Worksheet (SB06)	fee-info.pdf	30310	no	2
			fcab7e0b1e47aeea34ed3667a12306f667cd801		
Warnings:					
Information:					
Total Files Size (in bytes):			1284403		

This Acknowledgement Receipt evidences receipt on the noted date by the USPTO of the indicated documents, characterized by the applicant, and including page counts, where applicable. It serves as evidence of receipt similar to a Post Card, as described in MPEP 503.

New Applications Under 35 U.S.C. 111

If a new application is being filed and the application includes the necessary components for a filing date (see 37 CFR 1.53(b)-(d) and MPEP 506), a Filing Receipt (37 CFR 1.54) will be issued in due course and the date shown on this Acknowledgement Receipt will establish the filing date of the application.

National Stage of an International Application under 35 U.S.C. 371

If a timely submission to enter the national stage of an international application is compliant with the conditions of 35 U.S.C. 371 and other applicable requirements a Form PCT/DO/EO/903 indicating acceptance of the application as a national stage submission under 35 U.S.C. 371 will be issued in addition to the Filing Receipt, in due course.

New International Application Filed with the USPTO as a Receiving Office

If a new international application is being filed and the international application includes the necessary components for an international filing date (see PCT Article 11 and MPEP 1810), a Notification of the International Application Number and of the International Filing Date (Form PCT/RO/105) will be issued in due course, subject to prescriptions concerning national security, and the date shown on this Acknowledgement Receipt will establish the international filing date of the application.



UNITED STATES PATENT AND TRADEMARK OFFICE

UNITED STATES DEPARTMENT OF COMMERCE
United States Patent and Trademark Office
Address: COMMISSIONER FOR PATENTS
P.O. Box 1450
Alexandria, Virginia 22313-1450
www.uspto.gov

APPLICATION NO.	FILING DATE	FIRST NAMED INVENTOR	ATTORNEY DOCKET NO.	CONFIRMATION NO.
29/542,318	10/13/2015	Jack Boys	56503-149126	7943
21888	7590	11/20/2015	EXAMINER	
THOMPSON COBURN LLP			HATTAN, SUSAN B	
ONE US BANK PLAZA			ART UNIT	PAPER NUMBER
SUITE 3500			2918	
ST LOUIS, MO 63101			NOTIFICATION DATE	DELIVERY MODE
			11/20/2015	ELECTRONIC

Please find below and/or attached an Office communication concerning this application or proceeding.

The time period for reply, if any, is set in the attached communication.

Notice of the Office communication was sent electronically on above-indicated "Notification Date" to the following e-mail address(es):

IPDOCKET@THOMPSONCOBURN.COM

Under the Paperwork Reduction ACT of 1995, no persons are required to respond to collection of information unless it displays a valid OMB control number.

REQUEST FOR EXPEDITED EXAMINATION OF A DESIGN APPLICATION (37 CFR 1.155)	Application Number	29/542,318
	Filing Date	October 13, 2015
	First Named Inventor	Jack Boys
	Title	Shoe Midsole
	Atty Docket Number	56503-149126

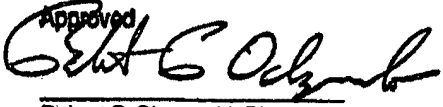
<p>ADDRESS TO:</p> <p>MAIL STOP EXPEDITED DESIGN COMMISSIONER FOR PATENTS P.O. Box 1450 Alexandria, VA 22313-1450</p>	<p>Approved</p>  Robert P. Olszewski, Director Technology Center 2800
--	---

This is a request for expedited examination of a design application under 37 CFR 1.155.

NOTE: If the Request made by this form accompanies original application papers, include form PTO/SB/18 "Design Patent Application Transmittal" or its equivalent.

A preexamination search was conducted. The field of search was:
 A search was conducted of the USPTO Patent Full-Text and Image Database, in which at least the following class and subclasses were partially searched: Class D02, Subclasses 946, 947, and 960.

Related applications: _____

If not previously filed for the above-identified application, the following items required by 37 CFR 1.155 are enclosed:

- Formal drawings (see 37 CFR 1.84).
- The fee set forth in 37 CFR 1.17(k).
- An information disclosure statement in compliance with 37 CFR 1.98.

_____ /Alan H. Norman/ _____ Signature	_____ 11/04/2015 _____ Date
_____ Alan H. Norman _____ Typed or printed name	_____ 32285 _____ Registration Number, if applicable
_____ 314-552-6000 _____ Telephone Number	

WARNING: Information on this form may become public. Credit card information should not be included on this form. Provide credit card information and authorization on PTO-2038.

This collection of information is required by 37 CFR 1.155. The information is required to obtain or retain a benefit by the public which is to file (and by the USPTO to process) an application. Confidentiality is governed by 35 U.S.C. 122 and 37 CFR 1.11 and 1.14. This collection is estimated to take 6 minutes to complete, including gathering, preparing, and submitting the completed application form to the USPTO. Time will vary depending upon the individual case. Any comments on the amount of time you require to complete this form and/or suggestions for reducing this burden, should be sent to the Chief Information Officer, U.S. Patent and Trademark Office, U.S. Department of Commerce, P.O. Box 1450, Alexandria, VA 22313-1450. DO NOT SEND FEES OR COMPLETED FORMS TO THIS ADDRESS. SEND TO: Commissioner for Patents, P.O. Box 1450, Alexandria, VA 22313-1450.

If you need assistance in completing the form, call 1-800-PTO-9199 and select option 2.

Under the Paperwork Reduction Act of 1995, no persons are required to respond to a collection of information unless it displays a valid OMB control number.

TRANSMITTAL FOR POWER OF ATTORNEY TO ONE OR MORE REGISTERED PRACTITIONERS

NOTE: This form is to be submitted with the Power of Attorney by Applicant form (PTO/AIA/82B) to identify the application to which the Power of Attorney is directed, in accordance with 37 CFR 1.5, unless the application number and filing date are identified in the Power of Attorney by Applicant form. If neither form PTO/AIA/82A nor form PTO/AIA82B identifies the application to which the Power of Attorney is directed, the Power of Attorney will not be recognized in the application.

Application Number	29/542,318
Filing Date	October 13, 2015
First Named Inventor	Jack Boys
Title	Shoe Midsole
Art Unit	not yet assigned
Examiner Name	not yet assigned
Attorney Docket Number	56503-149126

SIGNATURE of Applicant or Patent Practitioner			
Signature	/alan h. norman/	Date (Optional)	
Name	Alan H. Norman	Registration Number	32285
Title (if Applicant is a juristic entity)			
Applicant Name (if Applicant is a juristic entity)			
<p>NOTE: This form must be signed in accordance with 37 CFR 1.33. See 37 CFR 1.4(d) for signature requirements and certifications. If more than one applicant, use multiple forms.</p>			
<p><input type="checkbox"/> *Total of _____ forms are submitted.</p>			

This collection of information is required by 37 CFR 1.131, 1.32, and 1.33. The information is required to obtain or retain a benefit by the public which is to file (and by the USPTO to process) an application. Confidentiality is governed by 35 U.S.C. 122 and 37 CFR 1.11 and 1.14. This collection is estimated to take 3 minutes to complete, including gathering, preparing, and submitting the completed application form to the USPTO. Time will vary depending upon the individual case. Any comments on the amount of time you require to complete this form and/or suggestions for reducing this burden, should be sent to the Chief Information Officer, U.S. Patent and Trademark Office, U.S. Department of Commerce, P.O. Box 1450, Alexandria, VA 22313-1450. DO NOT SEND FEES OR COMPLETED FORMS TO THIS ADDRESS. **SEND TO: Commissioner for Patents, P.O. Box 1450, Alexandria, VA 22313-1450.**

If you need assistance in completing the form, call 1-800-PTO-9199 and select option 2.

Under the Paperwork Reduction Act of 1995, no persons are required to respond to a collection of information unless it displays a valid OMB control number

POWER OF ATTORNEY BY APPLICANT

I hereby revoke all previous powers of attorney given in the application identified in either the attached transmittal letter or the boxes below.

Application Number	Filing Date

(Note: The boxes above may be left blank if information is provided on form PTO/AIA/82A.)

- I hereby appoint the Patent Practitioner(s) associated with the following Customer Number as my/our attorney(s) or agent(s), and to transact all business in the United States Patent and Trademark Office connected therewith for the application referenced in the attached transmittal letter (form PTO/AIA/82A) or identified above: 021888
- OR**
- I hereby appoint Practitioner(s) named in the attached list (form PTO/AIA/82C) as my/our attorney(s) or agent(s), and to transact all business in the United States Patent and Trademark Office connected therewith for the patent application referenced in the attached transmittal letter (form PTO/AIA/82A) or identified above. (Note: Complete form PTO/AIA/82C.)

Please recognize or change the correspondence address for the application identified in the attached transmittal letter or the boxes above to:

- The address associated with the above-mentioned Customer Number
- OR**
- The address associated with Customer Number:
- OR**

Firm or Individual Name					
Address					
City		State		Zip	
Country					
Telephone		Email			

I am the Applicant (if the Applicant is a juristic entity, list the Applicant name in the box):

Cole Haan LLC

- Inventor or Joint Inventor (title not required below)
- Legal Representative of a Deceased or Legally Incapacitated Inventor (title not required below)
- Assignee or Person to Whom the Inventor is Under an Obligation to Assign (provide signer's title if applicant is a juristic entity)
- Person Who Otherwise Shows Sufficient Proprietary Interest (e.g., a petition under 37 CFR 1.46(b)(2) was granted in the application or is concurrently being filed with this document) (provide signer's title if applicant is a juristic entity)

SIGNATURE of Applicant for Patent

The undersigned (whose title is supplied below) is authorized to act on behalf of the applicant (e.g., where the applicant is a juristic entity).

Signature	<i>Laura Kelley</i>	Date (Optional)	
Name	<i>Laura Kelley</i>		
Title	<i>vLegal, HR & ©</i>		

NOTE: Signature - This form must be signed by the applicant in accordance with 37 CFR 1.33. See 37 CFR 1.4 for signature requirements and certifications. If more than one applicant, use multiple forms.

Total of _____ forms are submitted.

This collection of information is required by 37 CFR 1.131, 1.32, and 1.33. The information is required to obtain or retain a benefit by the public which is to file (and by the USPTO to process) an application. Confidentiality is governed by 35 U.S.C. 122 and 37 CFR 1.11 and 1.14. This collection is estimated to take 3 minutes to complete, including gathering, preparing, and submitting the completed application form to the USPTO. Time will vary depending upon the individual case. Any comments on the amount of time you require to complete this form and/or suggestions for reducing this burden, should be sent to the Chief Information Officer, U.S. Patent and Trademark Office, U.S. Department of Commerce, P.O. Box 1450, Alexandria, VA 22313-1450. DO NOT SEND FEES OR COMPLETED FORMS TO THIS ADDRESS. SEND TO: Commissioner for Patents, P.O. Box 1450, Alexandria, VA 22313-1450.

If you need assistance in completing the form, call 1-800-PTO-9199 and select option 2.

DECLARATION (37 CFR 1.63) FOR UTILITY OR DESIGN APPLICATION USING AN APPLICATION DATA SHEET (37 CFR 1.76)

Title of Invention

Shoe Midsole

As the below named inventor, I hereby declare that:

This declaration is directed to: The attached application, or
 United States application or PCT international application number 29/542,318
 filed on October 13, 2015

The above-identified application was made or authorized to be made by me.

I believe that I am the original inventor or an original joint inventor of a claimed invention in the application.

I hereby acknowledge that any willful false statement made in this declaration is punishable under 18 U.S.C. 1001 by fine or imprisonment of not more than five (5) years, or both.

I have reviewed and understand the subject matter of the above-identified application, including the claims.

I am aware of and acknowledge the duty to disclose to the United States Patent and Trademark Office all information known to me to be material to patentability as defined in 37 CFR 1.56, including for continuation-in-part applications material information which became available between the filing date of the prior application and the national or PCT International filing date of the continuation-in-part application.

WARNING:

Petitioner/applicant is cautioned to avoid submitting personal information in documents filed in a patent application that may contribute to identity theft. Personal information such as social security numbers, bank account numbers, or credit card numbers (other than a check or credit card authorization form PTO-2038 submitted for payment purposes) is never required by the USPTO to support a petition or an application. If this type of personal information is included in documents submitted to the USPTO, petitioners/applicants should consider redacting such personal information from the documents before submitting them to the USPTO. Petitioner/applicant is advised that the record of a patent application is available to the public after publication of the application (unless a non-publication request in compliance with 37 CFR 1.213(a) is made in the application) or issuance of a patent. Furthermore, the record from an abandoned application may also be available to the public if the application is referenced in a published application or an issued patent (see 37 CFR 1.14). Checks and credit card authorization forms PTO-2038 submitted for payment purposes are not retained in the application file and therefore are not publicly available.

LEGAL NAME OF INVENTOR

Inventor: Jack Boys Date (Optional): _____

Signature:  _____

THIS IS A MODIFIED VERSION OF U.S.P.T.O. FORM PTO/AIA/01.

Electronic Acknowledgement Receipt

EFS ID:	24166906
Application Number:	29542318
International Application Number:	
Confirmation Number:	7943
Title of Invention:	Shoe Midsole
First Named Inventor/Applicant Name:	Jack Boys
Customer Number:	21888
Filer:	Alan Norman/Laurie Poss
Filer Authorized By:	Alan Norman
Attorney Docket Number:	56503-149126
Receipt Date:	23-NOV-2015
Filing Date:	13-OCT-2015
Time Stamp:	16:57:29
Application Type:	Design

Payment information:

Submitted with Payment	no
------------------------	----

File Listing:

Document Number	Document Description	File Name	File Size(Bytes)/ Message Digest	Multi Part /.zip	Pages (if appl.)
1		Formals-149126.PDF	183110 <small>c1d105cadb1d362db4dad1ec5511d6fd619a6cb9</small>	yes	3

Multipart Description/PDF files in .zip description			
Document Description		Start	End
Power of Attorney		1	2
Oath or Declaration filed		3	3

Warnings:

Information:

Total Files Size (in bytes):	183110
-------------------------------------	--------

This Acknowledgement Receipt evidences receipt on the noted date by the USPTO of the indicated documents, characterized by the applicant, and including page counts, where applicable. It serves as evidence of receipt similar to a Post Card, as described in MPEP 503.

New Applications Under 35 U.S.C. 111

If a new application is being filed and the application includes the necessary components for a filing date (see 37 CFR 1.53(b)-(d) and MPEP 506), a Filing Receipt (37 CFR 1.54) will be issued in due course and the date shown on this Acknowledgement Receipt will establish the filing date of the application.

National Stage of an International Application under 35 U.S.C. 371

If a timely submission to enter the national stage of an international application is compliant with the conditions of 35 U.S.C. 371 and other applicable requirements a Form PCT/DO/EO/903 indicating acceptance of the application as a national stage submission under 35 U.S.C. 371 will be issued in addition to the Filing Receipt, in due course.

New International Application Filed with the USPTO as a Receiving Office

If a new international application is being filed and the international application includes the necessary components for an international filing date (see PCT Article 11 and MPEP 1810), a Notification of the International Application Number and of the International Filing Date (Form PCT/RO/105) will be issued in due course, subject to prescriptions concerning national security, and the date shown on this Acknowledgement Receipt will establish the international filing date of the application.



UNITED STATES PATENT AND TRADEMARK OFFICE

UNITED STATES DEPARTMENT OF COMMERCE
United States Patent and Trademark Office
Address: COMMISSIONER FOR PATENTS
P.O. Box 1450
Alexandria, Virginia 22313-1450
www.uspto.gov

APPLICATION NUMBER	FILING OR 371(C) DATE	FIRST NAMED APPLICANT	ATTY. DOCKET NO./TITLE
29/542,318	10/13/2015	Jack Boys	56503-149126

CONFIRMATION NO. 7943

POA ACCEPTANCE LETTER



21888
THOMPSON COBURN LLP
ONE US BANK PLAZA
SUITE 3500
ST LOUIS, MO 63101

Date Mailed: 12/04/2015

NOTICE OF ACCEPTANCE OF POWER OF ATTORNEY

This is in response to the Power of Attorney filed 11/23/2015.

The Power of Attorney in this application is accepted. Correspondence in this application will be mailed to the above address as provided by 37 CFR 1.33.

Questions about the contents of this notice and the requirements it sets forth should be directed to the Office of Data Management, Application Assistance Unit, at (571) 272-4000 or (571) 272-4200 or 1-888-786-0101.

/hachristian/



UNITED STATES PATENT AND TRADEMARK OFFICE

UNITED STATES DEPARTMENT OF COMMERCE
United States Patent and Trademark Office
Address: COMMISSIONER FOR PATENTS
P.O. Box 1450
Alexandria, Virginia 22313-1450
www.uspto.gov

Table with 5 columns: APPLICATION NO., FILING DATE, FIRST NAMED INVENTOR, ATTORNEY DOCKET NO., CONFIRMATION NO.
29/542,318 10/13/2015 Jack Boys 56503-149126 7943

21888 7590 03/01/2016
THOMPSON COBURN LLP
ONE US BANK PLAZA
SUITE 3500
ST LOUIS, MO 63101

EXAMINER

NELSON, THORNTON C

ART UNIT PAPER NUMBER

2914

NOTIFICATION DATE DELIVERY MODE

03/01/2016

ELECTRONIC

Please find below and/or attached an Office communication concerning this application or proceeding.

The time period for reply, if any, is set in the attached communication.

Notice of the Office communication was sent electronically on above-indicated "Notification Date" to the following e-mail address(es):

IPDOCKET@THOMPSONCOBURN.COM

Art Unit: 2914

Detailed action

The present application, filed on or after March 16, 2013, is being examined under the first inventor to file provisions of the AIA.

Rejection under 35 U.S.C. 112, first and second paragraphs

The claim is rejected under 35 U.S.C. 112(a) and (b) or 35 U.S.C. 112, first and second paragraphs, (pre-AIA) as the claimed invention is not described in such full, clear, concise and exact terms as to enable any person skilled in the art to make and use the same, and fails to particularly point out and distinctly claim the subject matter which applicant regards as the invention.

The claim is indefinite and nonenabling because the shape and appearance of the design is unclear due to inconsistencies between the drawing views that affect the understanding of what is claimed. Specifically, the following is noted:

-The Figure 2, 3, 5, and 6 views are inconsistent in the depiction of the structure of the toe area, as well as whether this portion of the design is claimed or not. Specifically, Figures 2 and 3 show that the front toe section of the midsole is claimed with shading and solid lines defining the structure. The Figure 6 view shows a broken line defining a boundary of the toe region as it curves up from the bottom of the sole, and the broken line perimeter and lack of shading indicate that this region is not part of the claim. Furthermore, Figures 2 and 3 each show a peak on either side of the center

Art Unit: 2914

of the toe, suggesting a bowl-shaped depression at the front center of the midsole toe. Finally, Figures 2 and 3 show that the claimed toe region should be visible from above in the Figure 5 view, but it is not shown; and similarly Figure 5 fails to show the side elements that extend beyond the upper perimeter (see below):

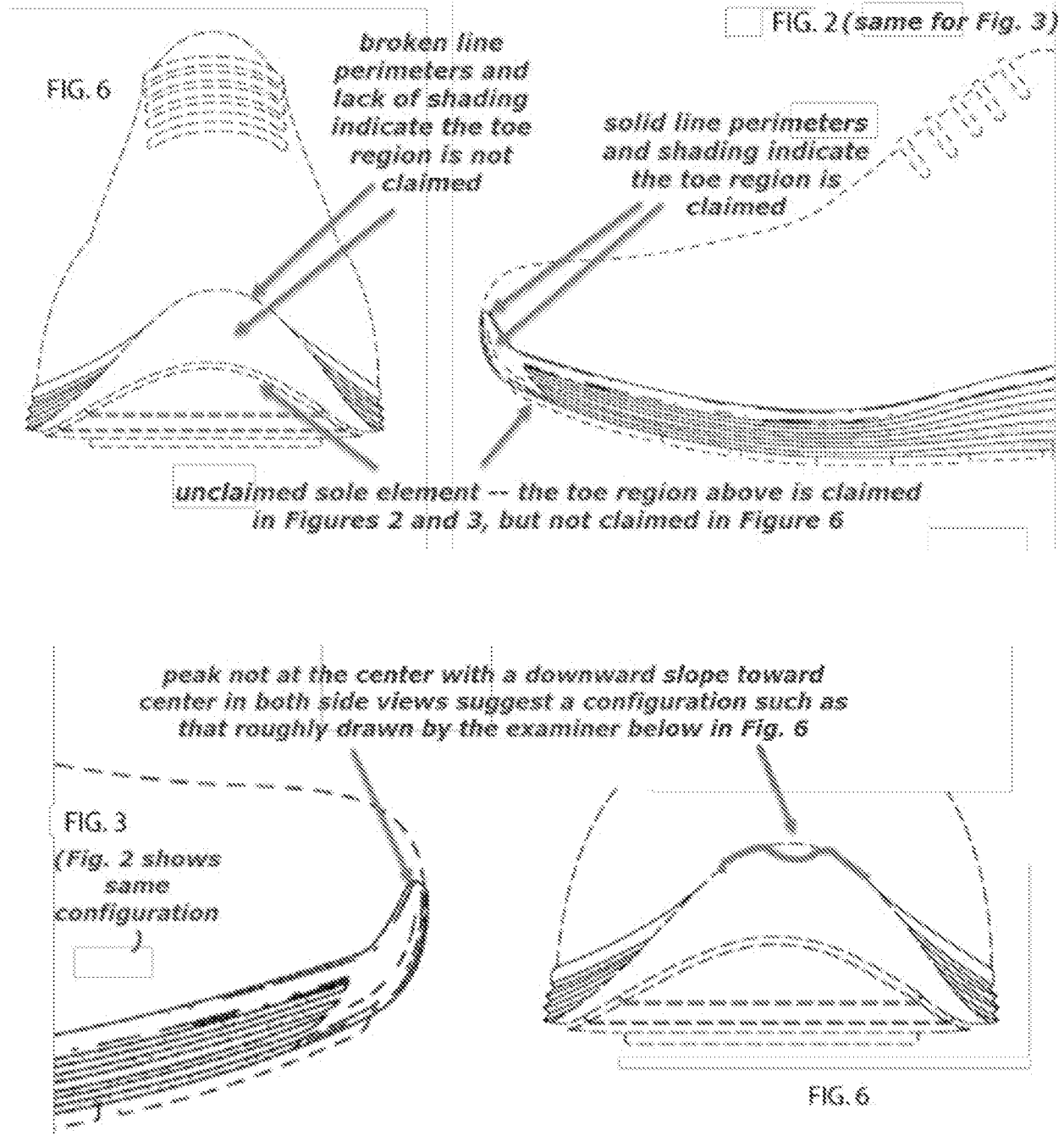

Art Unit: 2914

*most distant
point forward
being claimed
in Fig. 2/3
suggests that
it would be
seen from
above in Fig. 5*

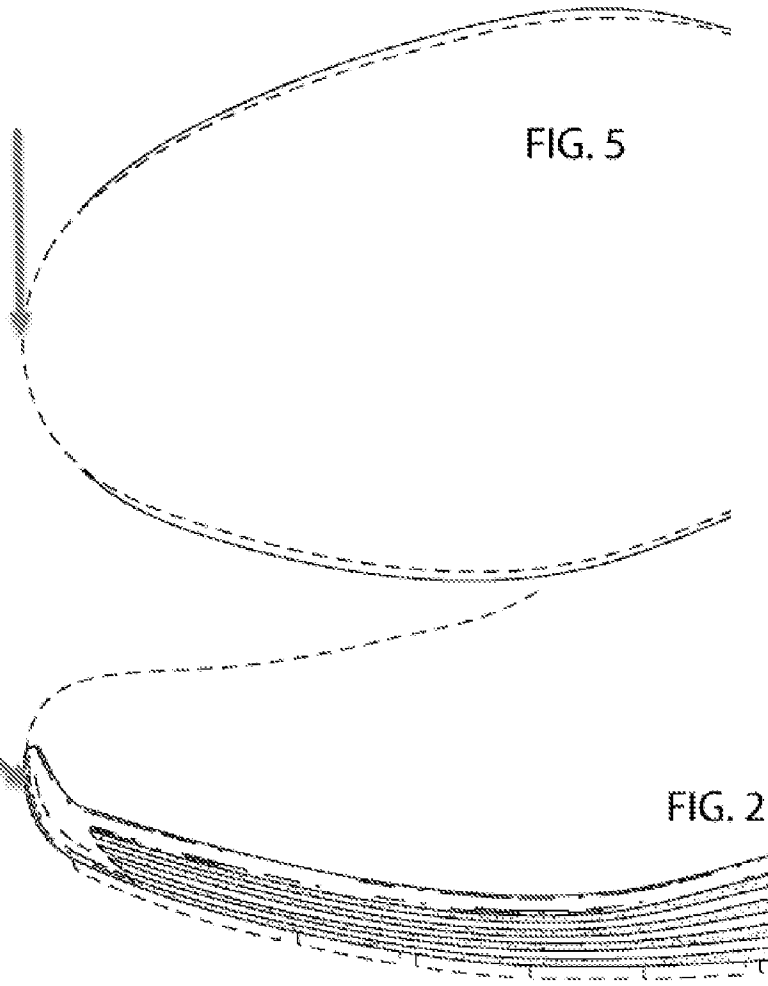

Art Unit: 2914

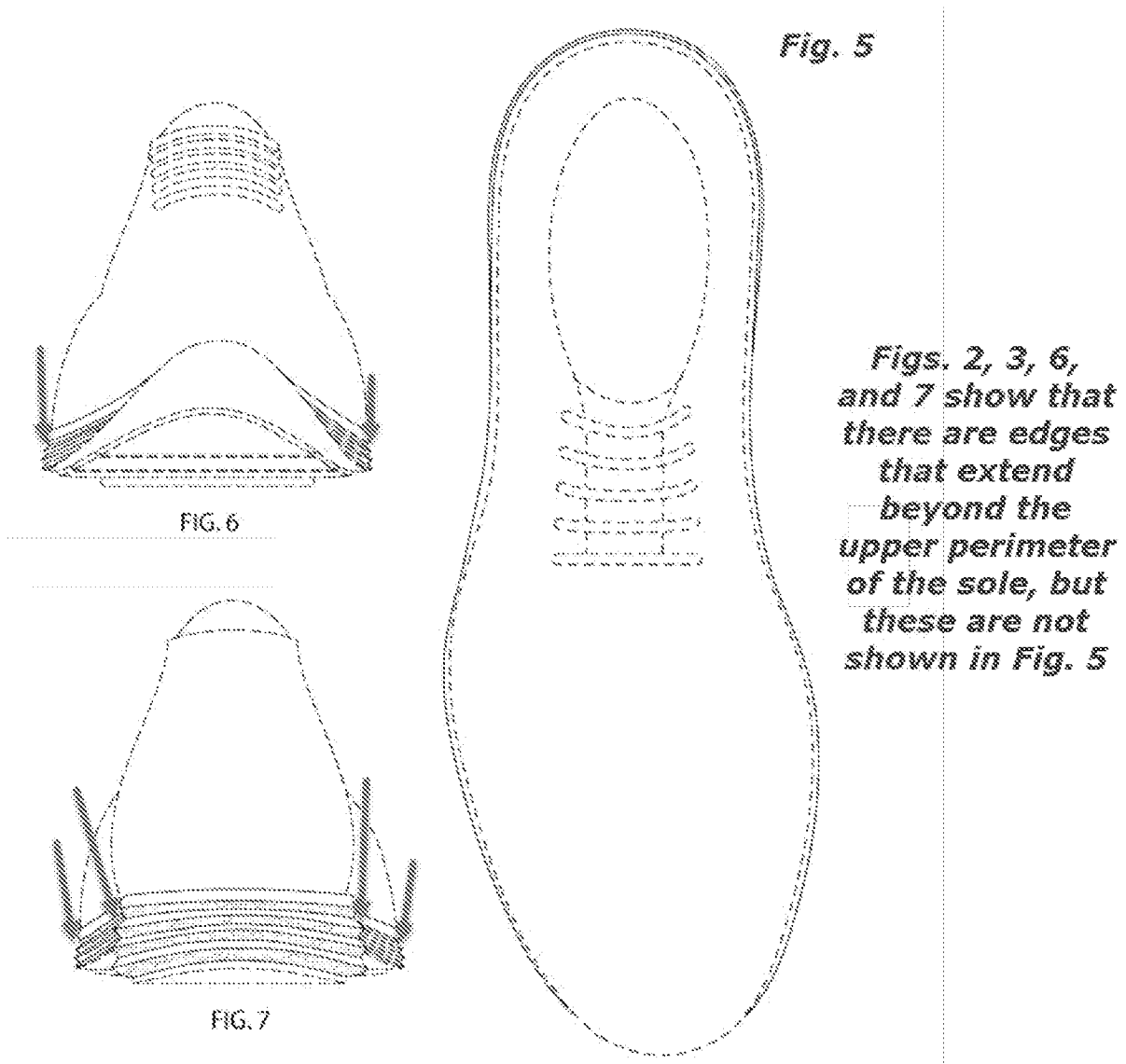

It was the understanding of the examiner that the midsole depicted in this application is identical to the midsole of copending application 29/542,314, which also claimed the sole bottom. It is noted that the original and corrected drawings of the copending application show this area without the inconsistencies between views noted above (the inconsistencies that were noted in that application were corrected in

Art Unit: 2914

replacement drawings). If this is the case, applicant may look to those drawings to see how the inconsistencies of the instant application might be made consistent.

It is suggested that in order to overcome the part of the rejection related to inconsistencies between the drawings, the views should be made consistent in their depiction of the claimed design.

When preparing new drawings, care must be exercised to avoid introduction of anything that could be construed to be new matter prohibited by 35 U.S.C. 132 and 37 CFR 1.121.

Any amended replacement drawing sheet should include all of the figures appearing on the immediate prior version of the sheet, even if only one figure is being amended. The figure or figure number of an amended drawing should not be labeled as "amended." Each drawing sheet submitted after the filing date of an application must be labeled in the top margin as either "Replacement Sheet" or "New Sheet" pursuant to 37 CFR 1.121(d). If the changes are not accepted by the examiner, the applicant will be notified and informed of any suggested corrective action in the next Office action.

Summation

The claim stands rejected for the reasons set forth above.

The references cited but not applied, are considered cumulative art related to the claimed design. Further consideration of the references relative to the claimed design will be made upon resolution of the rejection above.

Art Unit: 2914

Conclusion

Any inquiry concerning this communication or earlier communications from the examiner should be directed to T. Chase Nelson whose telephone number is 571-272-2641. The examiner can normally be reached Monday through Friday from approximately 9:00 AM to 3:15 PM and at various times throughout the week and weekend.

If attempts to reach the examiner by telephone are unsuccessful, the examiner's supervisor, Celia Murphy, can be reached at 571-272-2654. The fax phone number for the organization where this application or proceeding is assigned is 571-273-8300.

Information regarding the status of an application may be obtained from the Patent Application Information Retrieval (PAIR) system. Status information for published applications may be obtained from either Private PAIR or Public PAIR. Status information for unpublished applications is available through Private PAIR only. For more information about the PAIR system, see <http://pair-direct.uspto.gov>. Should you have questions on access to the Private PAIR system, contact the Electronic Business Center (EBC) at 866-217-9197 (toll-free).

/T. Chase Nelson/

Primary Examiner, Art Unit 2914

Notice of References Cited	Application/Control No. 29/542,318	Applicant(s)/Patent Under Reexamination BOYS, JACK	
	Examiner T. Chase Nelson	Art Unit 2914	Page 1 of 6

U.S. PATENT DOCUMENTS

*		Document Number Country Code-Number-Kind Code	Date MM-YYYY	Name	CPC Classification	US Classification
*	A	US-D120,248 S	04-1940	Sbicca		D2/950
*	B	US-D157,034 S	01-1950	Eldon		D2/902
*	C	US-D235,701 S	07-1975	Famolare		D2/947
*	D	US-D265,018 S	06-1982	Vermonet; Christian		D2/954
*	E	US-D266,798 S	11-1982	Famolare, Jr.; Joseph P.		D2/950
*	F	US-D268,299 S	03-1983	Argyropoulos; James P.		D2/960
*	G	US-D268,221 S	03-1983	Argyropoulos; James P.		D2/950
*	H	US-4,680,877 A	07-1987	Fink; Hans	A43B7/06	36/3B
*	I	US-4,918,838 A	04-1990	Chang; David J. H.	A43B1/0018	36/28
*	J	US-D321,584 S	11-1991	Mitsui; Shigeyuki		D2/977
*	K	US-D325,288 S	04-1992	Richard; Daniel		D2/977
*	L	US-D385,691 S	11-1997	Egelja; Sinisa		D2/946
*	M	US-D415,607 S	10-1999	Merceron; Jean Paul		D2/951

FOREIGN PATENT DOCUMENTS

*		Document Number Country Code-Number-Kind Code	Date MM-YYYY	Country	Name	CPC Classification
	N					
	O					
	P					
	Q					
	R					
	S					
	T					

NON-PATENT DOCUMENTS

*		Include as applicable: Author, Title Date, Publisher, Edition or Volume, Pertinent Pages)
	U	
	V	
	W	
	X	

*A copy of this reference is not being furnished with this Office action. (See MPEP § 707.05(a).)
Dates in MM-YYYY format are publication dates. Classifications may be US or foreign.

Notice of References Cited	Application/Control No. 29/542,318	Applicant(s)/Patent Under Reexamination BOYS, JACK	
	Examiner T. Chase Nelson	Art Unit 2914	Page 2 of 6

U.S. PATENT DOCUMENTS

*		Document Number Country Code-Number-Kind Code	Date MM-YYYY	Name	CPC Classification	US Classification
*	A	US-D432,292 S	10-2000	Kim; Karen J.		D2/902
*	B	US-D434,547 S	12-2000	Kim; Karen J.		D2/902
*	C	US-D466,278 S	12-2002	Smith, III; Wilson W.		D2/977
*	D	US-2005/0016021 A1	01-2005	Marvin, William	A43B13/14	36/29
*	E	US-D511,617 S	11-2005	Matis; Clark A.		D2/947
*	F	US-7,047,670 B2	05-2006	Marvin; William	A43B13/20	36/28
*	G	US-2007/0169379 A1	07-2007	Hazenberg; K. Pieter	A43B13/125	36/102
*	H	US-D554,840 S	11-2007	McClaskie; Thomas E.		D2/953
*	I	US-D564,741 S	03-2008	Covatch; Charles E.		D2/953
*	J	US-7,353,625 B2	04-2008	Ellis; Todd	A43B7/144	36/28
*	K	US-D576,393 S	09-2008	Kaufman; Paul		D2/947
*	L	US-D579,649 S	11-2008	McDowell; Sean M.		D2/970
*	M	US-D593,741 S	06-2009	Vico; Andrea		D2/951

FOREIGN PATENT DOCUMENTS

*		Document Number Country Code-Number-Kind Code	Date MM-YYYY	Country	Name	Classification
	N					
	O					
	P					
	Q					
	R					
	S					
	T					

NON-PATENT DOCUMENTS

*		Include as applicable: Author, Title Date, Publisher, Edition or Volume, Pertinent Pages)
	U	
	V	
	W	
	X	

*A copy of this reference is not being furnished with this Office action. (See MPEP § 707.05(a).)
Dates in MM-YYYY format are publication dates. Classifications may be US or foreign.

Notice of References Cited	Application/Control No. 29/542,318	Applicant(s)/Patent Under Reexamination BOYS, JACK	
	Examiner T. Chase Nelson	Art Unit 2914	Page 3 of 6

U.S. PATENT DOCUMENTS

*		Document Number Country Code-Number-Kind Code	Date MM-YYYY	Name	CPC Classification	US Classification
*	A	US-7,752,772 B2	07-2010	Hatfield; Tobie D.	A43B7/1415	36/29
*	B	US-D624,291 S	09-2010	Henderson; Jeffrey A.		D2/946
*	C	US-D636,567 S	04-2011	Raysse; David		D2/946
*	D	US-7,941,938 B2	05-2011	Yu; Sui-Chieh	A43B7/1415	36/25R
*	E	US-D643,189 S	08-2011	Teteriatnikov; Savva		D2/946
*	F	US-2012/0005920 A1	01-2012	Alvear; Isaac	A43B13/125	36/28
*	G	US-2012/0096744 A1	04-2012	GOODSMITH; Tracy	A43B3/108	36/103
*	H	US-D659,958 S	05-2012	Birkinhead; Toby		D2/946
*	I	US-D662,698 S	07-2012	Pulli; Kyle R.		D2/947
*	J	US-D663,927 S	07-2012	Teng-Lee; Albert		D2/947
*	K	US-D666,795 S	09-2012	Shaffer; Benjamin A.		D2/947
*	L	US-D669,255 S	10-2012	Birkinhead; Toby		D2/947
*	M	US-D680,308 S	04-2013	Hardman; Tony		D2/947

FOREIGN PATENT DOCUMENTS

*		Document Number Country Code-Number-Kind Code	Date MM-YYYY	Country	Name	Classification
	N					
	O					
	P					
	Q					
	R					
	S					
	T					

NON-PATENT DOCUMENTS

*		Include as applicable: Author, Title Date, Publisher, Edition or Volume, Pertinent Pages)
	U	
	V	
	W	
	X	

*A copy of this reference is not being furnished with this Office action. (See MPEP § 707.05(a).)
Dates in MM-YYYY format are publication dates. Classifications may be US or foreign.

Notice of References Cited	Application/Control No. 29/542,318	Applicant(s)/Patent Under Reexamination BOYS, JACK	
	Examiner T. Chase Nelson	Art Unit 2914	Page 4 of 6

U.S. PATENT DOCUMENTS

*		Document Number Country Code-Number-Kind Code	Date MM-YYYY	Name	CPC Classification	US Classification
*	A	US-2013/0125424 A1	05-2013	Lee; Neville Ka Shek	A43B7/081	36/25R
*	B	US-D685,166 S	07-2013	Hatfield; Tinker L.		D2/947
*	C	US-D692,217 S	10-2013	Fogg; Peter M.		D2/947
*	D	US-D694,497 S	12-2013	Taylor; Justin R.		D2/947
*	E	US-D694,498 S	12-2013	Carboy; Shawn G.		D2/947
*	F	US-D694,499 S	12-2013	Williams, Jr.; Robert C.		D2/947
*	G	US-8,607,474 B2	12-2013	Spanks; Jeffrey C.	A43B1/0027	36/11.5
*	H	US-D696,852 S	01-2014	Madore; Carl L.		D2/972
*	I	US-2014/0059883 A1	03-2014	Adeagbo; Simidele A.	A43B13/187	36/28
*	J	US-D707,949 S	07-2014	VanHook; Nathan		D2/972
*	K	US-D710,579 S	08-2014	Williams, Jr.; Robert C.		D2/947
*	L	US-D713,625 S	09-2014	Raasch; Dylan		D2/947
*	M	US-D714,035 S	09-2014	O'Connor; Kelly		D2/947

FOREIGN PATENT DOCUMENTS

*		Document Number Country Code-Number-Kind Code	Date MM-YYYY	Country	Name	Classification
	N					
	O					
	P					
	Q					
	R					
	S					
	T					

NON-PATENT DOCUMENTS

*		Include as applicable: Author, Title Date, Publisher, Edition or Volume, Pertinent Pages)
	U	
	V	
	W	
	X	

*A copy of this reference is not being furnished with this Office action. (See MPEP § 707.05(a).)
Dates in MM-YYYY format are publication dates. Classifications may be US or foreign.

Notice of References Cited	Application/Control No. 29/542,318	Applicant(s)/Patent Under Reexamination BOYS, JACK	
	Examiner T. Chase Nelson	Art Unit 2914	Page 5 of 6

U.S. PATENT DOCUMENTS

*		Document Number Country Code-Number-Kind Code	Date MM-YYYY	Name	CPC Classification	US Classification
*	A	US-2014/0259789 A1	09-2014	Dojan; Frederick J.	A43B1/0018	36/103
*	B	US-D714,037 S	09-2014	Della Valle; Andrea		D2/950
*	C	US-D717,034 S	11-2014	Bramani; Marco		D2/951
*	D	US-D723,773 S	03-2015	Raysse; David		D2/947
*	E	US-2015/0150339 A1	06-2015	Van Hook; Nathan	A43B13/187	36/84
*	F	US-D731,767 S	06-2015	Lan; Chi Tsang		D2/947
*	G	US-D735,453 S	08-2015	Monroy; Jose Rafael		D2/951
*	H	US-D737,039 S	08-2015	Pauk; Matthew		D2/972
*	I	US-D735,462 S	08-2015	Pauk; Matthew		D2/972
*	J	US-D737,040 S	08-2015	Pauk; Matthew		D2/972
*	K	US-D742,107 S	11-2015	Kasprzak; Dieter		D2/951
*	L	US-D743,153 S	11-2015	Taylor; Justin		D2/947
*	M	US-2015/0342300 A1	12-2015	Cin; David Jonathan	A43B13/386	36/103

FOREIGN PATENT DOCUMENTS

*		Document Number Country Code-Number-Kind Code	Date MM-YYYY	Country	Name	Classification
	N					
	O					
	P					
	Q					
	R					
	S					
	T					

NON-PATENT DOCUMENTS

*		Include as applicable: Author, Title Date, Publisher, Edition or Volume, Pertinent Pages)
	U	
	V	
	W	
	X	

*A copy of this reference is not being furnished with this Office action. (See MPEP § 707.05(a).)
Dates in MM-YYYY format are publication dates. Classifications may be US or foreign.

Notice of References Cited	Application/Control No. 29/542,318	Applicant(s)/Patent Under Reexamination BOYS, JACK	
	Examiner T. Chase Nelson	Art Unit 2914	Page 6 of 6

U.S. PATENT DOCUMENTS

*	Document Number Country Code-Number-Kind Code	Date MM-YYYY	Name	CPC Classification	US Classification
*	A US-D747,083 S	01-2016	Verfi; Mattias		D2/947
*	B US-D747,600 S	01-2016	Greenhalgh; John S.		D2/977
*	C US-D746,560 S	01-2016	Verfi; Mattias		D2/947
*	D US-D748,383 S	02-2016	Raysse; David		D2/947
	E US-				
	F US-				
	G US-				
	H US-				
	I US-				
	J US-				
	K US-				
	L US-				
	M US-				

FOREIGN PATENT DOCUMENTS

*	Document Number Country Code-Number-Kind Code	Date MM-YYYY	Country	Name	Classification
	N				
	O				
	P				
	Q				
	R				
	S				
	T				

NON-PATENT DOCUMENTS

*	Document Number Country Code-Number-Kind Code	Date MM-YYYY	Country	Name	Classification
	Include as applicable: Author, Title Date, Publisher, Edition or Volume, Pertinent Pages)				
	U				
	V				
	W				
	X				

*A copy of this reference is not being furnished with this Office action. (See MPEP § 707.05(a).)
Dates in MM-YYYY format are publication dates. Classifications may be US or foreign.

INFORMATION DISCLOSURE STATEMENT BY APPLICANT (Not for submission under 37 CFR 1.99)	Application Number		29542318
	Filing Date		2015-10-13
	First Named Inventor	Jack Boys	
	Art Unit		2913
	Examiner Name	Not Yet Assigned	
	Attorney Docket Number		56503-149126

U.S.PATENTS						Remove
Examiner Initial*	Cite No	Patent Number	Kind Code ¹	Issue Date	Name of Patentee or Applicant of cited Document	Pages,Columns,Lines where Relevant Passages or Relevant Figures Appear
/T.N./	1	4680877		1987-07-21	Fink	
	2	7941938		2011-05-17	Yu et al.	
	3	D398743	S	1998-09-29	Rask	
	4	D430723		2000-09-12	Kim	
	5	D498901		2004-11-30	Hawker et al.	
	6	D509049		2005-09-06	McClaskie	
	7	D623835		2010-09-21	Tzenos	
	8	D634108		2011-03-15	Tzenos	

**INFORMATION DISCLOSURE
STATEMENT BY APPLICANT**
(Not for submission under 37 CFR 1.99)

Application Number	29542318	29542318 - GAU: 2914
Filing Date	2015-10-13	
First Named Inventor	Jack Boys	
Art Unit	2913	
Examiner Name	Not Yet Assigned	
Attorney Docket Number	56503-149126	

/T.N./	9	D671306		2012-11-27	Tzenos	
↓	10	D671723		2012-12-04	Teteriatnikov	
↓	11	D672123	S	2012-12-11	Williams, Jr.	
↓	12	D685567	S	2013-07-09	Dolce	
↓	13	D690088	S	2013-09-24	Hardman	
↓	14	D713626	S	2014-09-23	Raasch	

If you wish to add additional U.S. Patent citation information please click the Add button. Add

U.S.PATENT APPLICATION PUBLICATIONS

Remove

Examiner Initial*	Cite No	Publication Number	Kind Code ¹	Publication Date	Name of Patentee or Applicant of cited Document	Pages,Columns,Lines where Relevant Passages or Relevant Figures Appear
/T.N./	1	20140150298	A1	2014-06-05	Crowley et al.	

If you wish to add additional U.S. Published Application citation information please click the Add button. Add

FOREIGN PATENT DOCUMENTS

Remove

Examiner Initial*	Cite No	Foreign Document Number ³	Country Code ² i	Kind Code ⁴	Publication Date	Name of Patentee or Applicant of cited Document	Pages,Columns,Lines where Relevant Passages or Relevant Figures Appear	T ⁵

INFORMATION DISCLOSURE STATEMENT BY APPLICANT (Not for submission under 37 CFR 1.99)	Application Number	29542318	29542318 - GAU: 2914
	Filing Date	2015-10-13	
	First Named Inventor	Jack Boys	
	Art Unit	2913	
	Examiner Name	Not Yet Assigned	
	Attorney Docket Number	56503-149126	

	1								<input type="checkbox"/>
--	---	--	--	--	--	--	--	--	--------------------------

If you wish to add additional Foreign Patent Document citation information please click the Add button **Add**

NON-PATENT LITERATURE DOCUMENTS **Remove**

Examiner Initials*	Cite No	Include name of the author (in CAPITAL LETTERS), title of the article (when appropriate), title of the item (book, magazine, journal, serial, symposium, catalog, etc), date, pages(s), volume-issue number(s), publisher, city and/or country where published.	T ⁵
	1		<input type="checkbox"/>

If you wish to add additional non-patent literature document citation information please click the Add button **Add**

EXAMINER SIGNATURE

Examiner Signature	/T. Chase Nelson/	Date Considered	02/22/2016
--------------------	-------------------	-----------------	------------

*EXAMINER: Initial if reference considered, whether or not citation is in conformance with MPEP 609. Draw line through a citation if not in conformance and not considered. Include copy of this form with next communication to applicant.

¹ See Kind Codes of USPTO Patent Documents at www.USPTO.GOV or MPEP 901.04. ² Enter office that issued the document, by the two-letter code (WIPO Standard ST.3). ³ For Japanese patent documents, the indication of the year of the reign of the Emperor must precede the serial number of the patent document. ⁴ Kind of document by the appropriate symbols as indicated on the document under WIPO Standard ST.16 if possible. ⁵ Applicant is to place a check mark here if English language translation is attached.

INFORMATION DISCLOSURE STATEMENT BY APPLICANT (Not for submission under 37 CFR 1.99)	Application Number	29542318	29542318 - GAU: 2914
	Filing Date	2015-10-13	
	First Named Inventor	Jack Boys	
	Art Unit	2913	
	Examiner Name	Not Yet Assigned	
	Attorney Docket Number	56503-149126	

CERTIFICATION STATEMENT

Please see 37 CFR 1.97 and 1.98 to make the appropriate selection(s):

That each item of information contained in the information disclosure statement was first cited in any communication from a foreign patent office in a counterpart foreign application not more than three months prior to the filing of the information disclosure statement. See 37 CFR 1.97(e)(1).

OR

That no item of information contained in the information disclosure statement was cited in a communication from a foreign patent office in a counterpart foreign application, and, to the knowledge of the person signing the certification after making reasonable inquiry, no item of information contained in the information disclosure statement was known to any individual designated in 37 CFR 1.56(c) more than three months prior to the filing of the information disclosure statement. See 37 CFR 1.97(e)(2).

- See attached certification statement.
- The fee set forth in 37 CFR 1.17 (p) has been submitted herewith.
- A certification statement is not submitted herewith.

SIGNATURE

A signature of the applicant or representative is required in accordance with CFR 1.33, 10.18. Please see CFR 1.4(d) for the form of the signature.

Signature	/Alan H. Norman/	Date (YYYY-MM-DD)	2015-11-04
Name/Print	Alan H. Norman	Registration Number	32285

This collection of information is required by 37 CFR 1.97 and 1.98. The information is required to obtain or retain a benefit by the public which is to file (and by the USPTO to process) an application. Confidentiality is governed by 35 U.S.C. 122 and 37 CFR 1.14. This collection is estimated to take 1 hour to complete, including gathering, preparing and submitting the completed application form to the USPTO. Time will vary depending upon the individual case. Any comments on the amount of time you require to complete this form and/or suggestions for reducing this burden, should be sent to the Chief Information Officer, U.S. Patent and Trademark Office, U.S. Department of Commerce, P.O. Box 1450, Alexandria, VA 22313-1450. **DO NOT SEND FEES OR COMPLETED FORMS TO THIS ADDRESS. SEND TO: Commissioner for Patents, P.O. Box 1450, Alexandria, VA 22313-1450.**

Privacy Act Statement

The Privacy Act of 1974 (P.L. 93-579) requires that you be given certain information in connection with your submission of the attached form related to a patent application or patent. Accordingly, pursuant to the requirements of the Act, please be advised that: (1) the general authority for the collection of this information is 35 U.S.C. 2(b)(2); (2) furnishing of the information solicited is voluntary; and (3) the principal purpose for which the information is used by the U.S. Patent and Trademark Office is to process and/or examine your submission related to a patent application or patent. If you do not furnish the requested information, the U.S. Patent and Trademark Office may not be able to process and/or examine your submission, which may result in termination of proceedings or abandonment of the application or expiration of the patent.

The information provided by you in this form will be subject to the following routine uses:

1. The information on this form will be treated confidentially to the extent allowed under the Freedom of Information Act (5 U.S.C. 552) and the Privacy Act (5 U.S.C. 552a). Records from this system of records may be disclosed to the Department of Justice to determine whether the Freedom of Information Act requires disclosure of these records.
2. A record from this system of records may be disclosed, as a routine use, in the course of presenting evidence to a court, magistrate, or administrative tribunal, including disclosures to opposing counsel in the course of settlement negotiations.
3. A record in this system of records may be disclosed, as a routine use, to a Member of Congress submitting a request involving an individual, to whom the record pertains, when the individual has requested assistance from the Member with respect to the subject matter of the record.
4. A record in this system of records may be disclosed, as a routine use, to a contractor of the Agency having need for the information in order to perform a contract. Recipients of information shall be required to comply with the requirements of the Privacy Act of 1974, as amended, pursuant to 5 U.S.C. 552a(m).
5. A record related to an International Application filed under the Patent Cooperation Treaty in this system of records may be disclosed, as a routine use, to the International Bureau of the World Intellectual Property Organization, pursuant to the Patent Cooperation Treaty.
6. A record in this system of records may be disclosed, as a routine use, to another federal agency for purposes of National Security review (35 U.S.C. 181) and for review pursuant to the Atomic Energy Act (42 U.S.C. 218(c)).
7. A record from this system of records may be disclosed, as a routine use, to the Administrator, General Services, or his/her designee, during an inspection of records conducted by GSA as part of that agency's responsibility to recommend improvements in records management practices and programs, under authority of 44 U.S.C. 2904 and 2906. Such disclosure shall be made in accordance with the GSA regulations governing inspection of records for this purpose, and any other relevant (i.e., GSA or Commerce) directive. Such disclosure shall not be used to make determinations about individuals.
8. A record from this system of records may be disclosed, as a routine use, to the public after either publication of the application pursuant to 35 U.S.C. 122(b) or issuance of a patent pursuant to 35 U.S.C. 151. Further, a record may be disclosed, subject to the limitations of 37 CFR 1.14, as a routine use, to the public if the record was filed in an application which became abandoned or in which the proceedings were terminated and which application is referenced by either a published application, an application open to public inspections or an issued patent.
9. A record from this system of records may be disclosed, as a routine use, to a Federal, State, or local law enforcement agency, if the USPTO becomes aware of a violation or potential violation of law or regulation.



UNITED STATES PATENT AND TRADEMARK OFFICE

UNITED STATES DEPARTMENT OF COMMERCE
 United States Patent and Trademark Office
 Address: COMMISSIONER FOR PATENTS
 P.O. Box 1450
 Alexandria, Virginia 22313-1450
 www.uspto.gov

BIB DATA SHEET

CONFIRMATION NO. 7943

SERIAL NUMBER 29/542,318	FILING or 371(c) DATE 10/13/2015 RULE	CLASS D02	GROUP ART UNIT 2914	ATTORNEY DOCKET NO. 56503-149126	
APPLICANTS Cole Haan LLC, New York, NY INVENTORS Jack Boys, Greenland, NH; ** CONTINUING DATA ***** ** FOREIGN APPLICATIONS ***** ** IF REQUIRED, FOREIGN FILING LICENSE GRANTED ** 10/15/2015					
Foreign Priority claimed <input type="checkbox"/> Yes <input checked="" type="checkbox"/> No 35 USC 119(a-d) conditions met <input type="checkbox"/> Yes <input type="checkbox"/> No Verified and Acknowledged <u>/T. CHASE NELSON/</u> Examiner's Signature	<input type="checkbox"/> Met after Allowance Initials _____	STATE OR COUNTRY NH	SHEETS DRAWINGS 6	TOTAL CLAIMS 1	INDEPENDENT CLAIMS 1
ADDRESS THOMPSON COBURN LLP ONE US BANK PLAZA SUITE 3500 ST LOUIS, MO 63101 UNITED STATES					
TITLE Shoe Midsole					
FILING FEE RECEIVED 900	FEES: Authority has been given in Paper No. _____ to charge/credit DEPOSIT ACCOUNT No. _____ for following:		<input type="checkbox"/> All Fees <input type="checkbox"/> 1.16 Fees (Filing) <input type="checkbox"/> 1.17 Fees (Processing Ext. of time) <input type="checkbox"/> 1.18 Fees (Issue) <input type="checkbox"/> Other _____ <input type="checkbox"/> Credit		

Search Notes 	Application/Control No. 29542318	Applicant(s)/Patent Under Reexamination BOYS, JACK
	Examiner T. CHASE NELSON	Art Unit 2914

CPC- SEARCHED		
Symbol	Date	Examiner
A43B13/00,02,023,026,04,08,10,12,14,141,143,16,18,181,187,189,20,22,223,24,28,30,32,34,36	12.4.15	TCN
search above updated	1.27.16	TCN

CPC COMBINATION SETS - SEARCHED		
Symbol	Date	Examiner

US CLASSIFICATION SEARCHED			
Class	Subclass	Date	Examiner
D2	902,906,908,916,918,925,946-962,977	12.4.15	TCN
36	3B,22R,24.5,25R,28,32R,34R,59C,67A,103		
	searches above updated	2.22.16	TCN

SEARCH NOTES		
Search Notes	Date	Examiner
Referred to copending and other cases by same applicant inventor name search	2.22.16	TCN
EAST backward/forward search		
EAST assignee search , "Cole Haan"		
update EAST searches		

INTERFERENCE SEARCH			
US Class/ CPC Symbol	US Subclass / CPC Group	Date	Examiner
D2	947-960	2.22.16	TCN

--	--

PATENT

IN THE UNITED STATES PATENT AND TRADEMARK OFFICE
CERTIFICATE OF ELECTRONIC FILING

I hereby certify that this correspondence has been electronically filed with the U.S. Patent and Trademark Office via the EFS Web on June 1, 2016.

/Alan H. Norman/
Alan H. Norman
Reg. No. 32,285

In re application of: Boys, Jack	:	Examiner: Nelson, Thornton C.
	:	
Serial No.: 29/542,318	:	Confirmation No: 7943
	:	
Filed: October 13, 2015	:	Group Art Unit: 2914
	:	
For: SHOE SOLE	:	

RESPONSE TO OFFICE ACTION OF MARCH 1, 2016

Applicant submits the following amendments and remarks in response to the office action having a notification date of March 1, 2016.

REMARKS

Applicant submits with this response replacement sheets for Figures 2, 3, and 5-7. No new matter has been added in the replacement sheets.

A. The Examiner Should Withdraw the 35 USC 112 (a) and (b) Rejections In View of the Replacement Sheets.

The replacement sheets for Figures 2, 3, and 5-7 overcome the 35 U.S.C. § 112(a) and (b) rejections contained within the office action. Figures 2 and 3 have been amended to clarify that neither the toe region of the sole nor the bottom boundary line adjacent the stippled shaded region of the lowermost flute are claimed. Figures 2 and 3 have also been amended to clarify that the unclaimed upper connects with the upper boundary of the unclaimed toe region at the peak of the toe region, making clear that the upper boundary of unclaimed toe region does not contain a valley region as suggested by the Examiner on Page 3 of the office action. As amended, Figures 2 and 3 are consistent with Figures 1, 4, and 6.

Figure 5 has been amended to include an additional dashed line in the toe region of the sole to show a thickness of the sole that exists between the forwardmost portion of the sole and the forwardmost portion of the upper. Figure 5 has also been amended to show the outermost edges of the flutes extending beyond the perimeter of the upper when the shoe is shown in a top plan view. As amended, Figure 5 is consistent with Figures 2, 3, 6, and 7.

Figure 7 has been amended to clarify that the bottom boundary line adjacent the stippled shaded region of the lowermost flute adjacent the stippled shaded region is not claimed.

Application No. 29/542,318
Attorney Docket No. 56503-149126

In view of the replacement sheets submitted herewith, the Examiner should withdraw the 35 USC § 112 (a) and (b) rejections. Should the Examiner need any additional information or request further changes, Applicant invites the Examiner to contact the undersigned at the number below.

Respectfully submitted,

Thompson Coburn LLP

By: /Alan H. Norman/
Alan H. Norman
Reg. No. 32,285
One US Bank Plaza
St. Louis, MO 63101-1693
(314) 552-6284

REPLACEMENT SHEET

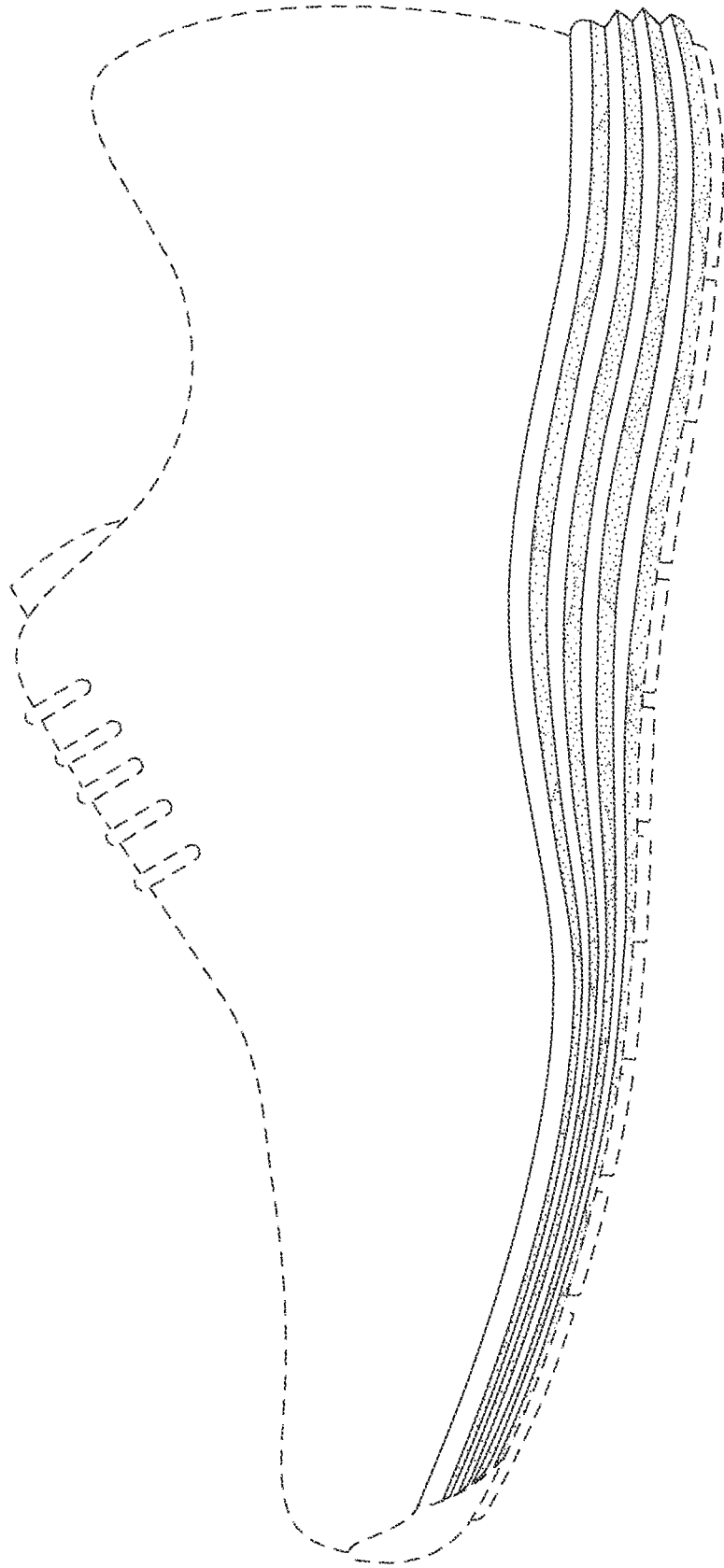

FIG. 2

REPLACEMENT SHEET

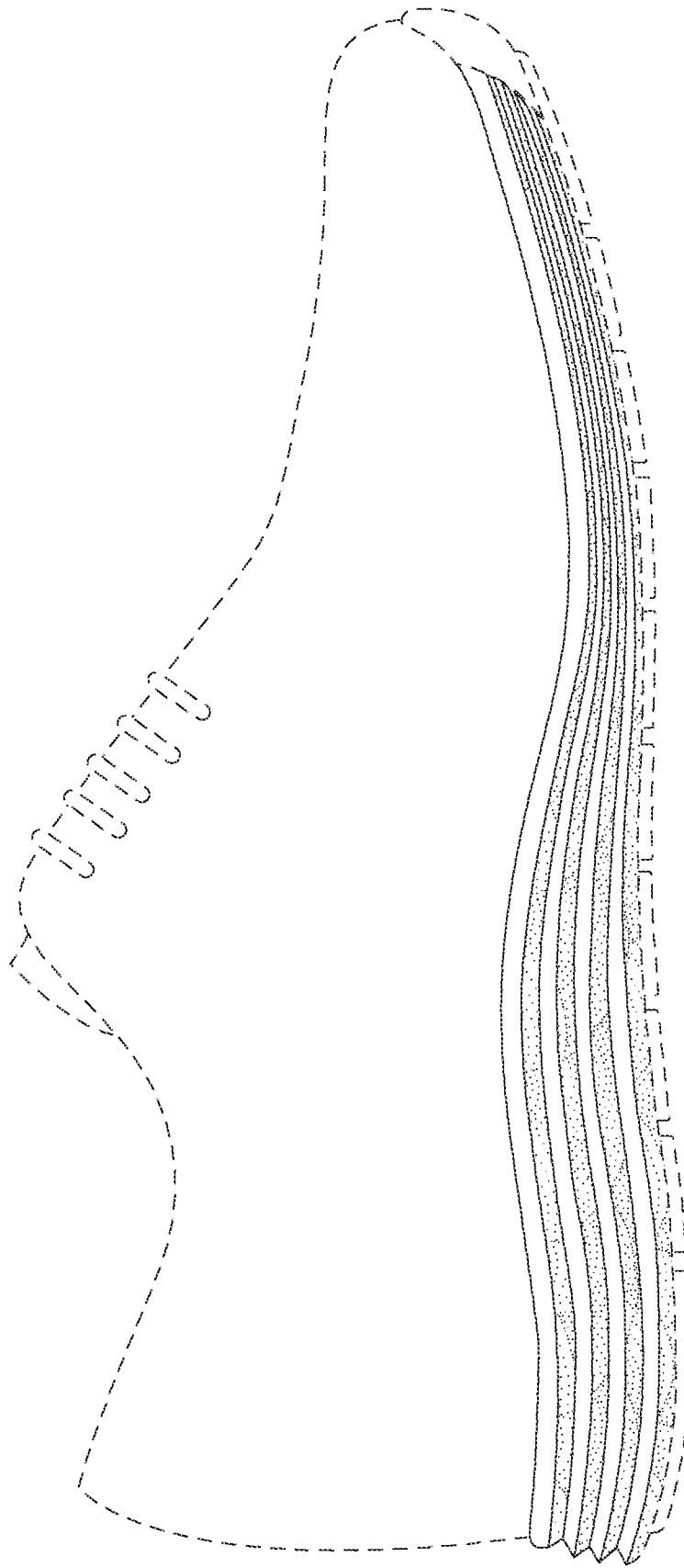

FIG. 3

REPLACEMENT SHEET

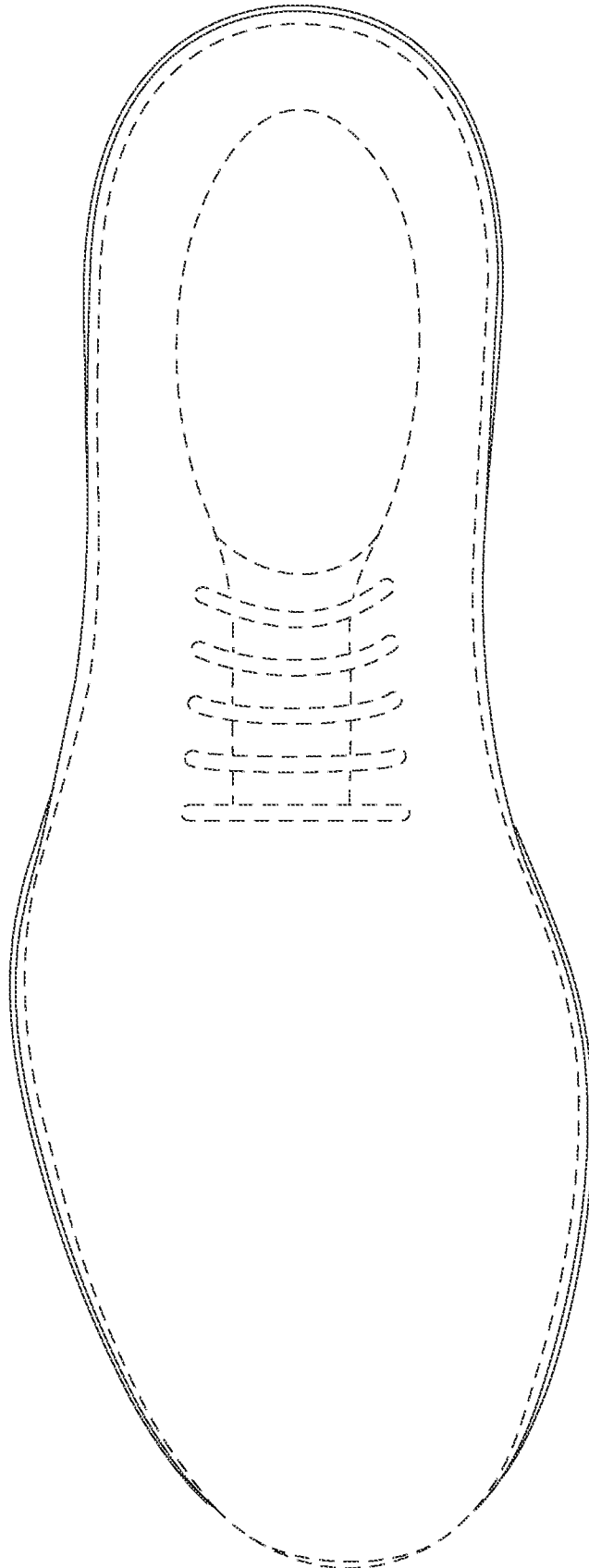

FIG. 5

REPLACEMENT SHEET

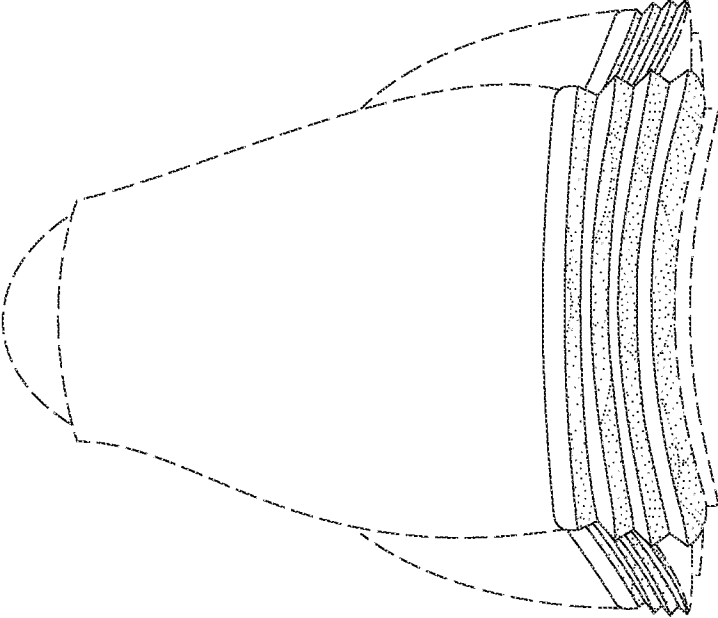

FIG. 7

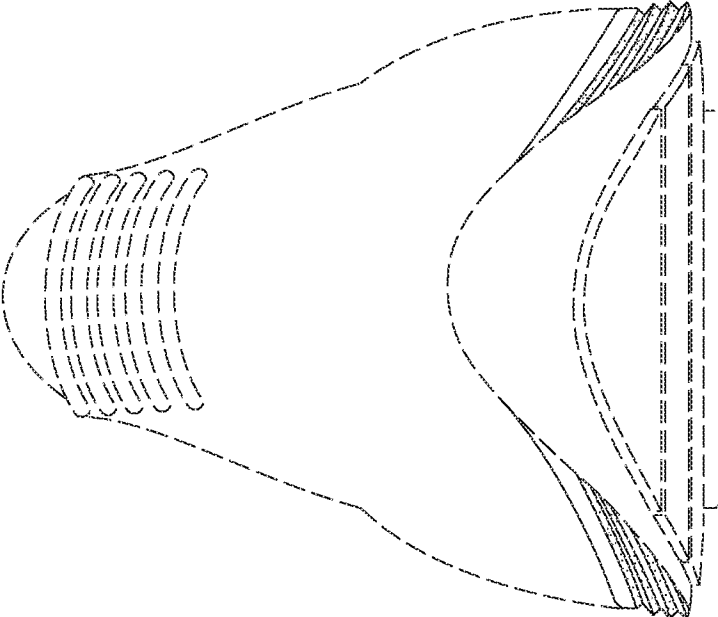

FIG. 6

Electronic Patent Application Fee Transmittal

Application Number:	29542318
Filing Date:	13-Oct-2015
Title of Invention:	Shoe Midsole
First Named Inventor/Applicant Name:	Jack Boys
Filer:	Alan Norman/Kristen Godar
Attorney Docket Number:	56503-149126

Filed as Large Entity

Filing Fees for Design

Description	Fee Code	Quantity	Amount	Sub-Total in USD(\$)
Basic Filing:				
Pages:				
Claims:				
Miscellaneous-Filing:				
Petition:				
Patent-Appeals-and-Interference:				
Post-Allowance-and-Post-Issuance:				
Extension-of-Time:				

Description	Fee Code	Quantity	Amount	Sub-Total in USD(\$)
Extension - 3 months with \$0 paid	1253	1	1400	1400
Miscellaneous:				
Total in USD (\$)				1400

Electronic Acknowledgement Receipt

EFS ID:	25942807
Application Number:	29542318
International Application Number:	
Confirmation Number:	7943
Title of Invention:	Shoe Midsole
First Named Inventor/Applicant Name:	Jack Boys
Customer Number:	21888
Filer:	Alan Norman/Kristen Godar
Filer Authorized By:	Alan Norman
Attorney Docket Number:	56503-149126
Receipt Date:	01-JUN-2016
Filing Date:	13-OCT-2015
Time Stamp:	18:13:33
Application Type:	Design

Payment information:

Submitted with Payment	yes
Payment Type	Deposit Account
Payment was successfully received in RAM	\$1400
RAM confirmation Number	5782
Deposit Account	200823
Authorized User	NORMAN, ALAN H

The Director of the USPTO is hereby authorized to charge indicated fees and credit any overpayment as follows:

Charge any Additional Fees required under 37 CFR 1.17 (Patent application and reexamination processing fees)

Charge any Additional Fees required under 37 CFR 1.21 (Miscellaneous fees and charges)

File Listing:

Document Number	Document Description	File Name	File Size(Bytes)/ Message Digest	Multi Part /.zip	Pages (if appl.)
1		Response.pdf	145428 af5c984be67d28c95e0ee138b83d3ad844b31713	yes	3
Multipart Description/PDF files in .zip description					
	Document Description		Start		End
	Amendment/Req. Reconsideration-After Non-Final Reject		1		1
	Applicant Arguments/Remarks Made in an Amendment		2		3
Warnings:					
Information:					
2	Drawings-only black and white line drawings	ReplacementSheets.pdf	3446464 cc9f13d502064c4e900ab8fd67d2cfc58b9886eb	no	4
Warnings:					
The page size in the PDF is too large. The pages should be 8.5 x 11 or A4. If this PDF is submitted, the pages will be resized upon entry into the Image File Wrapper and may affect subsequent processing					
Information:					
3	Fee Worksheet (SB06)	fee-info.pdf	30140 b0bee0c2e819622bc71f50a8b5219837eb880c7a	no	2
Warnings:					
Information:					
Total Files Size (in bytes):			3622032		

This Acknowledgement Receipt evidences receipt on the noted date by the USPTO of the indicated documents, characterized by the applicant, and including page counts, where applicable. It serves as evidence of receipt similar to a Post Card, as described in MPEP 503.

New Applications Under 35 U.S.C. 111

If a new application is being filed and the application includes the necessary components for a filing date (see 37 CFR 1.53(b)-(d) and MPEP 506), a Filing Receipt (37 CFR 1.54) will be issued in due course and the date shown on this Acknowledgement Receipt will establish the filing date of the application.

National Stage of an International Application under 35 U.S.C. 371

If a timely submission to enter the national stage of an international application is compliant with the conditions of 35 U.S.C. 371 and other applicable requirements a Form PCT/DO/EO/903 indicating acceptance of the application as a national stage submission under 35 U.S.C. 371 will be issued in addition to the Filing Receipt, in due course.

New International Application Filed with the USPTO as a Receiving Office

If a new international application is being filed and the international application includes the necessary components for an international filing date (see PCT Article 11 and MPEP 1810), a Notification of the International Application Number and of the International Filing Date (Form PCT/RO/105) will be issued in due course, subject to prescriptions concerning national security, and the date shown on this Acknowledgement Receipt will establish the international filing date of the application.

SCORE Placeholder Sheet for IFW Content

Application Number: 29542318

Document Date: 06/01/2016

The presence of this form in the IFW record indicates that the following document type was received in electronic format on the date identified above. This content is stored in the SCORE database.

Since this was an electronic submission, there is no physical artifact folder, no artifact folder is recorded in PALM, and no paper documents or physical media exist. The TIFF images in the IFW record were created from the original documents that are stored in SCORE.

- Drawing

At the time of document entry (noted above):

- USPTO employees may access SCORE content via eDAN using the Supplemental Content tab, or via the SCORE web page.
- External customers may access SCORE content via PAIR using the Supplemental Content tab.

Document code: WFEE

United States Patent and Trademark Office
Sales Receipt for Accounting Date: 08/02/2016

PWILSON ADJ #00000001 Mailroom Dt: 06/01/2016
Seq No: 5782 Sales Acctg Dt: 06/02/2016 200823 29542318
01 FC : 1253 1400.00 CR

Application No. 29/542,318
Attorney Docket No. 56503-149126

IN THE UNITED STATES PATENT AND TRADEMARK OFFICE

CERTIFICATE OF E-FILING

I hereby certify that this correspondence has been e-filed with the U.S. Patent and Trademark Office on July 18, 2016.

/Alan H. Norman/
Alan H. Norman
Reg. No. 32,285

In re application of:	:	
Boys, Jack	:	Confirmation No. 7943
	:	
Serial No.: 29/542,318	:	Examiner: Nelson, Thornton C.
	:	
Filing Date: October 13, 2015	:	Group Art Unit: 2914
	:	
For: SHOE SOLE	:	

REQUEST FOR REFUND OF EXTENSION FEE

An Amendment and Response and replacement drawings were filed in the above-referenced U.S. patent application on June 1, 2016, along with the payment of a large entity three-month extension of time fee. Applicant inadvertently paid a three-month extension of time fee of \$1,400, although no extension of time fee was due. Therefore, Applicant respectfully requests that Deposit Account No. 20-0823 be credited in the amount of \$1,400.

Application No. 29/542318
Attorney Docket No. 56503-149126

Respectfully submitted,

/Alan H. Norman/
Alan H. Norman
Reg. No. 32,285
Thompson Coburn LLP
One US Bank Plaza
St. Louis, Missouri 63101-9928
(314) 552-6284 (ph)
(314-)552-7000 (fax)

6398800.1

Electronic Acknowledgement Receipt

EFS ID:	26372834
Application Number:	29542318
International Application Number:	
Confirmation Number:	7943
Title of Invention:	Shoe Midsole
First Named Inventor/Applicant Name:	Jack Boys
Customer Number:	21888
Filer:	Alan Norman
Filer Authorized By:	
Attorney Docket Number:	56503-149126
Receipt Date:	18-JUL-2016
Filing Date:	13-OCT-2015
Time Stamp:	11:40:18
Application Type:	Design

Payment information:

Submitted with Payment	no
------------------------	----

File Listing:

Document Number	Document Description	File Name	File Size(Bytes)/ Message Digest	Multi Part /.zip	Pages (if appl.)
1	Refund Request	Req_for_Refund_of_Extension_of_Time_Fee.pdf	196843 c98d56c8f5d4cf2816f1095b925228bd8edf0d56	no	2

Warnings:

Information:	
Total Files Size (in bytes):	196843
<p>This Acknowledgement Receipt evidences receipt on the noted date by the USPTO of the indicated documents, characterized by the applicant, and including page counts, where applicable. It serves as evidence of receipt similar to a Post Card, as described in MPEP 503.</p> <p><u>New Applications Under 35 U.S.C. 111</u> If a new application is being filed and the application includes the necessary components for a filing date (see 37 CFR 1.53(b)-(d) and MPEP 506), a Filing Receipt (37 CFR 1.54) will be issued in due course and the date shown on this Acknowledgement Receipt will establish the filing date of the application.</p> <p><u>National Stage of an International Application under 35 U.S.C. 371</u> If a timely submission to enter the national stage of an international application is compliant with the conditions of 35 U.S.C. 371 and other applicable requirements a Form PCT/DO/EO/903 indicating acceptance of the application as a national stage submission under 35 U.S.C. 371 will be issued in addition to the Filing Receipt, in due course.</p> <p><u>New International Application Filed with the USPTO as a Receiving Office</u> If a new international application is being filed and the international application includes the necessary components for an international filing date (see PCT Article 11 and MPEP 1810), a Notification of the International Application Number and of the International Filing Date (Form PCT/RO/105) will be issued in due course, subject to prescriptions concerning national security, and the date shown on this Acknowledgement Receipt will establish the international filing date of the application.</p>	

INFORMATION DISCLOSURE STATEMENT BY APPLICANT (Not for submission under 37 CFR 1.99)	Application Number	29542318
	Filing Date	2015-10-13
	First Named Inventor	Jack Boys
	Art Unit	2914
	Examiner Name	T. C. Nelson
	Attorney Docket Number	56503-149126

U.S.PATENTS						Remove
Examiner Initial*	Cite No	Patent Number	Kind Code ¹	Issue Date	Name of Patentee or Applicant of cited Document	Pages,Columns,Lines where Relevant Passages or Relevant Figures Appear
	1	2394704	A	1946-02-12	Loewer	
	2	4364190	A	1982-12-21	Yonkers	
	3	4785557	A	1988-11-22	Kelley et al.	
	4	5216824	A	1993-06-08	Blissett et al.	
	5	5918385	A	1999-07-06	Sessa	
	6	8732986	B2	2014-05-27	Miner	
	7	D190162	S	1961-04-25	Hubbard	
	8	D294537	S	1988-03-08	Le	

**INFORMATION DISCLOSURE
STATEMENT BY APPLICANT**
(Not for submission under 37 CFR 1.99)

Application Number		29542318
Filing Date		2015-10-13
First Named Inventor	Jack Boys	
Art Unit		2914
Examiner Name	T. C. Nelson	
Attorney Docket Number		56503-149126

9	D368576	S	1996-04-09	Assous
10	D394143	S	1998-05-12	Sink
11	D399345	S	1998-10-13	Koh
12	D476800	S	2003-07-08	Fuerst
13	D565283	S	2008-04-01	Smith et al.
14	D568594	S	2008-05-13	Ringholz
15	D568594		2008-05-13	Ringholz
16	D611692	S	2010-03-16	Bizzo
17	D632876	S	2011-02-22	Choi
18	D643602		2011-08-23	Teteriatnikov
19	D660568	S	2012-05-29	Blakeslee

**INFORMATION DISCLOSURE
STATEMENT BY APPLICANT**
(Not for submission under 37 CFR 1.99)

Application Number	29542318
Filing Date	2015-10-13
First Named Inventor	Jack Boys
Art Unit	2914
Examiner Name	T. C. Nelson
Attorney Docket Number	56503-149126

20	D667619	S	2012-09-25	Blakeslee
21	D675003	S	2013-01-29	Leon et al.
22	D684348	S	2013-06-18	Castellon
23	D693553	S	2013-11-19	McClaskie
24	D709676	S	2014-07-29	Iachini
25	D725356	S	2015-03-31	Miner
26	D730034	S	2015-05-26	Henderson
27	D730035	S	2015-05-26	Henderson
28	D740007	S	2015-10-06	Lan
29	D747083	S	2016-01-12	Verfl

If you wish to add additional U.S. Patent citation information please click the Add button.

Add

U.S.PATENT APPLICATION PUBLICATIONS

Remove

**INFORMATION DISCLOSURE
STATEMENT BY APPLICANT**
(Not for submission under 37 CFR 1.99)

Application Number	29542318
Filing Date	2015-10-13
First Named Inventor	Jack Boys
Art Unit	2914
Examiner Name	T. C. Nelson
Attorney Docket Number	56503-149126

Examiner Initial*	Cite No	Publication Number	Kind Code ¹	Publication Date	Name of Patentee or Applicant of cited Document	Pages, Columns, Lines where Relevant Passages or Relevant Figures Appear
	1	20050217140	A1	2005-10-06	Melis	
	2	20060048412	A1	2006-03-09	Kerrigan	
	3	20080141563	A1	2008-06-19	Meschan	
	4	20090045546	A1	2009-02-19	Schindler et al.	
	5	20110232130	A1	2011-09-29	BOUDREAU et al.	
	6	20130232821	A1	2013-09-12	Schindler et al.	
	7	20130247422	A1	2013-09-26	Holt et al.	
	8	20140305006	A1	2014-10-16	Azoulay	
	9	20150016021	A1	2015-01-15	Lane et al.	
	10	20150101215	A1	2015-04-16	Henderson et al.	

**INFORMATION DISCLOSURE
STATEMENT BY APPLICANT**
(Not for submission under 37 CFR 1.99)

Application Number	29542318
Filing Date	2015-10-13
First Named Inventor	Jack Boys
Art Unit	2914
Examiner Name	T. C. Nelson
Attorney Docket Number	56503-149126

11	20150143722	A1	2015-05-28	Faggin et al.
----	-------------	----	------------	---------------

If you wish to add additional U.S. Published Application citation information please click the Add button.

FOREIGN PATENT DOCUMENTS

Examiner Initial*	Cite No	Foreign Document Number ³	Country Code ² i	Kind Code ⁴	Publication Date	Name of Patentee or Applicant of cited Document	Pages, Columns, Lines where Relevant Passages or Relevant Figures Appear	T ⁵
	1							

If you wish to add additional Foreign Patent Document citation information please click the Add button.

NON-PATENT LITERATURE DOCUMENTS

Examiner Initials*	Cite No	Include name of the author (in CAPITAL LETTERS), title of the article (when appropriate), title of the item (book, magazine, journal, serial, symposium, catalog, etc), date, pages(s), volume-issue number(s), publisher, city and/or country where published.	T ⁵
	1		

If you wish to add additional non-patent literature document citation information please click the Add button.

EXAMINER SIGNATURE

Examiner Signature		Date Considered	
--------------------	--	-----------------	--

*EXAMINER: Initial if reference considered, whether or not citation is in conformance with MPEP 609. Draw line through a citation if not in conformance and not considered. Include copy of this form with next communication to applicant.

¹ See Kind Codes of USPTO Patent Documents at www.USPTO.GOV or MPEP 901.04. ² Enter office that issued the document, by the two-letter code (WIPO Standard ST.3). ³ For Japanese patent documents, the indication of the year of the reign of the Emperor must precede the serial number of the patent document. ⁴ Kind of document by the appropriate symbols as indicated on the document under WIPO Standard ST.16 if possible. ⁵ Applicant is to place a check mark here if English language translation is attached.

**INFORMATION DISCLOSURE
STATEMENT BY APPLICANT**
(Not for submission under 37 CFR 1.99)

Application Number	29542318		
Filing Date	2015-10-13		
First Named Inventor	Jack Boys		
Art Unit	2914		
Examiner Name	T. C. Nelson		
Attorney Docket Number	56503-149126		

CERTIFICATION STATEMENT

Please see 37 CFR 1.97 and 1.98 to make the appropriate selection(s):

That each item of information contained in the information disclosure statement was first cited in any communication from a foreign patent office in a counterpart foreign application not more than three months prior to the filing of the information disclosure statement. See 37 CFR 1.97(e)(1).

OR

That no item of information contained in the information disclosure statement was cited in a communication from a foreign patent office in a counterpart foreign application, and, to the knowledge of the person signing the certification after making reasonable inquiry, no item of information contained in the information disclosure statement was known to any individual designated in 37 CFR 1.56(c) more than three months prior to the filing of the information disclosure statement. See 37 CFR 1.97(e)(2).

See attached certification statement.

- The fee set forth in 37 CFR 1.17 (p) has been submitted herewith.
- A certification statement is not submitted herewith.

SIGNATURE

A signature of the applicant or representative is required in accordance with CFR 1.33, 10.18. Please see CFR 1.4(d) for the form of the signature.

Signature	/Alan H. Norman/	Date (YYYY-MM-DD)	2016-07-19
Name/Print	Alan H. Norman	Registration Number	32285

This collection of information is required by 37 CFR 1.97 and 1.98. The information is required to obtain or retain a benefit by the public which is to file (and by the USPTO to process) an application. Confidentiality is governed by 35 U.S.C. 122 and 37 CFR 1.14. This collection is estimated to take 1 hour to complete, including gathering, preparing and submitting the completed application form to the USPTO. Time will vary depending upon the individual case. Any comments on the amount of time you require to complete this form and/or suggestions for reducing this burden, should be sent to the Chief Information Officer, U.S. Patent and Trademark Office, U.S. Department of Commerce, P.O. Box 1450, Alexandria, VA 22313-1450. **DO NOT SEND FEES OR COMPLETED FORMS TO THIS ADDRESS. SEND TO: Commissioner for Patents, P.O. Box 1450, Alexandria, VA 22313-1450.**

Privacy Act Statement

The Privacy Act of 1974 (P.L. 93-579) requires that you be given certain information in connection with your submission of the attached form related to a patent application or patent. Accordingly, pursuant to the requirements of the Act, please be advised that: (1) the general authority for the collection of this information is 35 U.S.C. 2(b)(2); (2) furnishing of the information solicited is voluntary; and (3) the principal purpose for which the information is used by the U.S. Patent and Trademark Office is to process and/or examine your submission related to a patent application or patent. If you do not furnish the requested information, the U.S. Patent and Trademark Office may not be able to process and/or examine your submission, which may result in termination of proceedings or abandonment of the application or expiration of the patent.

The information provided by you in this form will be subject to the following routine uses:

1. The information on this form will be treated confidentially to the extent allowed under the Freedom of Information Act (5 U.S.C. 552) and the Privacy Act (5 U.S.C. 552a). Records from this system of records may be disclosed to the Department of Justice to determine whether the Freedom of Information Act requires disclosure of these records.
2. A record from this system of records may be disclosed, as a routine use, in the course of presenting evidence to a court, magistrate, or administrative tribunal, including disclosures to opposing counsel in the course of settlement negotiations.
3. A record in this system of records may be disclosed, as a routine use, to a Member of Congress submitting a request involving an individual, to whom the record pertains, when the individual has requested assistance from the Member with respect to the subject matter of the record.
4. A record in this system of records may be disclosed, as a routine use, to a contractor of the Agency having need for the information in order to perform a contract. Recipients of information shall be required to comply with the requirements of the Privacy Act of 1974, as amended, pursuant to 5 U.S.C. 552a(m).
5. A record related to an International Application filed under the Patent Cooperation Treaty in this system of records may be disclosed, as a routine use, to the International Bureau of the World Intellectual Property Organization, pursuant to the Patent Cooperation Treaty.
6. A record in this system of records may be disclosed, as a routine use, to another federal agency for purposes of National Security review (35 U.S.C. 181) and for review pursuant to the Atomic Energy Act (42 U.S.C. 218(c)).
7. A record from this system of records may be disclosed, as a routine use, to the Administrator, General Services, or his/her designee, during an inspection of records conducted by GSA as part of that agency's responsibility to recommend improvements in records management practices and programs, under authority of 44 U.S.C. 2904 and 2906. Such disclosure shall be made in accordance with the GSA regulations governing inspection of records for this purpose, and any other relevant (i.e., GSA or Commerce) directive. Such disclosure shall not be used to make determinations about individuals.
8. A record from this system of records may be disclosed, as a routine use, to the public after either publication of the application pursuant to 35 U.S.C. 122(b) or issuance of a patent pursuant to 35 U.S.C. 151. Further, a record may be disclosed, subject to the limitations of 37 CFR 1.14, as a routine use, to the public if the record was filed in an application which became abandoned or in which the proceedings were terminated and which application is referenced by either a published application, an application open to public inspections or an issued patent.
9. A record from this system of records may be disclosed, as a routine use, to a Federal, State, or local law enforcement agency, if the USPTO becomes aware of a violation or potential violation of law or regulation.

Electronic Patent Application Fee Transmittal

Application Number:	29542318
Filing Date:	13-Oct-2015
Title of Invention:	Shoe Midsole
First Named Inventor/Applicant Name:	Jack Boys
Filer:	Alan Norman/Megan Remer
Attorney Docket Number:	56503-149126

Filed as Large Entity

Filing Fees for Design

Description	Fee Code	Quantity	Amount	Sub-Total in USD(\$)
Basic Filing:				
Pages:				
Claims:				
Miscellaneous-Filing:				
Petition:				
Patent-Appeals-and-Interference:				
Post-Allowance-and-Post-Issuance:				
Extension-of-Time:				

Description	Fee Code	Quantity	Amount	Sub-Total in USD(\$)
Miscellaneous:				
Submission- Information Disclosure Stmt	1806	1	180	180
Total in USD (\$)				180

Electronic Acknowledgement Receipt

EFS ID:	26387324
Application Number:	29542318
International Application Number:	
Confirmation Number:	7943
Title of Invention:	Shoe Midsole
First Named Inventor/Applicant Name:	Jack Boys
Customer Number:	21888
Filer:	Alan Norman/Megan Remer
Filer Authorized By:	Alan Norman
Attorney Docket Number:	56503-149126
Receipt Date:	19-JUL-2016
Filing Date:	13-OCT-2015
Time Stamp:	12:23:56
Application Type:	Design

Payment information:

Submitted with Payment	yes
Payment Type	DA
Payment was successfully received in RAM	\$180
RAM confirmation Number	071916INTEFSW00010771200823
Deposit Account	200823
Authorized User	Megan Remer

The Director of the USPTO is hereby authorized to charge indicated fees and credit any overpayment as follows:

--	--	--	--	--	--

File Listing:

Document Number	Document Description	File Name	File Size(Bytes)/ Message Digest	Multi Part /.zip	Pages (if appl.)
1	Information Disclosure Statement (IDS) Form (SB08)	Supplemental-Information-Disclosure-Statement.pdf	1036087	no	7
			5cf355e865013d781326701babfcd338ea21bc30		

Warnings:

Information:

2	Fee Worksheet (SB06)	fee-info.pdf	30048	no	2
			666bfb99f4655b1026dc3b4316698ba83bdb714		

Warnings:

Information:

Total Files Size (in bytes):	1066135
-------------------------------------	---------

This Acknowledgement Receipt evidences receipt on the noted date by the USPTO of the indicated documents, characterized by the applicant, and including page counts, where applicable. It serves as evidence of receipt similar to a Post Card, as described in MPEP 503.

New Applications Under 35 U.S.C. 111

If a new application is being filed and the application includes the necessary components for a filing date (see 37 CFR 1.53(b)-(d) and MPEP 506), a Filing Receipt (37 CFR 1.54) will be issued in due course and the date shown on this Acknowledgement Receipt will establish the filing date of the application.

National Stage of an International Application under 35 U.S.C. 371

If a timely submission to enter the national stage of an international application is compliant with the conditions of 35 U.S.C. 371 and other applicable requirements a Form PCT/DO/EO/903 indicating acceptance of the application as a national stage submission under 35 U.S.C. 371 will be issued in addition to the Filing Receipt, in due course.

New International Application Filed with the USPTO as a Receiving Office

If a new international application is being filed and the international application includes the necessary components for an international filing date (see PCT Article 11 and MPEP 1810), a Notification of the International Application Number and of the International Filing Date (Form PCT/RO/105) will be issued in due course, subject to prescriptions concerning national security, and the date shown on this Acknowledgement Receipt will establish the international filing date of the application.



NOTICE OF ALLOWANCE AND FEE(S) DUE

21888 7590 07/21/2016
THOMPSON COBURN LLP
ONE US BANK PLAZA
SUITE 3500
ST LOUIS, MO 63101

Table with 2 columns: EXAMINER (NELSON, THORNTON C), ART UNIT (2914), PAPER NUMBER (7943)

DATE MAILED: 07/21/2016

Table with 5 columns: APPLICATION NO. (29/542,318), FILING DATE (10/13/2015), FIRST NAMED INVENTOR (Jack Boys), ATTORNEY DOCKET NO. (56503-149126), CONFIRMATION NO. (7943)

TITLE OF INVENTION: Shoe Midsole

Table with 7 columns: APPLN. TYPE (nonprovisional), ENTITY STATUS (UNDISCOUNTED), ISSUE FEE DUE (\$560), PUBLICATION FEE DUE (\$0), PREV. PAID ISSUE FEE (\$0), TOTAL FEE(S) DUE (\$560), DATE DUE (10/21/2016)

THE APPLICATION IDENTIFIED ABOVE HAS BEEN EXAMINED AND IS ALLOWED FOR ISSUANCE AS A PATENT. PROSECUTION ON THE MERITS IS CLOSED. THIS NOTICE OF ALLOWANCE IS NOT A GRANT OF PATENT RIGHTS. THIS APPLICATION IS SUBJECT TO WITHDRAWAL FROM ISSUE AT THE INITIATIVE OF THE OFFICE OR UPON PETITION BY THE APPLICANT. SEE 37 CFR 1.313 AND MPEP 1308.

THE ISSUE FEE AND PUBLICATION FEE (IF REQUIRED) MUST BE PAID WITHIN THREE MONTHS FROM THE MAILING DATE OF THIS NOTICE OR THIS APPLICATION SHALL BE REGARDED AS ABANDONED. THIS STATUTORY PERIOD CANNOT BE EXTENDED. SEE 35 U.S.C. 151. THE ISSUE FEE DUE INDICATED ABOVE DOES NOT REFLECT A CREDIT FOR ANY PREVIOUSLY PAID ISSUE FEE IN THIS APPLICATION. IF AN ISSUE FEE HAS PREVIOUSLY BEEN PAID IN THIS APPLICATION (AS SHOWN ABOVE), THE RETURN OF PART B OF THIS FORM WILL BE CONSIDERED A REQUEST TO REAPPLY THE PREVIOUSLY PAID ISSUE FEE TOWARD THE ISSUE FEE NOW DUE.

HOW TO REPLY TO THIS NOTICE:

I. Review the ENTITY STATUS shown above. If the ENTITY STATUS is shown as SMALL or MICRO, verify whether entitlement to that entity status still applies. If the ENTITY STATUS is the same as shown above, pay the TOTAL FEE(S) DUE shown above. If the ENTITY STATUS is changed from that shown above, on PART B - FEE(S) TRANSMITTAL, complete section number 5 titled "Change in Entity Status (from status indicated above)". For purposes of this notice, small entity fees are 1/2 the amount of undiscounted fees, and micro entity fees are 1/2 the amount of small entity fees.

II. PART B - FEE(S) TRANSMITTAL, or its equivalent, must be completed and returned to the United States Patent and Trademark Office (USPTO) with your ISSUE FEE and PUBLICATION FEE (if required). If you are charging the fee(s) to your deposit account, section "4b" of Part B - Fee(s) Transmittal should be completed and an extra copy of the form should be submitted. If an equivalent of Part B is filed, a request to reapply a previously paid issue fee must be clearly made, and delays in processing may occur due to the difficulty in recognizing the paper as an equivalent of Part B.

III. All communications regarding this application must give the application number. Please direct all communications prior to issuance to Mail Stop ISSUE FEE unless advised to the contrary.

IMPORTANT REMINDER: Utility patents issuing on applications filed on or after Dec. 12, 1980 may require payment of maintenance fees. It is patentee's responsibility to ensure timely payment of maintenance fees when due.

PART B - FEE(S) TRANSMITTAL

**Complete and send this form, together with applicable fee(s), to: Mail Mail Stop ISSUE FEE
 Commissioner for Patents
 P.O. Box 1450
 Alexandria, Virginia 22313-1450
 or Fax (571)-273-2885**

INSTRUCTIONS: This form should be used for transmitting the ISSUE FEE and PUBLICATION FEE (if required). Blocks 1 through 5 should be completed where appropriate. All further correspondence including the Patent, advance orders and notification of maintenance fees will be mailed to the current correspondence address as indicated unless corrected below or directed otherwise in Block 1, by (a) specifying a new correspondence address; and/or (b) indicating a separate "FEE ADDRESS" for maintenance fee notifications.

Note: A certificate of mailing can only be used for domestic mailings of the Fee(s) Transmittal. This certificate cannot be used for any other accompanying papers. Each additional paper, such as an assignment or formal drawing, must have its own certificate of mailing or transmission.

CURRENT CORRESPONDENCE ADDRESS (Note: Use Block 1 for any change of address)

21888 7590 07/21/2016
THOMPSON COBURN LLP
 ONE US BANK PLAZA
 SUITE 3500
 ST LOUIS, MO 63101

Certificate of Mailing or Transmission

I hereby certify that this Fee(s) Transmittal is being deposited with the United States Postal Service with sufficient postage for first class mail in an envelope addressed to the Mail Stop ISSUE FEE address above, or being facsimile transmitted to the USPTO (571) 273-2885, on the date indicated below.

(Depositor's name)
(Signature)
(Date)

APPLICATION NO.	FILING DATE	FIRST NAMED INVENTOR	ATTORNEY DOCKET NO.	CONFIRMATION NO.
29/542,318	10/13/2015	Jack Boys	56503-149126	7943

TITLE OF INVENTION: Shoe Midsole

APPLN. TYPE	ENTITY STATUS	ISSUE FEE DUE	PUBLICATION FEE DUE	PREV. PAID ISSUE FEE	TOTAL FEE(S) DUE	DATE DUE
nonprovisional	UNDISCOUNTED	\$560	\$0	\$0	\$560	10/21/2016

EXAMINER	ART UNIT	CLASS-SUBCLASS
NELSON, THORNTON C	2914	D02-947000

<p>1. Change of correspondence address or indication of "Fee Address" (37 CFR 1.363).</p> <p><input type="checkbox"/> Change of correspondence address (or Change of Correspondence Address form PTO/SB/122) attached.</p> <p><input type="checkbox"/> "Fee Address" indication (or "Fee Address" Indication form PTO/SB/47; Rev 03-02 or more recent) attached. Use of a Customer Number is required.</p>	<p>2. For printing on the patent front page, list</p> <p>(1) The names of up to 3 registered patent attorneys or agents OR, alternatively, 1 _____</p> <p>(2) The name of a single firm (having as a member a registered attorney or agent) and the names of up to 2 registered patent attorneys or agents. If no name is listed, no name will be printed. 2 _____</p> <p>3 _____</p>
---	---

3. ASSIGNEE NAME AND RESIDENCE DATA TO BE PRINTED ON THE PATENT (print or type)

PLEASE NOTE: Unless an assignee is identified below, no assignee data will appear on the patent. If an assignee is identified below, the document has been filed for recordation as set forth in 37 CFR 3.11. Completion of this form is NOT a substitute for filing an assignment.

(A) NAME OF ASSIGNEE _____ (B) RESIDENCE: (CITY and STATE OR COUNTRY) _____

Please check the appropriate assignee category or categories (will not be printed on the patent) : Individual Corporation or other private group entity Government

<p>4a. The following fee(s) are submitted:</p> <p><input type="checkbox"/> Issue Fee</p> <p><input type="checkbox"/> Publication Fee (No small entity discount permitted)</p> <p><input type="checkbox"/> Advance Order - # of Copies _____</p>	<p>4b. Payment of Fee(s): (Please first reapply any previously paid issue fee shown above)</p> <p><input type="checkbox"/> A check is enclosed.</p> <p><input type="checkbox"/> Payment by credit card. Form PTO-2038 is attached.</p> <p><input type="checkbox"/> The director is hereby authorized to charge the required fee(s), any deficiency, or credits any overpayment, to Deposit Account Number _____ (enclose an extra copy of this form).</p>
---	---

5. **Change in Entity Status** (from status indicated above)

Applicant certifying micro entity status. See 37 CFR 1.29

Applicant asserting small entity status. See 37 CFR 1.27

Applicant changing to regular undiscounted fee status.

NOTE: Absent a valid certification of Micro Entity Status (see forms PTO/SB/15A and 15B), issue fee payment in the micro entity amount will not be accepted at the risk of application abandonment.

NOTE: If the application was previously under micro entity status, checking this box will be taken to be a notification of loss of entitlement to micro entity status.

NOTE: Checking this box will be taken to be a notification of loss of entitlement to small or micro entity status, as applicable.

NOTE: This form must be signed in accordance with 37 CFR 1.31 and 1.33. See 37 CFR 1.4 for signature requirements and certifications.

Authorized Signature _____ Date _____

Typed or printed name _____ Registration No. _____



UNITED STATES PATENT AND TRADEMARK OFFICE

UNITED STATES DEPARTMENT OF COMMERCE
United States Patent and Trademark Office
Address: COMMISSIONER FOR PATENTS
P.O. Box 1450
Alexandria, Virginia 22313-1450
www.uspto.gov

Table with 5 columns: APPLICATION NO., FILING DATE, FIRST NAMED INVENTOR, ATTORNEY DOCKET NO., CONFIRMATION NO.
29/542,318 10/13/2015 Jack Boys 56503-149126 7943

21888 7590 07/21/2016
THOMPSON COBURN LLP
ONE US BANK PLAZA
SUITE 3500
ST LOUIS, MO 63101

EXAMINER
NELSON, THORNTON C

ART UNIT 2914
PAPER NUMBER

DATE MAILED: 07/21/2016

Determination of Patent Term Extension or Adjustment under 35 U.S.C. 154 (b)

Design patents have a term measured from the issue date of the patent and the term remains the same length regardless of the time that the application for the design patent was pending. Since the above-identified application is an application for a design patent, the patent is not eligible for Patent Term Extension or Adjustment under 35 U.S.C. 154(b).

Any questions regarding the Patent Term Extension or Adjustment determination should be directed to the Office of Patent Legal Administration at (571)-272-7702. Questions relating to issue and publication fee payments should be directed to the Customer Service Center of the Office of Patent Publication at 1-(888)-786-0101 or (571)-272-4200.

OMB Clearance and PRA Burden Statement for PTOL-85 Part B

The Paperwork Reduction Act (PRA) of 1995 requires Federal agencies to obtain Office of Management and Budget approval before requesting most types of information from the public. When OMB approves an agency request to collect information from the public, OMB (i) provides a valid OMB Control Number and expiration date for the agency to display on the instrument that will be used to collect the information and (ii) requires the agency to inform the public about the OMB Control Number's legal significance in accordance with 5 CFR 1320.5(b).

The information collected by PTOL-85 Part B is required by 37 CFR 1.311. The information is required to obtain or retain a benefit by the public which is to file (and by the USPTO to process) an application. Confidentiality is governed by 35 U.S.C. 122 and 37 CFR 1.14. This collection is estimated to take 12 minutes to complete, including gathering, preparing, and submitting the completed application form to the USPTO. Time will vary depending upon the individual case. Any comments on the amount of time you require to complete this form and/or suggestions for reducing this burden, should be sent to the Chief Information Officer, U.S. Patent and Trademark Office, U.S. Department of Commerce, P.O. Box 1450, Alexandria, Virginia 22313-1450. DO NOT SEND FEES OR COMPLETED FORMS TO THIS ADDRESS. SEND TO: Commissioner for Patents, P.O. Box 1450, Alexandria, Virginia 22313-1450. Under the Paperwork Reduction Act of 1995, no persons are required to respond to a collection of information unless it displays a valid OMB control number.

Privacy Act Statement

The Privacy Act of 1974 (P.L. 93-579) requires that you be given certain information in connection with your submission of the attached form related to a patent application or patent. Accordingly, pursuant to the requirements of the Act, please be advised that: (1) the general authority for the collection of this information is 35 U.S.C. 2(b)(2); (2) furnishing of the information solicited is voluntary; and (3) the principal purpose for which the information is used by the U.S. Patent and Trademark Office is to process and/or examine your submission related to a patent application or patent. If you do not furnish the requested information, the U.S. Patent and Trademark Office may not be able to process and/or examine your submission, which may result in termination of proceedings or abandonment of the application or expiration of the patent.

The information provided by you in this form will be subject to the following routine uses:

1. The information on this form will be treated confidentially to the extent allowed under the Freedom of Information Act (5 U.S.C. 552) and the Privacy Act (5 U.S.C. 552a). Records from this system of records may be disclosed to the Department of Justice to determine whether disclosure of these records is required by the Freedom of Information Act.
2. A record from this system of records may be disclosed, as a routine use, in the course of presenting evidence to a court, magistrate, or administrative tribunal, including disclosures to opposing counsel in the course of settlement negotiations.
3. A record in this system of records may be disclosed, as a routine use, to a Member of Congress submitting a request involving an individual, to whom the record pertains, when the individual has requested assistance from the Member with respect to the subject matter of the record.
4. A record in this system of records may be disclosed, as a routine use, to a contractor of the Agency having need for the information in order to perform a contract. Recipients of information shall be required to comply with the requirements of the Privacy Act of 1974, as amended, pursuant to 5 U.S.C. 552a(m).
5. A record related to an International Application filed under the Patent Cooperation Treaty in this system of records may be disclosed, as a routine use, to the International Bureau of the World Intellectual Property Organization, pursuant to the Patent Cooperation Treaty.
6. A record in this system of records may be disclosed, as a routine use, to another federal agency for purposes of National Security review (35 U.S.C. 181) and for review pursuant to the Atomic Energy Act (42 U.S.C. 218(c)).
7. A record from this system of records may be disclosed, as a routine use, to the Administrator, General Services, or his/her designee, during an inspection of records conducted by GSA as part of that agency's responsibility to recommend improvements in records management practices and programs, under authority of 44 U.S.C. 2904 and 2906. Such disclosure shall be made in accordance with the GSA regulations governing inspection of records for this purpose, and any other relevant (i.e., GSA or Commerce) directive. Such disclosure shall not be used to make determinations about individuals.
8. A record from this system of records may be disclosed, as a routine use, to the public after either publication of the application pursuant to 35 U.S.C. 122(b) or issuance of a patent pursuant to 35 U.S.C. 151. Further, a record may be disclosed, subject to the limitations of 37 CFR 1.14, as a routine use, to the public if the record was filed in an application which became abandoned or in which the proceedings were terminated and which application is referenced by either a published application, an application open to public inspection or an issued patent.
9. A record from this system of records may be disclosed, as a routine use, to a Federal, State, or local law enforcement agency, if the USPTO becomes aware of a violation or potential violation of law or regulation.

Notice of Allowability For A Design Application	Application No. 29/542,318	Applicant(s) BOYS, JACK	
	Examiner T. Chase Nelson	Art Unit 2914	AIA (First Inventor to File) Status Yes

-- The MAILING DATE of this communication appears on the cover sheet with the correspondence address--

All claims being allowable, PROSECUTION ON THE MERITS IS (OR REMAINS) CLOSED in this application. If not included herewith (or previously mailed), a Notice of Allowance (PTOL-85) or other appropriate communication will be mailed in due course. **THIS NOTICE OF ALLOWABILITY IS NOT A GRANT OF PATENT RIGHTS.** This application is subject to withdrawal from issue at the initiative of the Office or upon petition by the applicant. See 37 CFR 1.313 and MPEP 1308.

1. This communication is responsive to the response and drawing received 1 June 2016.
 A declaration(s)/affidavit(s) under **37 CFR 1.130(b)** was/were filed on _____.
2. An election was made by the applicant in response to a restriction requirement set forth during the interview on _____; the restriction requirement and election have been incorporated into this action.
3. The claim is allowed.
4. Acceptable drawings:
 - (a) The drawings filed on _____ are accepted by the Examiner.
 - (b) Drawing Figures 1, 4, filed on 13 October 2015 and drawing Figures 2-3, 5-7 filed on 1 June 2016 are accepted by the Examiner.
5. The claim for foreign priority under 35 U.S.C. § 119(a)-(d) or (f) is acknowledged.

Certified copies:

- a) All b) Some *c) None of the:
 1. Certified copies of the priority documents have been received.
 2. Certified copies of the priority documents have been received in Application No. _____.
 3. Copies of the certified copies of the priority documents have been received in this national stage application from the International Bureau (PCT Rule 17.2(a)).
- * Certified copies not received: _____.

Applicant has THREE MONTHS FROM THE "MAILING DATE" of this communication to file a reply complying with the requirements noted below. Failure to timely comply will result in ABANDONMENT of this application.

THIS THREE-MONTH PERIOD IS NOT EXTENDABLE.

6. CORRECTED DRAWINGS (as "replacement sheets") must be submitted.
 including changes required by the attached Examiner's Amendment / Comment or in the Office action of Paper No./Mail Date _____.
- Identifying indicia such as the application number (see 37 CFR 1.84(c)) should be written on the drawings in the front (not the back) of each sheet. Replacement sheet(s) should be labeled as such in the header according to 37 CFR 1.121(d).**

Attachment(s)

- | | |
|--|---|
| 1. <input type="checkbox"/> Notice of References Cited (PTO-892) | 4. <input type="checkbox"/> Examiner's Amendment/Comment |
| 2. <input type="checkbox"/> Information Disclosure Statements (PTO/SB/08),
Paper No./Receipt Date _____ | 5. <input type="checkbox"/> Examiner's Statement of Reasons for Allowance |
| 3. <input type="checkbox"/> Interview Summary (PTO-413),
Paper No./Mail Date _____ | 6. <input type="checkbox"/> Other _____. |

NOTE:	
/T. Chase Nelson/ Primary Examiner, Art Unit 2914	



UNITED STATES PATENT AND TRADEMARK OFFICE

UNITED STATES DEPARTMENT OF COMMERCE
United States Patent and Trademark Office
Address: COMMISSIONER FOR PATENTS
P.O. Box 1450
Alexandria, Virginia 22313-1450
www.uspto.gov

Table with 5 columns: APPLICATION NO., FILING DATE, FIRST NAMED INVENTOR, ATTORNEY DOCKET NO., CONFIRMATION NO.
29/542,318 10/13/2015 Jack Boys 56503-149126 7943

21888 7590 08/01/2016
THOMPSON COBURN LLP
ONE US BANK PLAZA
SUITE 3500
ST LOUIS, MO 63101

EXAMINER

NELSON, THORNTON C

ART UNIT PAPER NUMBER

2914

NOTIFICATION DATE DELIVERY MODE

08/01/2016

ELECTRONIC

Please find below and/or attached an Office communication concerning this application or proceeding.

The time period for reply, if any, is set in the attached communication.

Notice of the Office communication was sent electronically on above-indicated "Notification Date" to the following e-mail address(es):

IPDOCKET@THOMPSONCOBURN.COM

Corrected Notice of Allowability For A Design Application	Application No. 29/542,318	Applicant(s) BOYS, JACK	
	Examiner T. Chase Nelson	Art Unit 2914	AIA (First Inventor to File) Status Yes

-- The MAILING DATE of this communication appears on the cover sheet with the correspondence address--

All claims being allowable, PROSECUTION ON THE MERITS IS (OR REMAINS) CLOSED in this application. If not included herewith (or previously mailed), a Notice of Allowance (PTOL-85) or other appropriate communication will be mailed in due course. **THIS NOTICE OF ALLOWABILITY IS NOT A GRANT OF PATENT RIGHTS.** This application is subject to withdrawal from issue at the initiative of the Office or upon petition by the applicant. See 37 CFR 1.313 and MPEP 1308.

1. This communication is responsive to the IDS received 19 July 2016.
 A declaration(s)/affidavit(s) under **37 CFR 1.130(b)** was/were filed on _____.
2. An election was made by the applicant in response to a restriction requirement set forth during the interview on _____; the restriction requirement and election have been incorporated into this action.
3. The claim is allowed.
4. Acceptable drawings:
(a) The drawings filed on _____ are accepted by the Examiner.
(b) Drawing Figures 1, 4 filed on 13 October 2015 and drawing Figures 2-3, 5-7 filed on 1 June 2016 are accepted by the Examiner.
5. The claim for foreign priority under 35 U.S.C. § 119(a)-(d) or (f) is acknowledged.

Certified copies:

- a) All b) Some *c) None of the:
1. Certified copies of the priority documents have been received.
 2. Certified copies of the priority documents have been received in Application No. _____.
 3. Copies of the certified copies of the priority documents have been received in this national stage application from the International Bureau (PCT Rule 17.2(a)).
- * Certified copies not received: _____.

~~Applicant has THREE MONTHS FROM THE "MAILING DATE" of this communication to file a reply complying with the requirements noted below. Failure to timely comply will result in ABANDONMENT of this application. THIS THREE MONTH PERIOD IS NOT EXTENDABLE.~~

6. CORRECTED DRAWINGS (as "replacement sheets") must be submitted.
 including changes required by the attached Examiner's Amendment / Comment or in the Office action of Paper No./Mail Date _____.

Identifying indicia such as the application number (see 37 CFR 1.84(c)) should be written on the drawings in the front (not the back) of each sheet. Replacement sheet(s) should be labeled as such in the header according to 37 CFR 1.121(d).

Attachment(s)

- | | |
|---|---|
| <ol style="list-style-type: none"> 1. <input type="checkbox"/> Notice of References Cited (PTO-892) 2. <input checked="" type="checkbox"/> Information Disclosure Statements (PTO/SB/08),
Paper No./Receipt Date <u>20160719</u> 3. <input type="checkbox"/> Interview Summary (PTO-413),
Paper No./Mail Date _____. | <ol style="list-style-type: none"> 4. <input type="checkbox"/> Examiner's Amendment/Comment 5. <input type="checkbox"/> Examiner's Statement of Reasons for Allowance 6. <input type="checkbox"/> Other _____. |
|---|---|

NOTE:

/T. Chase Nelson/
Primary Examiner, Art Unit 2914

INFORMATION DISCLOSURE STATEMENT BY APPLICANT (Not for submission under 37 CFR 1.99)	Application Number	29542318
	Filing Date	2015-10-13
	First Named Inventor	Jack Boys
	Art Unit	2914
	Examiner Name	T. C. Nelson
	Attorney Docket Number	56503-149126

U.S.PATENTS						Remove
Examiner Initial*	Cite No	Patent Number	Kind Code ¹	Issue Date	Name of Patentee or Applicant of cited Document	Pages,Columns,Lines where Relevant Passages or Relevant Figures Appear
/T.N./ 	1	2394704	A	1946-02-12	Loewer	
	2	4364190	A	1982-12-21	Yonkers	
	3	4785557	A	1988-11-22	Kelley et al.	
	4	5216824	A	1993-06-08	Blissett et al.	
	5	5918385	A	1999-07-06	Sessa	
	6	8732986	B2	2014-05-27	Miner	
	7	D190162	S	1961-04-25	Hubbard	
	8	D294537	S	1988-03-08	Le	

**INFORMATION DISCLOSURE
STATEMENT BY APPLICANT**
(Not for submission under 37 CFR 1.99)

Application Number	29542318	29542318 - GAU: 2914
Filing Date	2015-10-13	
First Named Inventor	Jack Boys	
Art Unit	2914	
Examiner Name	T. C. Nelson	
Attorney Docket Number	56503-149126	

/T.N./	9	D368576	S	1996-04-09	Assous
	10	D394143	S	1998-05-12	Sink
	11	D399345	S	1998-10-13	Koh
	12	D476800	S	2003-07-08	Fuerst
	13	D565283	S	2008-04-01	Smith et al.
	14	D568594	S	2008-05-13	Ringholz
	15	D568594		2008-05-13	Ringholz
		duplicates reference #14			
/T.N./	16	D611692	S	2010-03-16	Bizzo
	17	D632876	S	2011-02-22	Choi
	18	D643602		2011-08-23	Teteriatnikov
	19	D660568	S	2012-05-29	Blakeslee

ALL REFERENCES CONSIDERED EXCEPT WHERE LINED THROUGH. /T.N./

**INFORMATION DISCLOSURE
STATEMENT BY APPLICANT**
(Not for submission under 37 CFR 1.99)

Application Number	29542318	29542318 - GAU: 2914
Filing Date	2015-10-13	
First Named Inventor	Jack Boys	
Art Unit	2914	
Examiner Name	T. C. Nelson	
Attorney Docket Number	56503-149126	

/T.N./	20	D667619	S	2012-09-25	Blakeslee
	21	D675003	S	2013-01-29	Leon et al.
	22	D684348	S	2013-06-18	Castellon
	23	D693553	S	2013-11-19	McClaskie
	24	D709676	S	2014-07-29	Jachini
	25	D725356	S	2015-03-31	Miner
	26	D730034	S	2015-05-26	Henderson
	27	D730035	S	2015-05-26	Henderson
	28	D740007	S	2015-10-06	Lan
	29	D747083	S	2016-01-12	Verfl

If you wish to add additional U.S. Patent citation information please click the Add button.

Add

U.S.PATENT APPLICATION PUBLICATIONS

Remove

**INFORMATION DISCLOSURE
STATEMENT BY APPLICANT**
(Not for submission under 37 CFR 1.99)

Application Number	29542318	29542318 - GAU: 2914
Filing Date	2015-10-13	
First Named Inventor	Jack Boys	
Art Unit	2914	
Examiner Name	T. C. Nelson	
Attorney Docket Number	56503-149126	

Examiner Initial*	Cite No	Publication Number	Kind Code ¹	Publication Date	Name of Patentee or Applicant of cited Document	Pages, Columns, Lines where Relevant Passages or Relevant Figures Appear
/T.N./	1	20050217140	A1	2005-10-06	Melis	
	2	20060048412	A1	2006-03-09	Kerrigan	
	3	20080141563	A1	2008-06-19	Meschan	
	4	20090045546	A1	2009-02-19	Schindler et al.	
	5	20110232130	A1	2011-09-29	BOUDREAU et al.	
	6	20130232821	A1	2013-09-12	Schindler et al.	
	7	20130247422	A1	2013-09-26	Holt et al.	
	8	20140305006	A1	2014-10-16	Azoulay	
	9	20150016021	A1	2015-01-15	Lane et al.	
	10	20150101215	A1	2015-04-16	Henderson et al.	

ALL REFERENCES CONSIDERED EXCEPT WHERE LINED THROUGH. /T.N./

**INFORMATION DISCLOSURE
STATEMENT BY APPLICANT**
(Not for submission under 37 CFR 1.99)

Application Number	29542318	29542318 - GAU: 2914
Filing Date	2015-10-13	
First Named Inventor	Jack Boys	
Art Unit	2914	
Examiner Name	T. C. Nelson	
Attorney Docket Number	56503-149126	

/T.N./	11	20150143722	A1	2015-05-28	Faggin et al.
--------	----	-------------	----	------------	---------------

If you wish to add additional U.S. Published Application citation information please click the Add button.

FOREIGN PATENT DOCUMENTS

Examiner Initial*	Cite No	Foreign Document Number ³	Country Code ² i	Kind Code ⁴	Publication Date	Name of Patentee or Applicant of cited Document	Pages, Columns, Lines where Relevant Passages or Relevant Figures Appear	T ⁵
	1							

If you wish to add additional Foreign Patent Document citation information please click the Add button.

NON-PATENT LITERATURE DOCUMENTS

Examiner Initials*	Cite No	Include name of the author (in CAPITAL LETTERS), title of the article (when appropriate), title of the item (book, magazine, journal, serial, symposium, catalog, etc), date, pages(s), volume-issue number(s), publisher, city and/or country where published.	T ⁵
	1		

If you wish to add additional non-patent literature document citation information please click the Add button.

EXAMINER SIGNATURE

Examiner Signature	/T. Chase Nelson/	Date Considered	07/27/2016
--------------------	-------------------	-----------------	------------

*EXAMINER: Initial if reference considered, whether or not citation is in conformance with MPEP 609. Draw line through a citation if not in conformance and not considered. Include copy of this form with next communication to applicant.

¹ See Kind Codes of USPTO Patent Documents at www.USPTO.GOV or MPEP 901.04. ² Enter office that issued the document, by the two-letter code (WIPO Standard ST.3). ³ For Japanese patent documents, the indication of the year of the reign of the Emperor must precede the serial number of the patent document. ⁴ Kind of document by the appropriate symbols as indicated on the document under WIPO Standard ST.16 if possible. ⁵ Applicant is to place a check mark here if English language translation is attached.

INFORMATION DISCLOSURE STATEMENT BY APPLICANT (Not for submission under 37 CFR 1.99)	Application Number	29542318	29542318 - GAU: 2914
	Filing Date	2015-10-13	
	First Named Inventor	Jack Boys	
	Art Unit	2914	
	Examiner Name	T. C. Nelson	
	Attorney Docket Number	56503-149126	

CERTIFICATION STATEMENT

Please see 37 CFR 1.97 and 1.98 to make the appropriate selection(s):

That each item of information contained in the information disclosure statement was first cited in any communication from a foreign patent office in a counterpart foreign application not more than three months prior to the filing of the information disclosure statement. See 37 CFR 1.97(e)(1).

OR

That no item of information contained in the information disclosure statement was cited in a communication from a foreign patent office in a counterpart foreign application, and, to the knowledge of the person signing the certification after making reasonable inquiry, no item of information contained in the information disclosure statement was known to any individual designated in 37 CFR 1.56(c) more than three months prior to the filing of the information disclosure statement. See 37 CFR 1.97(e)(2).

See attached certification statement.

- The fee set forth in 37 CFR 1.17 (p) has been submitted herewith.
- A certification statement is not submitted herewith.

SIGNATURE

A signature of the applicant or representative is required in accordance with CFR 1.33, 10.18. Please see CFR 1.4(d) for the form of the signature.

Signature	/Alan H. Norman/	Date (YYYY-MM-DD)	2016-07-19
Name/Print	Alan H. Norman	Registration Number	32285

This collection of information is required by 37 CFR 1.97 and 1.98. The information is required to obtain or retain a benefit by the public which is to file (and by the USPTO to process) an application. Confidentiality is governed by 35 U.S.C. 122 and 37 CFR 1.14. This collection is estimated to take 1 hour to complete, including gathering, preparing and submitting the completed application form to the USPTO. Time will vary depending upon the individual case. Any comments on the amount of time you require to complete this form and/or suggestions for reducing this burden, should be sent to the Chief Information Officer, U.S. Patent and Trademark Office, U.S. Department of Commerce, P.O. Box 1450, Alexandria, VA 22313-1450. **DO NOT SEND FEES OR COMPLETED FORMS TO THIS ADDRESS. SEND TO: Commissioner for Patents, P.O. Box 1450, Alexandria, VA 22313-1450.**

Privacy Act Statement

The Privacy Act of 1974 (P.L. 93-579) requires that you be given certain information in connection with your submission of the attached form related to a patent application or patent. Accordingly, pursuant to the requirements of the Act, please be advised that: (1) the general authority for the collection of this information is 35 U.S.C. 2(b)(2); (2) furnishing of the information solicited is voluntary; and (3) the principal purpose for which the information is used by the U.S. Patent and Trademark Office is to process and/or examine your submission related to a patent application or patent. If you do not furnish the requested information, the U.S. Patent and Trademark Office may not be able to process and/or examine your submission, which may result in termination of proceedings or abandonment of the application or expiration of the patent.

The information provided by you in this form will be subject to the following routine uses:

1. The information on this form will be treated confidentially to the extent allowed under the Freedom of Information Act (5 U.S.C. 552) and the Privacy Act (5 U.S.C. 552a). Records from this system of records may be disclosed to the Department of Justice to determine whether the Freedom of Information Act requires disclosure of these records.
2. A record from this system of records may be disclosed, as a routine use, in the course of presenting evidence to a court, magistrate, or administrative tribunal, including disclosures to opposing counsel in the course of settlement negotiations.
3. A record in this system of records may be disclosed, as a routine use, to a Member of Congress submitting a request involving an individual, to whom the record pertains, when the individual has requested assistance from the Member with respect to the subject matter of the record.
4. A record in this system of records may be disclosed, as a routine use, to a contractor of the Agency having need for the information in order to perform a contract. Recipients of information shall be required to comply with the requirements of the Privacy Act of 1974, as amended, pursuant to 5 U.S.C. 552a(m).
5. A record related to an International Application filed under the Patent Cooperation Treaty in this system of records may be disclosed, as a routine use, to the International Bureau of the World Intellectual Property Organization, pursuant to the Patent Cooperation Treaty.
6. A record in this system of records may be disclosed, as a routine use, to another federal agency for purposes of National Security review (35 U.S.C. 181) and for review pursuant to the Atomic Energy Act (42 U.S.C. 218(c)).
7. A record from this system of records may be disclosed, as a routine use, to the Administrator, General Services, or his/her designee, during an inspection of records conducted by GSA as part of that agency's responsibility to recommend improvements in records management practices and programs, under authority of 44 U.S.C. 2904 and 2906. Such disclosure shall be made in accordance with the GSA regulations governing inspection of records for this purpose, and any other relevant (i.e., GSA or Commerce) directive. Such disclosure shall not be used to make determinations about individuals.
8. A record from this system of records may be disclosed, as a routine use, to the public after either publication of the application pursuant to 35 U.S.C. 122(b) or issuance of a patent pursuant to 35 U.S.C. 151. Further, a record may be disclosed, subject to the limitations of 37 CFR 1.14, as a routine use, to the public if the record was filed in an application which became abandoned or in which the proceedings were terminated and which application is referenced by either a published application, an application open to public inspections or an issued patent.
9. A record from this system of records may be disclosed, as a routine use, to a Federal, State, or local law enforcement agency, if the USPTO becomes aware of a violation or potential violation of law or regulation.

Document Description: Issue Fee Payment (PTO-85B)

Issue Fee Transmittal Form

Application Number	Filing Date	First Named Inventor	Atty. Docket No.	Confirmation No.
29542318	13-Oct-2015	Jack Boys	56503-149126	7943

TITLE OF INVENTION :

Shoe Midsole

Entity Status	Application Type	Art Unit	Class - Subclass	EXAMINER
Regular Undiscounted	Design	2914	947000	THORNTON NELSON
Issue Fee Due	Publication Due	Total Fee(s) Due	Date Due	Prev. Paid Fee
\$560	\$0	\$560	21-Oct-2016	\$0

1.Change of Correspondence Address and/or Indication Of Fee Address (37 CFR 1.33 & 1.363)

Current Correspondence Address:	Current Indicated Fee Address :
21888 THOMPSON COBURN LLP ONE US BANK PLAZA SUITE 3500 ST LOUIS MO 63101 UNITED STATES 314-552-6000 IPDOCKET@THOMPSONCOBURN.COM	
<input type="checkbox"/> Change of correspondence address requested, system generated AIA/122-EFS form attached	<input type="checkbox"/> Fee Address indication requested, system generated SB/47-EFS form attached

2.Entity Status**Change in Entity Status**

Applicant certifying micro entity status; system generated Micro Entity certification form attached. See 37 CFR 1.29.

Note: Absent a valid certification of micro entity status, issue fee payment in the micro entity amount will not be accepted at the risk of application abandonment.
 If this box is checked, you will be prompted to choose a micro entity status on the gross income basis (37 CFR 1.29(a)) or the institution of higher education basis (37 CFR 1.29(d)), and make the applicable certification online.

Applicant asserting small entity status. See 37 CFR 1.27.

Note: If the application was previously under micro entity status, checking this box will be taken to be a notification of loss of entitlement to micro entity status.

Applicant changing to regular undiscounted fee status.

Note: Checking this box will be taken to be a notification of loss of entitlement to small or micro entity status, as applicable.

Document Description: Issue Fee Payment (PTO-85B)

3.The Following Fee(s) Are Submitted:

Issue Fee

I authorize USPTO to apply my previously paid issue fee to the current fees due

Publication Fee

The Director is hereby authorized to apply my previously paid issue fee to the current fee due and to charge deficient fees to Deposit Account Number _____

Advance Order - # of copies _____

If **in addition to** the payment of the issue fee amount submitted with this form, there are any discrepancies in any amount(s) due, the Director is authorized to charge any deficiency, or credit any overpayment, to Deposit Account Number _____.
The **issue fee must be submitted** with this form. **If payment of the issue fee does not accompany this form, checking this box and providing a deposit account number will NOT be effective to satisfy full payment of the fee(s) due.**

4.Firm and/or Attorney Names To Be Printed

NOTE: If no name is listed, no name will be printed

For printing on the patent front page, list to be displayed as entered

1. THOMPSON COBURN LLP

2. ALAN NORMAN

3.

5.Assignee Name(s) and Residence Data To Be Printed

PLEASE NOTE: Unless an assignee is identified below, no assignee data will appear on the patent. If an assignee is identified below, the document has been filed for recordation as set forth in 37 CFR 3.11. Completion of this form is NOT a substitute for filing an assignment.

Name	City	State	Country	Category
COLE HAAN LLC	NEW YORK	NEW YORK	united states	corporation

6.Signature

I certify, in accordance with 37 CFR 1.4(d)(4) that I am an attorney or agent registered to practice before the Patent and Trademark Office who has filed and has been granted power of attorney in this application. I also certify that this Fee(s) Transmittal form is being transmitted to the USPTO via EFS-WEB on the date indicated below.

Signature	/Alan H. Norman/	Date	09-01-2016
Name	Alan Norman	Registration Number	32285

Electronic Patent Application Fee Transmittal

Application Number:	29542318
Filing Date:	13-Oct-2015
Title of Invention:	Shoe Midsole
First Named Inventor/Applicant Name:	Jack Boys
Filer:	Alan Norman/Megan Remer
Attorney Docket Number:	56503-149126

Filed as Large Entity

Filing Fees for Design

Description	Fee Code	Quantity	Amount	Sub-Total in USD(\$)
Basic Filing:				
Design Issue Fee	1502	1	560	560
Publ. Fee- Early, Voluntary, or Normal	1504	1	0	0

Pages:

Claims:

Miscellaneous-Filing:

Petition:

Patent-Appeals-and-Interference:

Description	Fee Code	Quantity	Amount	Sub-Total in USD(\$)
Post-Allowance-and-Post-Issuance:				
Extension-of-Time:				
Miscellaneous:				
Total in USD (\$)				560

Electronic Acknowledgement Receipt

EFS ID:	26813382
Application Number:	29542318
International Application Number:	
Confirmation Number:	7943
Title of Invention:	Shoe Midsole
First Named Inventor/Applicant Name:	Jack Boys
Customer Number:	21888
Filer:	Alan Norman/Megan Remer
Filer Authorized By:	Alan Norman
Attorney Docket Number:	56503-149126
Receipt Date:	01-SEP-2016
Filing Date:	13-OCT-2015
Time Stamp:	14:13:26
Application Type:	Design

Payment information:

Submitted with Payment	yes
Payment Type	DA
Payment was successfully received in RAM	\$560
RAM confirmation Number	090216INTEFSW00000382200823
Deposit Account	200823
Authorized User	Megan Remer

The Director of the USPTO is hereby authorized to charge indicated fees and credit any overpayment as follows:

--	--	--	--	--	--

File Listing:

Document Number	Document Description	File Name	File Size(Bytes)/ Message Digest	Multi Part /.zip	Pages (if appl.)
1	Issue Fee Payment (PTO-85B)	Web85b.pdf	45902	no	2
			7a5f2d79490aa6f5642dd2c25f06244c942e2122		

Warnings:

Information:

2	Fee Worksheet (SB06)	fee-info.pdf	31705	no	2
			031d634f0b1bd57d412cc003b984e0fb36d3a501		

Warnings:

Information:

Total Files Size (in bytes):	77607
-------------------------------------	-------

This Acknowledgement Receipt evidences receipt on the noted date by the USPTO of the indicated documents, characterized by the applicant, and including page counts, where applicable. It serves as evidence of receipt similar to a Post Card, as described in MPEP 503.

New Applications Under 35 U.S.C. 111

If a new application is being filed and the application includes the necessary components for a filing date (see 37 CFR 1.53(b)-(d) and MPEP 506), a Filing Receipt (37 CFR 1.54) will be issued in due course and the date shown on this Acknowledgement Receipt will establish the filing date of the application.

National Stage of an International Application under 35 U.S.C. 371

If a timely submission to enter the national stage of an international application is compliant with the conditions of 35 U.S.C. 371 and other applicable requirements a Form PCT/DO/EO/903 indicating acceptance of the application as a national stage submission under 35 U.S.C. 371 will be issued in addition to the Filing Receipt, in due course.

New International Application Filed with the USPTO as a Receiving Office

If a new international application is being filed and the international application includes the necessary components for an international filing date (see PCT Article 11 and MPEP 1810), a Notification of the International Application Number and of the International Filing Date (Form PCT/RO/105) will be issued in due course, subject to prescriptions concerning national security, and the date shown on this Acknowledgement Receipt will establish the international filing date of the application.



APPLICATION NO.	ISSUE DATE	PATENT NO.	ATTORNEY DOCKET NO.	CONFIRMATION NO.
29/542,318	10/18/2016	D768969	56503-149126	7943

21888 7590 09/28/2016
THOMPSON COBURN LLP
ONE US BANK PLAZA
SUITE 3500
ST LOUIS, MO 63101

ISSUE NOTIFICATION

The projected patent number and issue date are specified above.

Determination of Patent Term Extension or Adjustment under 35 U.S.C. 154 (b)

Design patents have a term measured from the issue date of the patent and the term remains the same length regardless of the time that the application for the design patent was pending. Since the above-identified application is an application for a design patent, the patent is not eligible for Patent Term Extension or Adjustment under 35 U.S.C. 154(b).

Any questions regarding the Patent Term Extension or Adjustment determination should be directed to the Office of Patent Legal Administration at (571)-272-7702. Questions relating to issue and publication fee payments should be directed to the Application Assistance Unit (AAU) of the Office of Data Management (ODM) at (571)-272-4200.

APPLICANT(s) (Please see PAIR WEB site <http://pair.uspto.gov> for additional applicants):

Jack Boys, Greenland, NH;
Cole Haan LLC, New York, NY

The United States represents the largest, most dynamic marketplace in the world and is an unparalleled location for business investment, innovation, and commercialization of new technologies. The USA offers tremendous resources and advantages for those who invest and manufacture goods here. Through SelectUSA, our nation works to encourage and facilitate business investment. To learn more about why the USA is the best country in the world to develop technology, manufacture products, and grow your business, visit SelectUSA.gov.

SCORE Placeholder Sheet for IFW Content

Application Number: **29542318**

Issue Date: **10/18/2016**

The presence of this form in the IFW record indicates that the following document type was delivered in electronic format on the issue date identified above. This content is stored in the SCORE database.

- **Design Patent Grant**

To access the documents in the SCORE database, refer to instructions below.

At the time of document entry (noted above):

- Examiners may access SCORE content via the eDAN interface.
- Other USPTO employees can bookmark the current SCORE URL (<http://score.uspto.gov/ScoreAccessWeb/>).
- External customers may access SCORE content via the Public and Private PAIR interfaces.