

## **Exhibit 2029**

**UNITED STATES DISTRICT COURT  
SOUTHERN DISTRICT OF NEW YORK**

SHENZHEN NEEWER TECHNOLOGY CO., LTD.,

Plaintiff,

v.

ALLISMAN (SHENZHEN) TECHNOLOGY CO.,  
LTD. and SHENZHEN MAITEWEI INVESTMENT  
AND DEVELOPMENT CO., LTD.,

Defendants.

C.A. No. 20-CV-09446-KPF-DCF

**JURY TRIAL DEMANDED**

**COMPLAINT**

Plaintiff Shenzhen Neewer Technology Co., Ltd. (“Neewer” or “Plaintiff”), through its undersigned attorneys, files this Complaint against Defendants Shenzhen Maitewei Investment and Development Co., Ltd. (“Maitewei Investment”) and Allisman (Shenzhen) Technology Co., Ltd. (“Allisman”) (collectively, “Maitewei” or “Defendants”) and alleges as follows:

**NATURE OF THE ACTION**

1. Neewer brings this case against Maitewei Investment, the purported owner of U.S. Design Patent No. D881,980 (the “’980 patent”), and its subsidiary, alter ego, or otherwise related business entity, Allisman, the purported owner of U.S. Design Patent No. 901,054 (the “’054 patent”)<sup>1</sup>. On November 4, 2020—at the beginning of the busiest selling season of the year—an agent of Maitewei sent correspondence to Neewer, claiming that Neewer’s products infringe the ’980 patent directed to a softbox light and threatening to take “action” against Neewer if it did not contact Maitewei’s representative within 24 hours. Neewer contacted Maitewei within the

<sup>1</sup> The ’980 and ’054 patents are sometimes collectively referred to as the “Maitewei Patents.”

prescribed period. During ensuing discussions, Maitewei accused Neewer of also infringing the '054 patent directed to a ring light product and demanded that Neewer pay to license the Maitewei Patents. Because the parties could not reach resolution, Maitewei threatened to immediately commence takedown proceedings against many of Neewer's Amazon-listed products at the end of an in-person meeting between the parties on or around November 9, 2020. Thus, at any moment, Amazon can incorrectly remove (and Maitewei can improperly receive a *de facto* injunction against) Neewer's products. If Maitewei does take down Neewer's products, Neewer will suffer irreparable reputational harm and substantial damages. Neewer thus seeks a temporary restraining order and preliminary injunction preventing Maitewei from submitting takedown notices to Amazon concerning its softbox and ring light products.

2. Neewer also brings this action seeking a declaratory judgment that Neewer's products do not infringe the '980 patent or "the '054 patent, which are allegedly owned by Defendants. True and correct copies of the '980 patent and '054 patent are attached as Exhibits A and B. Neewer further seeks a declaratory judgment that the '980 patent and the '054 patent are each invalid.

3. In addition, Neewer brings this action for patent infringement concerning Maitewei's infringement of Neewer's U.S. Design Patent No. D887,590, titled *Ring Light* ("the '590 patent"). A true and correct copy of the '590 patent is attached as Exhibit C.

4. Accordingly, Neewer seeks permanent injunctive relief, an accounting, lost profits, compensatory and other damages, recovery of their costs and attorney's fees, and other applicable relief.

**THE PARTIES**

5. Plaintiff Neewer is a company organized under the laws of the People's Republic of China having a place of business at 15 Cotters Ln., East Brunswick, NJ 08816.

6. Upon information and belief, Maitewei Investment is a Chinese company having a place of business at B003, 2F, Building 4 (International Electronic City), No. 2070 Shennan Middle Road, Fuqiang Community, Huaqiang North Street, Futian District, Shenzhen, China.

7. Upon information and belief, Maitewei Investment owns, operates, or otherwise controls its subsidiary, alter ego or related business entity, Allisman. Upon information and belief, Allisman has a place of business at B001, 2F, Building 4 (International Electronic City), No. 2070 Shennan Middle Road, Fuqiang Community, Huaqiang North Street, Futian District, Shenzhen, China.

8. Upon information and belief, Maitewei also owns, operates, or otherwise controls the "Mount Dog" storefront on Amazon.com, and advertises its products under the "Mount Dog" brand name. Attached as Exhibit D is a true and correct copy of a printout of the "Mount Dog" Amazon storefront. In fact, Shenzhen Maitewei Investment and Development Co., Ltd. is named in the "About us" portion of the Mount Dog website and is listed as a party in the Privacy Policy on the Mount Dog Website. Attached as Exhibit E is a true and correct copy of a printout of the Mount Dog website; attached as Exhibit F is a true and correct copy of a printout of that website's privacy policy.

9. The business address listed on the "MountDog" storefront on Amazon.com is B001, 2F, Building 4 (International Electronic City), No. 2070 Shennan Middle Road, Fuqiang Community, Huaqiang North Street, Futian District, Shenzhen, China. A true and correct copy of the "MountDog" storefront listing this address is attached as Exhibit L.

10. Upon information and belief, Allisman owns the registered trademark for “MountDog.” Attached as Exhibit K is a true and correct copy of the assignment of the trademark registration for MountDog to Allisman.

### **JURISDICTION AND VENUE**

11. This is a civil action for declaratory judgment brought under the Declaratory Judgment Act, 28 U.S.C. §§ 2201 and 2202, and for patent infringement under the Patent Laws of the United States, Title 35 of the United States Code (35 U.S.C. §§ 100 *et seq.*). This Court has subject matter jurisdiction over the action pursuant to 28 U.S.C. §§ 1331 and 1338(a), as it involves claims arising under the Patent Laws of the United States including but not limited to 35 U.S.C. § 271.

12. This Court has personal jurisdiction over Maitewei in this District, because Maitewei has committed acts of patent infringement within this State and in this District, and has committed acts of patent infringement outside the State, which caused injury to Neewer within the State. Maitewei expected and should reasonably have expected such acts to have consequences in this State, and Maitewei derives substantial revenue from interstate or international commerce. Maitewei has offered for sale and/or sold over the Internet through at least their “Mount Dog” storefront, including in this District, ring light products that infringe the ’590 patent. Maitewei’s actions have caused injury to Neewer within this District.

13. Personal jurisdiction exists over Maitewei under at least New York’s long-arm statute, New York Civil Practice Law and Rules § 302. For example, Maitewei operates one or more interactive websites through which it sells or has sold to customers in the United States, including in this District, ring light products that infringe the ’590 patent. As an additional example, personal jurisdiction also exists over Maitewei because Maitewei has committed tortious

acts of intellectual property infringement outside New York State through at least the sale, marketing, advertisement, or offer for sale products that infringe the '590 patent, which has caused and continues to cause injury to Neewer within the State.

14. Venue is proper in this judicial district pursuant to 28 U.S.C. §§ 1391(b), 1391(c), and 1400(b).

### **FACTUAL BACKGROUND**

15. This paragraph incorporates by reference the concurrently-filed Declaration of Jun Wang as if fully set forth herein.

16. Neewer is in the business of at least selling and promoting high quality photography products including photography softbox products and ring light products. Neewer is one of the top sellers for photography softbox products and ring light products on Amazon.com (“Amazon”).

17. Upon information and belief, Neewer and Maitewei are competitors at least in the business of selling photography softbox products and ring light products.

18. Maitewei is listed as the assignee on the face of the '980 patent.

19. Allisman is listed as the assignee on the face of the '054 patent.

20. Upon information and belief, Maitewei strategically chose to wrongfully accuse Neewer of infringing the '980 patent during the peak sales season to inflict as much damage on Neewer business and reputation as possible.

21. Specifically, Maitewei accused the following softbox products of infringement during discussions with Neewer (*see* Exhibits G-1 to G-10, collectively, the “Neewer Softbox Products”):

- Neewer 700W Professional Photography 24x24 inches/60x60 Centimeters Softbox with E27 Socket Light Lighting Kit, offered for sale on Amazon with

an identification number of B017D7W57S. Attached as Exhibit G-1 is a true and correct copy of a printout of the Amazon webpage on which B017D7W57S is offered for sale;

- Neewer 2.6M x 3M/8.5ft x 10ft Background Support System and 800W 5500K Umbrellas Softbox Continuous Lighting Kit for Photo Studio Product,Portrait and Video Shoot Photography, offered for sale on Amazon with an identification number of B019GTCNXC. Attached as Exhibit G-2 is a true and correct copy of a printout of the Amazon webpage on which B019GTCNXC is offered for sale;
- Neewer 1350W Photography Continuous Softbox Lighting Kit 24x24 inches Professional Photo Studio Equipment with 2 Pieces E27 Socket 5500K Video Lighting Bulb for Filming Portraits Shoot, offered for sale on Amazon with an identification number of B07V466DVV. Attached as Exhibit G-3 is a true and correct copy of a printout of the Amazon webpage on which B07V466DVV is offered for sale;
- Neewer 3-Pack 2.4G LED Softbox Lighting Kit with Color Filter: 20"x28" Softbox, 3200-5600K 48W Dimmable LED Light Head with 2.4G Remote, Light Stand, Boom Arm, Bag for Photo Studio Video Shooting, offered for sale on Amazon with an identification number of B08FX5RFCV. Attached as Exhibit G-4 is a true and correct copy of a printout of the Amazon webpage on which B08FX5RFCV is offered for sale;
- Neewer Photography Backdrop Lighting Kit: 2.6Mx3M/8.5ftx10ft Background Support System 800W 5500K Umbrellas Softbox Continuous Lighting for

Portrait and Video Shoot Photography, offered for sale on Amazon with an identification number of B0869KWXMC. Attached as Exhibit G-5 is a true and correct copy of a printout of the Amazon webpage on which B0869KWXMC is offered for sale;

- Neewer 2-Pack 2.4G LED Softbox Lighting Kit with Color Filter: 20x28 Inch Softbox, 3200-5600K 48W Dimmable LED Light Head with 2.4G Remote, Light Stand, Red/Yellow/Blue Filter for Photo Studio Video, offered for sale on Amazon with an identification number of B08B87FR5F. Attached as Exhibit G-6 is a true and correct copy of a printout of the Amazon webpage on which B08B87FR5F is offered for sale;
- Neewer Upgraded 450W LED Photography Softbox Lighting Kit: (2) 24x24 Inches Softbox with E27 Socket and 5500K Instant Brightness Energy Saving LED Bulbs and Stand for Photo Studio Video Shooting, offered for sale on Amazon with an identification number of B083DKHVXG. Attached as Exhibit G-7 is a true and correct copy of a printout of the Amazon webpage on which B083DKHVXG is offered for sale;
- Neewer Photography Studio 600W Softbox Lighting Kit - 3 Packs 24x24 inches Softbox with 45W Fluorescent Light Bulb, Light Stands, Boom Arm and Sandbag for Portraits Video Shooting, offered for sale on Amazon with an identification number of B07DHFTX3H. Attached as Exhibit G-8 is a true and correct copy of a printout of the Amazon webpage on which B07DHFTX3H is offered for sale;

- Neewer Complete Photography Lighting Kit: 8.5x10feet Background Support System/800W 5500K Umbrellas Softbox Continuous Lighting Kit/5-in-1 Reflector Disc/Tripod/Phone Holder/Carry Bag for Studio, offered for sale on Amazon with an identification number of B07VCR2ZB2. Attached as Exhibit G-9 is a true and correct copy of a printout of the Amazon webpage on which B07VCR2ZB2 is offered for sale; and
- Neewer Photography Bi-color Dimmable LED Softbox Lighting Kit:20x27 inches Studio Softbox, 45W Dimmable LED Light Head with 2 Color Temperature and Light Stand for Photo Studio Portrait,Video Shooting, offered for sale on Amazon with an identification number of B07C27QB1G. Attached as Exhibit G-10 is a true and correct copy of a printout of the Amazon webpage on which B07C27QB1G is offered for sale.

22. Maitewei also wrongfully accused Neewer of infringing the '054 patent based on its sales of ring light products such as the following products identified by Amazon product identification number (*see* Exhibits H-1 to H-11, collectively, “Neewer Ring Light Products” and together with the Neewer Softbox Products, the “Accused Products”):

- Neewer Ring Light Kit:18"/48cm Outer 55W 5500K Dimmable LED Ring Light, Light Stand, Carrying Bag for Camera, Smartphone, YouTube, TikTok, Self-Portrait Shooting, Black, Model:10088612, offered for sale on Amazon with an identification number of B01LXDNNBW. Attached as Exhibit H-1 is a true and correct copy of a printout of the Amazon webpage on which B01LXDNNBW is offered for sale;

- Neewer 18-inch SMD LED Ring Light Dimmable Lighting Kit with 78.7-inch Light Stand, Filter and Hot Shoe Adapter for Photo Studio LED Lighting Portrait YouTube TikTok Video Shooting (No Carrying Bag), offered for sale on Amazon with an identification number of B0784SSRZS. Attached as Exhibit H-2 is a true and correct copy of a printout of the Amazon webpage on which B0784SSRZS is offered for sale;
- Neewer 18-inch White LED Ring Light with Silver Light Stand Lighting Kit Dimmable 42W 3200-5600K with Soft Filter, Hot Shoe Adapter, Cellphone Holder for Make-up Video Shooting, offered for sale on Amazon with an identification number of B07GKQGLY8. Attached as Exhibit H-3 is a true and correct copy of a printout of the Amazon webpage on which B07GKQGLY8 is offered for sale;
- Neewer Camera Photo/Video 18 inches/48 Centimeters Outer 55W 240 Pieces LED SMD Ring Light 5500K Dimmable Ring Video Light with Plastic Color Filter Set and Universal Adapter with US/EU Plug, offered for sale on Amazon with an identification number of B00ZL177PO. Attached as Exhibit H-4 is a true and correct copy of a printout of the Amazon webpage on which B00ZL177PO is offered for sale;
- Neewer 20-inch LED Ring Light Kit for Makeup Youtube Video Blogger Salon - Adjustable Color Temperature with Battery or DC Power Option, Battery, Charger, AC Adapter, Phone Clamp and Stand Included, offered for sale on Amazon with an identification number of B07KWYH27B. Attached as Exhibit

H-5 is a true and correct copy of a printout of the Amazon webpage on which B07KWYH27B is offered for sale;

- Neewer Advanced 18-inch LED Ring Light Support Manual Touch Control with LCD Screen, 2.4G Remote and Multiple Lights Control, 3200-5600K, Stand Included for Makeup YouTube Video Blogger Salon (Black), offered for sale on Amazon with an identification number of B07ZF5V9LZ. Attached as Exhibit H-6 is a true and correct copy of a printout of the Amazon webpage on which B07ZF5V9LZ is offered for sale;
- Neewer RL-12 LED Ring Light 14" outer/12 on Center with Light Stand, Soft Tube, Filter, Carrying Bag for Makeup, YouTube, TikTok, Camera/Phone Video Shooting, offered for sale on Amazon with an identification number of B01JIBWCX4. Attached as Exhibit H-7 is a true and correct copy of a printout of the Amazon webpage on which B01JIBWCX4 is offered for sale;
- Neewer Upgraded 18-inch Outer Dimmable SMD LED Ring Light with 79-inch Stand, Bluetooth Receiver, Rotatable Phone Holder for Smartphone/Camera Make up YouTube Video Shooting (EU/US Plug, Bag Included), offered for sale on Amazon with an identification number of B078JLZ3X9. Attached as Exhibit H-8 is a true and correct copy of a printout of the Amazon webpage on which B078JLZ3X9 is offered for sale;
- Neewer 18"/48cm LED Ring Light: 52W Dimmable LED Ringlight Makeup Selfie Light Ring with Stand/Soft Tube/Phone Holder/Filter for Camera Phone Photography YouTube TikTok Video Blogging Live Streaming, offered for sale on Amazon with an identification number of B08DNKR4TV. Attached as

Exhibit H-9 is a true and correct copy of a printout of the Amazon webpage on which B08DNKR4TV is offered for sale;

- Neewer LED Ring Light 18-inch Outer Diameter with Top/Bottom Dual Hot Shoe, Mirror, Smartphone Holder, Light Stand, Soft Tube, Color Filter for Makeup Facial Beauty Portrait Video Shooting (US Plug), offered for sale on Amazon with an identification number of B07F252MH2. Attached as Exhibit H-10 is a true and correct copy of a printout of the Amazon webpage on which B07F252MH2 is offered for sale; and
- Neewer Ring Light with Stand Kit: 18-inch Outer 55W Dimmable LED Ring Light with Soft Diffuser, Filter, Stand, Soft Tube, Phone Holder and Carrying Bag for YouTube Video, Selfie Light, Makeup, etc., offered for sale on Amazon with an identification number of B07CJDD3NL. Attached as Exhibit H-11 is a true and correct copy of a printout of the Amazon webpage on which B07CJDD3NL is offered for sale.

23. Maitewei requested a meeting with Neewer on November 9, 2020, during which Maitewei demanded payment of a license fee based on the alleged infringement of the '980 patent and the '054 patent by the Neewer Softbox Products and the Neewer Ring Light Products. At that meeting, Maitewei further threatened to file takedown notices with Amazon to delist the Accused Products if Neewer refused to pay the license fee.

24. However, Neewer's products do not infringe the '980 patent or the '054 patent.

25. For example, Neewer's products differ significantly in at least three respects from the claim of the '980 Patent—(1) the shape of the softbox is different; (2) the assembly used to angle the softbox is different; and (3) the lightbulb assembly is a different design. Taken together,

a purchaser familiar with existing softbox products would not be deceived into purchasing Neewer's product supposing it to be a softbox embodying the claimed design.

26. In addition, both the '980 patent and the '054 patent are invalid in view of Neewer's photography products, which have been publicly disclosed, offered for sale, and used prior to the priority dates of the patents.

27. For example, at least one of the Neewer Softbox Products (B017D7W57S) was available for sale on Amazon as of October 30, 2015. *See* Exhibit G-1. However, the '980 patent was not issued until April 21, 2020 and it claims a priority date of December 19, 2019.

28. As a further example, at least one of the Neewer Ring Light Products (B01LXDNNBW) was available for sale on Amazon as of September 30, 2016. *See* Exhibit H-1. However, the '054 patent was not issued until November 3, 2020 and it claims a priority date of May 29, 2020.

29. As yet another example, at least one of Maitewei's softbox lighting products, marketed as "MOUNTDOG Softbox Lighting Kit Photography Studio Light 20"x28" Professional Continuous Light System with E27 95W Bulbs 5500K Photo Equipment for Filming Model Portraits Advertising Shooting" with an identification number of B07G32T189 (the "Maitewei Softbox Product") was available for sale on Amazon as of September 11, 2018, which is more than one year before the December 19, 2019 filing date of the '980 patent. Attached as Exhibit I is a true and correct copy of a printout of the Amazon webpage on which B07G32T189 is offered for sale.

30. Therefore, the '980 patent and the '054 patent are each invalid at least because of the prior public use and sale of at least one of the Neewer Softbox Products and at least one of the Neewer Ring Light Products and the Maitewei Softbox Product. In addition, the '980 patent and

the '054 patent each fails to satisfy one or more of the conditions and requirements for patentability set forth in Title 35 of the United States Code including, but not limited to, 35 U.S.C. §§ 101, 102, 103, 112 and/or 171, and the rules, regulations, and law pertaining thereto.

31. Neewer plans and intends to continue to at least sell, and promote its photography products including the Accused Products. However, as discussed above, Maitewei has demonstrated its intent to enforce the '980 patent and the '054 patent. Neewer is thus under a reasonable apprehension that Neewer, its customers, retailers, and/or distributors will be sued by Maitewei and/or will be the subject of baseless takedown notices for the alleged infringement by the Accused Products.

32. Accordingly, for at least the reasons set forth above, an actual and justiciable controversy has arisen and exists between the parties as to the validity of the '980 patent and the '054 patent and as to the alleged infringement by making, importing, and selling Neewer's photography products including the Accused Products.

33. Moreover, Maitewei's making, using, sale, and/or offer for sale of one or more of its ring light products infringe(s) Neewer's '590 patent.

34. Specifically, Neewer invented a new, original, and ornamental design directed to ring light, as shown and described in the '590 patent. The '590 patent was issued on June 16, 2020 and claims a priority date of July 5, 2018.



35. Maitewei has infringed the '590 patent by, for example, selling and offering for sale a ring light product marketed as "MOUNTDOG 18" Ring Light Kit 55W Bluetooth LED Ringlight Lighting with Tripod Stand Dimmable 3200K/5500K YouTube Circle Lighting Ringlights for Makeup Video Photography Blogging Portrait" on Amazon, with an identification number of B07L6B667Q (the "Maitewei Ring Light Product"). Attached as Exhibit J is a true and correct

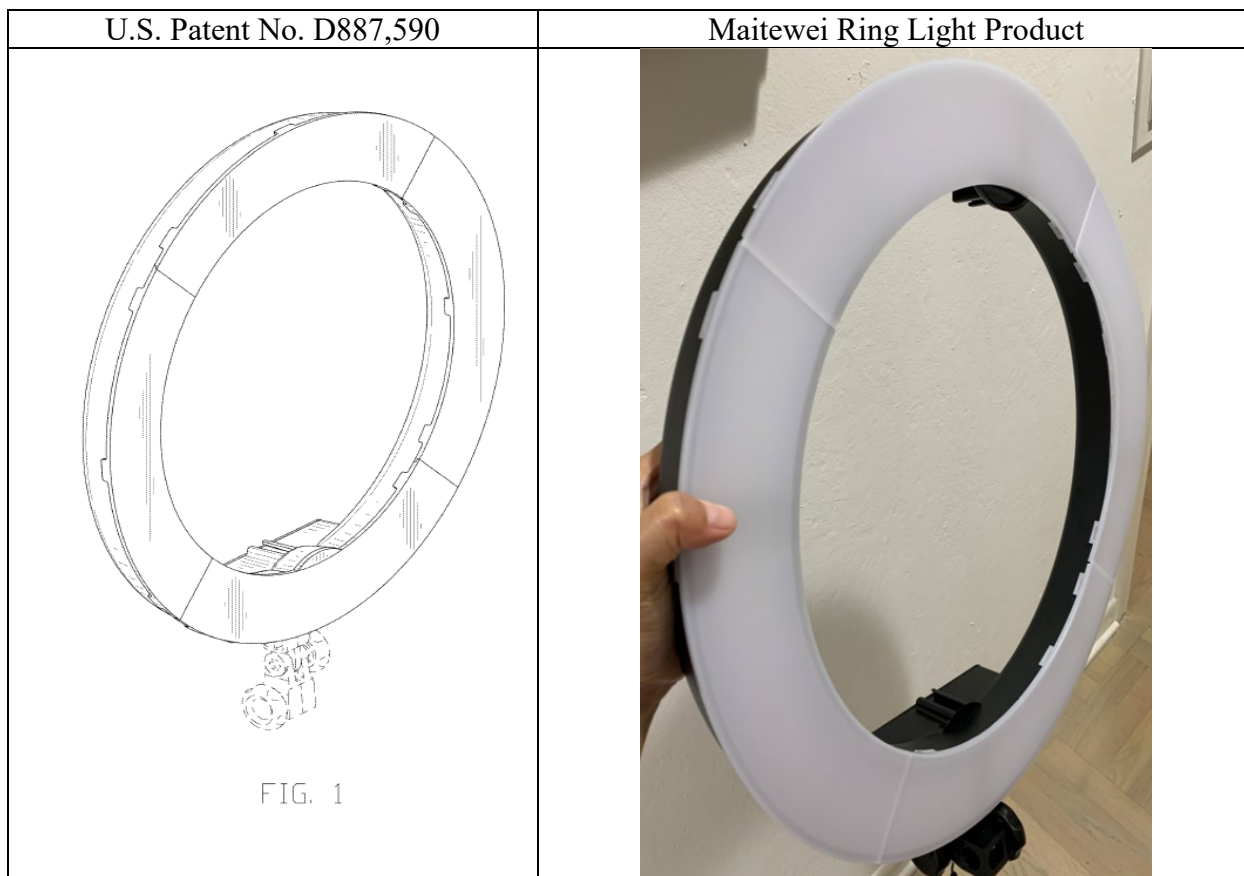



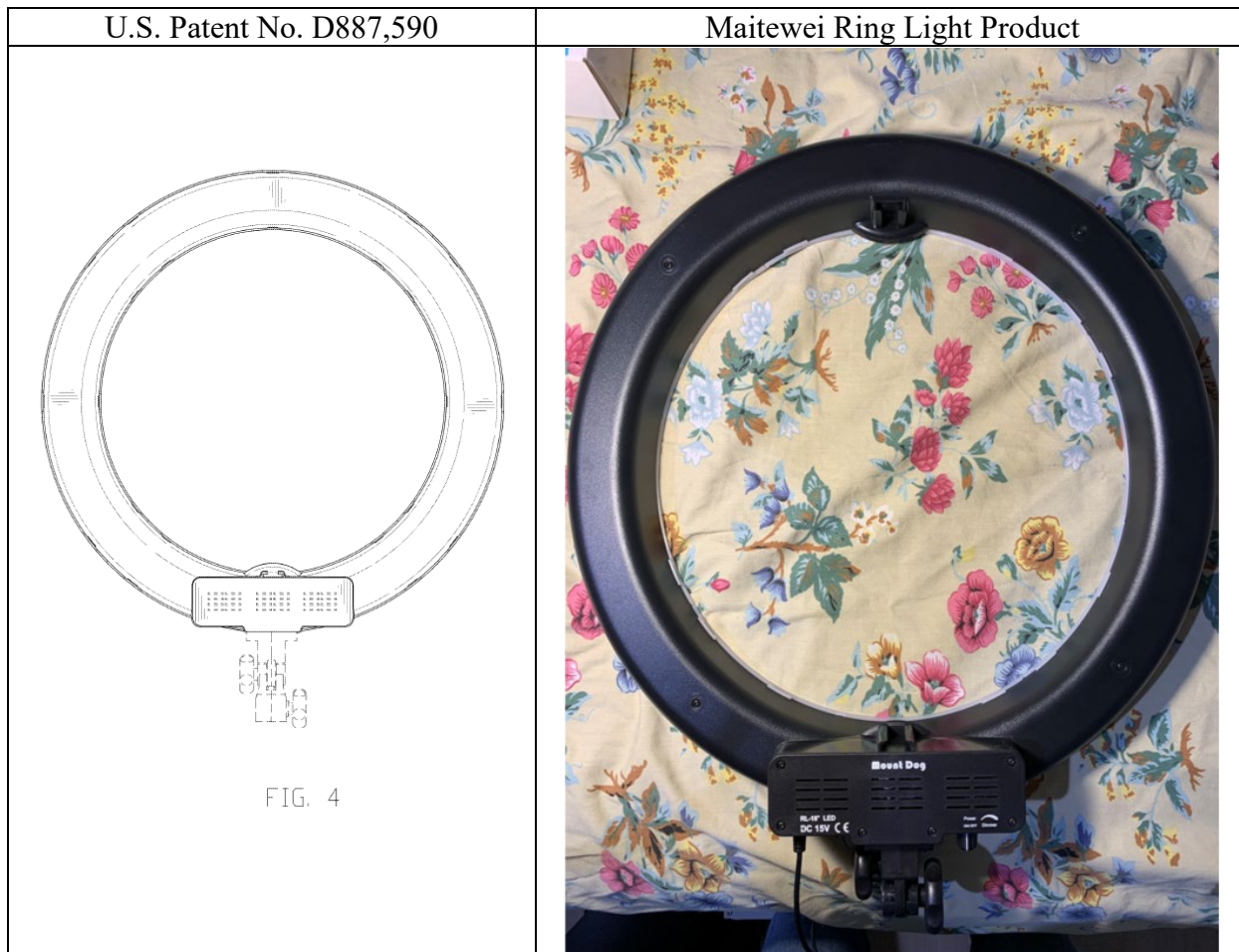

copy of a printout of the Amazon webpage on which B07L6B667Q is offered for sale. Below is a side-by-side comparison of the '590 patent and the Maitewei Ring Light Product:



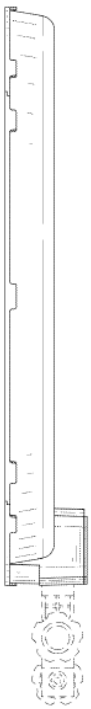

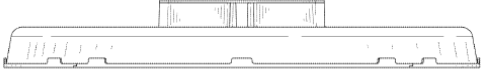
U.S. Patent No. D887,590	Maitewei Ring Light Product
 <p data-bbox="428 930 516 961">FIG. 2</p>	
 <p data-bbox="428 1619 516 1650">FIG. 3</p>	

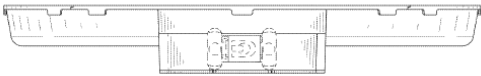

U.S. Patent No. D887,590	Maitewei Ring Light Product
 <p data-bbox="440 1052 542 1087">FIG. 5</p>	

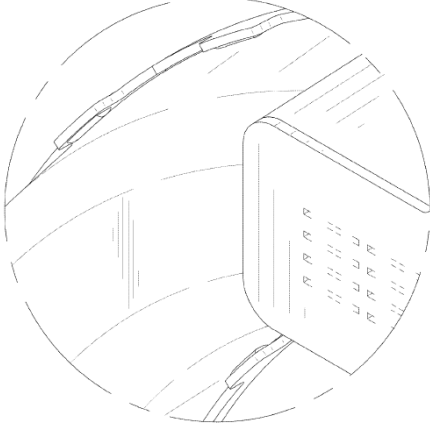
U.S. Patent No. D887,590	Maitewei Ring Light Product
 <p data-bbox="391 1045 488 1081">FIG. 6</p>	
 <p data-bbox="410 1371 488 1407">FIG. 7</p>	
 <p data-bbox="435 1633 513 1669">FIG. 8</p>	

U.S. Patent No. D887,590	Maitewei Ring Light Product
 <p data-bbox="446 716 505 743">FIG. 9</p>	

36. As illustrated above, the Maitewei Ring Light Product contains each and every feature claimed by the '590 patent. However, Neewer has never licensed the '590 patent to Maitewei, and Maitewei has no right, title or interest in or to the '590 patent.

37. Upon information and belief, Maitewei did not publicly disclose or make the Maitewei Ring Light Product available for sale until December 6, 2018. *See* Exhibit J.

38. Based on the foregoing, an actual and justiciable controversy now exists between Neewer and ALSM regarding ALSM's infringement of the '590 patent, which warrants the issuance of a declaratory judgment.

#### **COUNT I – DECLARATION OF NON-INFRINGEMENT OF THE '980 PATENT**

39. Neewer repeats and incorporates by reference its allegations in each of the foregoing paragraphs as if fully set forth herein.

40. Neewer has not infringed and does not infringe the '980 patent directly or indirectly, either literally or under the doctrine of equivalents, by making, importing, or selling the Neewer Softbox Products, for at least the reasons set forth above.

41. There is an actual controversy, within the meaning of 28 U.S.C. § 2201 and § 2202, between Neewer and Maitewei concerning the non-infringement of the '980 patent.

42. Neewer is therefore entitled to a declaratory judgment that it has not infringed the '980 patent, directly or indirectly, either literally or under the doctrine of equivalents.

**COUNT II – DECLARATION OF NON-INFRINGEMENT OF THE '054 PATENT**

43. Neewer repeats and incorporates by reference its allegations in each of the foregoing paragraphs as if fully set forth herein.

44. Neewer has not infringed and does not infringe the '054 patent directly or indirectly, either literally or under the doctrine of equivalents, by making, importing, or selling the Neewer Ring Light Products, for at least the reasons set forth above.

45. There is an actual controversy, within the meaning of 28 U.S.C. § 2201 and § 2202, between Neewer and Maitewei concerning the non-infringement of the '054 patent.

46. Neewer is therefore entitled to a declaratory judgment that it has not infringed the '054 patent, directly or indirectly, either literally or under the doctrine of equivalents.

**COUNT III – DECLARATION OF INVALIDITY OF THE '980 PATENT**

47. Neewer repeats and incorporates by reference its allegations in each of the foregoing paragraphs as if fully set forth herein.

48. As set forth above, the design purportedly claimed in the '980 patent does not qualify for patent protection. For example, and without limitation, the '980 patent is invalid as anticipated and/or obvious in view of the prior public use and sale of at least one of the Neewer Softbox Products and the Maitewei Softbox Product.

49. An actual controversy exists between Neewer and Maitewei regarding whether or not the '980 patent is invalid.

50. Neewer seeks and is entitled to a declaratory judgment that the '980 patent is invalid and void for failure to satisfy one or more conditions of patentability set forth in 35 U.S.C. §§ 101, 102, 103, 112 and/or 171. Without such declaratory relief, Neewer will be irreparably harmed and damaged.

**COUNT IV – DECLARATION OF INVALIDITY OF THE '054 PATENT**

51. Neewer repeats and incorporates by reference its allegations in each of the foregoing paragraphs as if fully set forth herein.

52. As set forth above, the design purportedly claimed in the '054 patent does not qualify for patent protection. For example, and without limitation, the '054 patent is invalid as anticipated and/or obvious in view of the prior public use and sale of at least one of the Neewer Ring Light Products.

53. An actual controversy exists between Neewer and Maitewei regarding whether or not the '054 patent is invalid.

54. Neewer seeks and is entitled to a declaratory judgment that the '054 patent is invalid and void for failure to satisfy one or more conditions of patentability set forth in 35 U.S.C. §§ 101, 102, 103, 112 and/or 171. Without such declaratory relief, Neewer will be irreparably harmed and damaged.

**COUNT V – INFRINGEMENT OF THE '590 PATENT**

55. Neewer repeats and incorporates by reference its allegations in each of the foregoing paragraphs as if fully set forth herein.

56. The '590 patent is non-anticipated and non-obvious as defined in 35 U.S.C. §§ 102 and 103.

57. Maitewei has made, used, imported, supplied, distributed, sold, and/or offered for sale one or more of its ring light products including the Maitewei Ring Light Product described above. By so doing, Maitewei has directly infringed (literally and/or under the doctrine of equivalents) the '590 patent. Maitewei's infringement in this regard is ongoing.

58. Neewer has been damaged as a result of Maitewei's infringing conduct, and Maitewei is liable to Neewer in an amount that adequately compensates it for such infringements, which, by law, cannot be less than a reasonable royalty, together with interest and costs as fixed by the Court under 35 U.S.C. § 284. In the alternative, Maitewei is liable to Neewer under 35 U.S.C. § 289 in the amount of the total profits that Maitewei has made from the infringing products.

59. Upon information and belief, Maitewei's infringement is willful and intentional.

60. The willful and intentional nature of Maitewei's infringement entitles Neewer to an award of treble damages pursuant to 35 U.S.C. § 284 and the exceptional nature of the case entitles Neewer to an award of its attorneys' fees pursuant to 35 U.S.C. § 285.

61. Neewer will continue to suffer damages and irreparable harm unless Maitewei is restrained and enjoined by this court, pursuant to 35 U.S.C. § 283 from further infringement of the patents.

**PLAINTIFF'S PRAYER FOR RELIEF**

Wherefore, Neewer respectfully requests that this Court enter judgment in its favor and grant the following relief:

(a) A declaration that Neewer has not infringed, induced infringement of, or contributorily infringed, and does not infringe, induce infringement of, and/or contributorily infringe the '980 patent or the '054 patent;

(b) A declaration that the '980 patent and the '054 patent are each invalid and void for failure to comply with one or more sections of Title 35 of the United States Code including, without limitation, 35 U.S.C. §§ 101, 102, 103, 112 and/or 171;

(c) A declaration that Maitewei has no claim for damages from the alleged infringement of the '980 patent or the '054 patent;

(d) A preliminary and permanent injunction enjoining Maitewei from directly or indirectly asserting or instituting any action based on the '980 patent or the '054 patent against Neewer or any of its customers, retailers, or partnered distributors, including precluding Maitewei from filing any takedown notices or other infringement reports with Amazon against Neewer's products with respect to the '980 patent or the '054 patent;

(e) Adjudging that Maitewei has infringed the '590 patent;

(f) Awarding Neewer damages against Maitewei in an amount adequate to compensate Neewer for Maitewei's infringement under 35 U.S.C. § 284 or, in the alternative, in the amount of the total profits that Maitewei has made from the infringing products under 35 U.S.C. § 289, together with interest and costs;

(g) Awarding Neewer an additional sum on account of the willful, intentional and deliberate character of Maitewei's infringing acts pursuant to 35 U.S.C. § 284;

(h) Adjudging that this case is exceptional pursuant to 35 U.S.C. § 285 and awarding Neewer reasonable attorney fees and costs against Maitewei;

(i) A preliminary and permanent injunction enjoining Maitewei from making, selling, or importing any products that infringe the '590 patent including the Maitewei Ring Light Product;

(j) Such other and further relief as the Court may deem just and proper.

**JURY DEMAND**

Pursuant to Rule 38(b) of the Federal Rules of Civil Procedure, Neewer demands a trial by jury as to all issues and claims so triable.

Dated: November 10, 2020

Respectfully submitted,

GREENBERG TRAURIG, LLP

By: /s/ Jonathan D. Ball

Jonathan D. Ball  
200 Park Avenue  
New York, NY 10166  
Tel.: (212) 801-9200  
[ballj@gtlaw.com](mailto:ballj@gtlaw.com)

*Attorney for Plaintiff Shenzhen Neewer  
Technology Co. Ltd.*

# Exhibit H-5

Discover holiday gifts Home Electronics Toys Shopall

Electronics > Camera & Photo > Flashes > Macro & Ringlight Flashes



Roll over image to zoom in

### Neewer 20-inch LED Ring Light Kit for Makeup Youtube Video Blogger Salon - Adjustable Color Temperature with Battery or DC Power Option, Battery, Charger, AC Adapter, Phone Clamp and Stand Included

Visit the Neewer Store  
 4.5 stars (1,035 ratings) | 46 answered questions  
 Amazon's Choice for "larger ring light"

Price: **\$135.99** & FREE Shipping. Details & FREE Returns  
 Coupon Save an extra \$10.00 when you apply this coupon. Details

Get \$60 off instantly: Pay \$75.99 upon approval for the Amazon Rewards Visa Card.

Available at a lower price from other sellers that may not offer free Prime shipping.

Size: 20 inches

18 inch \$112.99	20 inch-White \$119.99	20 inches <b>\$135.99</b>
---------------------	---------------------------	------------------------------

- KIT INCLUDES: (1) 20-inch SMD LED Ring Light, (1) Light Stand, (1) Ball Head Adapter, (2) Li-ion Battery, (1) USB Battery Charger, (1) Rotatable Phone Holder, (1) DC Power Adapter, (1) Remote; (1) Carrying Case ONLY for Ring Light; Note: Camera and Smart phone are NOT included
- 20" 44W LED RING LIGHT: This is an ENLARGED NEEWER Ring Light designed with 20" diameter and 352 pieces energy-saving SMD LED beads; Ring shape renders a beautiful catch light in the eyes of the subject that make the eyes bright and sparkling. Color temperature (3200k to 5600k) and brightness can be adjusted easily by separate control knob
- 2 POWER OPTIONS: Support DC power adapter or Sony NP-F550/F970 replacement Li-ion Battery; 2 Li-ion batteries and 1 USB charger included offer great convenience for wireless/outdoor operation. [PLEASE NOTE: Power will be lower about 10W when using battery and it can work about 48 minutes when batteries are fully charged]
- COMPLETE ACCESSORIES: Pro heavy duty metal light stand with adjustable height 36-79 inches/92-200 centimeters; Ball head adapter can connect camera/phone holder with ring light; 360 degree rotatable smartphone holder support portrait mode (vertical) or landscape mode (horizontal); Also comes with a durable carrying case ONLY for ring light
- VARIOUS APPLICATIONS: It is suitable for light filling of varieties of scenes. Ideal for personal makeup, makeup tutorials, portrait photography, live show, video chat, YouTube video shooting, live broadcast, fashion display, product display, tattoo artist, hair salon, beauty shop etc

Compare with similar items  
 New & Used (12) from \$119.04 + FREE Shipping

#### Consider this Amazon's Choice product that delivers quickly

Amazon's Choice

**IVISII 19 inch Ring Light with Remote Controller and Stand iPad Holder, 60W Bi-Color with 4 Color Soft Filters for Live Stream/Makeup/YouTube Video/TikTok/Zoom/Photography**  
 \$159.99 vprime  
 4.5 stars (1084)

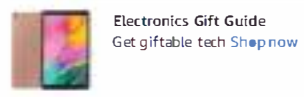

#### Frequently bought together

Total price: **\$191.68**  
 Add all three to Cart  
 Add all three to List

- These items are shipped from and sold by different sellers. Show details
- ✓ This item: Neewer 20-inch LED Ring Light Kit for Makeup Youtube Video Blogger Salon - Adjustable Color... \$135.99
- ✓ Julius Studio Premium Photo & Video 10 ft Wide Backdrop Stand (119 x 86 inch) Background Support... \$47.90
- ✓ Cheaplights - Heavy Duty Muslin Clamps 4 1/2 inch 6 Pack \$7.79

#### Products related to this item



**\$135.99**  
 & FREE Shipping. Details  
 & FREE Returns

Arrives: Wednesday, Nov 18  
 Details  
 Fastest delivery: Thursday, Nov 12  
 Order within 9 hrs and 17 mins  
 Details

In Stock.  
 Add to Cart  
 Buy Now

Secure transaction  
 Ships from Amazon  
 Sold by iphotox

prime  
 Enjoy fast, FREE delivery, exclusive deals and award-winning movies & TV shows with Prime  
 Try Prime and start saving today with Fast, FREE Delivery

- Add an Accessory:
- Adobe Creative Cloud Photography Plan 20 GB (Photo... \$9.99
  - Adobe Creative Cloud | Entire collection of Adobe... \$79.49
  - Adobe Photoshop | Photo, Image, and Design Editing... \$31.49
  - Samsung (MB-ME128GA/AM) 128GB 100MB/s (U3) MicroSD... \$28.99
- Add gift options  
 Select delivery location  
 Add to List

New & Used (12) from \$119.04 + FREE Shipping

Share

- Other Sellers on Amazon
- \$136.99** Add to Cart  
 & FREE Shipping on eligible orders  
 Details  
 Sold by Midgar's Best
  - \$138.99** Add to Cart  
 & FREE Shipping on eligible orders.  
 Details  
 Sold by KinoldGlobalTrade (USA)
  - \$139.99** Add to Cart  
 & FREE Shipping on eligible orders.  
 Details

**\$138.99**  
 FREE Shipping on eligible orders.  
 Details  
 Sold by: KinoidGlobalTrade (USA)  
**\$139.99** [Add to Cart](#)  
 & FREE Shipping on eligible orders.  
 Details  
 Sold by: vividHWUS

**Products related to this item**

Page 1 of 63

Sponsored

 <b>Neewer Ring Light Kit: 18"/48cm Outer 55W 5500K Dimmable LED Ring Light, Light Stand...</b> ★★★★★ 21,590 <b>\$97.99</b> ✓prime	 <b>Neewer Upgraded 18-inch Ring Light Metal Video Lighting Kit: 42W 3200-5600K Light R...</b> ★★★★★ 6 <b>\$139.99</b> ✓prime	 <b>Ring Light 19 inch LED Outer Adjustable Color Temperature 3000-5800K with Stand, di...</b> ★★★★★ 32 <b>\$89.99</b> ✓prime	 <b>Ring Light with Stand for iPad and Remote Control 19" Make up Bi-Color 3000K5800K...</b> ★★★★★ 13 <b>\$149.99</b> ✓prime	 <b>10" Selfie Ring Light, YUNLIGHTS 26 Colors RGB Ring Light with 2 Adjustable Tripod...</b> ★★★★★ 14 <b>\$43.99</b> ✓prime	 <b>18" LED Ring Light with Stand, Wireless Remote Control LCD Screen with Phone Holde...</b> ★★★★★ 134 <b>\$89.97</b> ✓prime
--	---	---	--	--	---

**Inspired by your recent shopping trends**

Page 1 of 14

 <b>Neewer Camera Photo/Video 18 inches/48 Centimeters Outer 55W 240 Pieces...</b> ★★★★★ 841 <b>\$76.99</b>	 <b>Neewer 18-inch White LED Ring Light with Silver Light Stand Lighting Kit Dimmable...</b> ★★★★★ 398 <b>\$134.99</b> Only 11 left in stock - orde...	 <b>Neewer Camera Photo/Video LED Ring Light 18 inches/48 Centimeters Outer...</b> ★★★★★ 256 <b>\$73.99</b>	 <b>Neewer 18-inch SMD LED Ring Light Dimmable Lighting Kit with 78.7-inch Light...</b> ★★★★★ 5,682 <b>\$81.99</b>	 <b>Neewer Ring Light Kit [Upgraded Version-1.8cm Ultra Slim]-18 inches,3200...</b> ★★★★★ 350 <b>\$99.99</b>	 <b>Neewer Upgraded 18-inch Ring Light Silver Metal Lighting Kit: 42W 3200-5600K Ring...</b> ★★★★★ 94 <b>\$138.99</b> Only 15 left in stock - orde...	 <b>Neewer RL-12 LED Ring Light 14" outer/12 on Center with Light Stand, Soft Tube, Filter...</b> ★★★★★ 5,214 <b>\$69.99</b>
---	---	---	--	--	--	--

**Special offers and product promotions**

- **Amazon Business** : For business only pricing, quantity discounts and FREE Shipping. [Register a free business account](#)
- Your cost could be **\$125.99** instead of **\$135.99!** Get **\$10.00** off instantly as a gift card upon approval for the **Amazon.com Store Card**. [Learn more.](#)

**Have a question?**

Find answer in product info, Q&As, reviews

**From the manufacturer**



**20" LED RING LIGHT KIT**  
**44W DIMMABLE**  
**352 Pieces LEDs / 2 Power Options**



**Neewer Upgraded 20-inch LED Ring Light Kit for Portrait Photography Video Make-up Selfie Live Streaming Hair Salon, etc**

**Kit Includes:** (1)20-inch LED Ring Light, (1)Light Stand, (1)Ball Head Adapter, (2)Li-ion Battery, (1)USB Battery Charger, (1)Rotatable Phone Holder, (1)DC Power Adapter, (1)Remote; (1)Carrying Case

- It is designed with 20-inch diameter and 352 pieces energy-saving SMD LED beads to provide more filling light
- It supports 2 power options: DC power adapter or NP-F550/970 replacement Li-ion batteries, so it is perfect to use in indoor and outdoor portrait photography, live show,

**NEEWER**

Pro Quality, Amateur Prices

Neewer - Help You Build a Audio & Video World with Innovation  
 With multiple locations over three continents, Neewer focuses on photography, video, and music equipment. We are committed to offering professional premium products to photographers, videographers, music lovers all over the world. We have listened to our



- It is designed with 20-inch diameter and 352 pieces energy-saving SMD LED beads to provide more filling light
- It supports 2 power options: DC power adapter or NP-FS50/970 replacement Li-ion batteries, so it is perfect to use in indoor and outdoor portrait photography, live show, YouTube video shooting, live streaming, make up artists, etc.
- Please Note: Power will be lower about 10W when using battery and it can work about 48 minutes when batteries are fully charged.

Neewer - Help You Build a Audio Video Workflow. With multiple locations over three continents, Neewer focuses on photography, video, and music equipment. We are committed to offering professional premium products to photographers, videographers, music lovers all over the world. We have listened to our customers and developed the items that meet their needs. Our items are not only desirable for their function, but also for the value that comes with the Neewer brand.

## CHARMING EYES & 3-DIMENSIONAL LOOK

👍 Different distances of lights show highlights in eyes; Facial features are enhanced under constant lighting and harsh shadows are reduced to make you MORE ATTRACTIVE.

## DIMMABLE LED LIGHT

- Adjustable Color Temperature from 3200K to 5600K -

Wide Application - You will NEED it and LOVE it



Makeup Artists/YouTube Content Creators/Video Bloggers



Studio Lighting/Portrait Photography/Selfie Lovers



Tattoo Artists/Hair Stylists/Salons

Compare with similar items

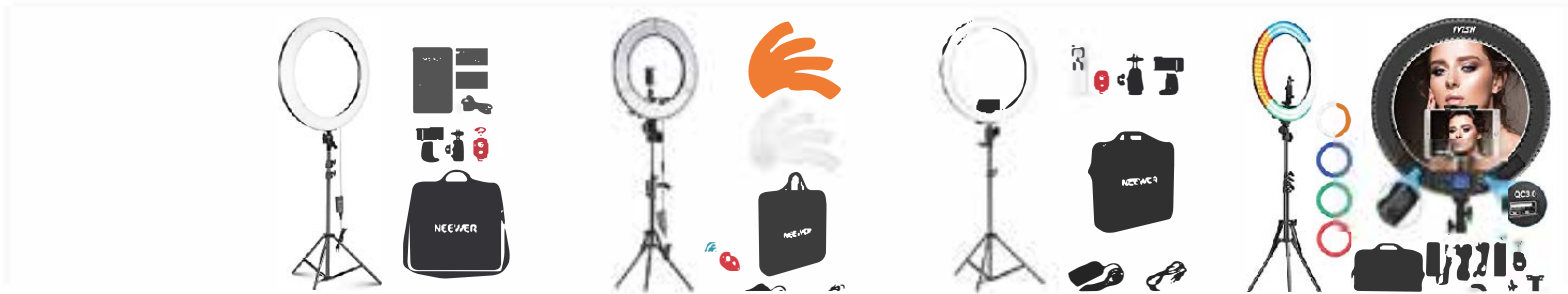

This item Neewer 20-inch LED Ring Light Kit for Makeup Youtube Video Blogger Salon - Adjustable Color Temperature with Battery or DC Power Option, Battery, Charger, AC Adapter, Phone Clamp and Stand Included

Add to Cart

Neewer Ring Light Kit:18"/48cm Outer SSW 5500K Dimmable LED Ring Light, Light Stand, Carrying Bag for Camera, Smartphone, YouTube, TikTok, Self-Portrait Shooting, Black, Model:10088612

#1 Best Seller

Add to Cart

Neewer Advanced 18-inch LED Ring Light Support Manual Touch Control with LCD Screen, 2.4G Remote and Multiple Light Control, 3200-5600K, Stand Included for Makeup YouTube Video Blogger Salon (Black)

Add to Cart

IVISI 19 inch Ring Light with Remote Controller and Stand iPad Holder, 60W Bi-Color with 4 Color Soft Filters for Live Stream/Makeup/YouTube Video/TikTok/Zoom/Photography

Add to Cart

Customer Rating	★★★★☆ (1035)	★★★★☆ (21676)	★★★★☆ (220)	★★★★☆ (1084)
Price	\$135.99	\$84.99	\$127.49	\$159.99
Shipping	FREE Shipping. Details	FREE Shipping. Details	FREE Shipping. Details	FREE Shipping. Details
Sold By	iphotoxx	iphotoxx	Global_omc	CAIYIN

**Product description**

Size: 20 inches

**PLEASE NOTE:**

1. Camera and Smart phone are not included.
2. Power will be lower about 10W when using battery and it can work about 48 minutes when batteries are fully charged.

**Description:**

Here comes a Complete Upgraded Neewer Ring Light Kit: 1. It is designed with 20-inch diameter and 352 pieces energy-saving SMD LED beads to provide more filling light; 2. It supports 2 power options: DC power adapter or NP-F550/970 replacement Li-ion batteries, so it is perfect to use in indoor and outdoor portrait photography, live show, YouTube video shooting, live streaming, make up artists, etc.

**44W Dimmable LED Ring Light:**

Outer Diameter: 20 inches/53 centimeters

Inner Diameter: 16 inches/42 centimeter

Power: 44W

2 Color Temperature: 3200K-5600K

Brightness Adjustment: 1%-100%

Compatible Battery Type: NP-F550/970 Battery (2 Replacement Battery Pack Included: 1 2V2600mAh and 1 USB Charger)

Voltage: DC 12-15V

Input Voltage: 100-120V 50/60Hz

**Light Stands:**

3-leg stage design and its solid locking system make sure all your stuff in safe when in use. Easy to fold in and set up.

Max. Load Capacity (approx): 17.5 pounds/ 8 kilograms

Adjustable Height: 36-79 inches/ 92-200 centimeters

**Phone Holder:**

Opening Width: 1.9-3.9 inches/5-10 centimeters; Fits for the majority of smart phone models in the market, such as iPhone X 8 7 plus 7 6 plus, Samsung S8 S7 56, Huawei, etc.

**Package Contents:**

- 1x 44W Dimmable LED Ring Light
- 2x Li-ion Battery
- 1x USB Battery Charger
- 1x Power Adapter with US Plug
- 1x Light Stand
- 1x Ball Head Adapter
- 1x Wireless Remote
- 1x Phone Holder
- 1x Carrying Case for Ring Light
- 1x Instruction Manual

**Product information**

Size: 20 inches

Package Dimensions	29.21 x 26.85 x 4.02 inches
--------------------	-----------------------------

Warranty & Support

**Product information**

Size: 20 inches

Package Dimensions	29.21 x 26.85 x 4.02 inches
Item Weight	11.53 pounds
ASIN	B07KQYH27B
Item model number	10094288
Batteries	1 AAA batteries required. (included)
Customer Reviews	★★★★☆ 1,035 ratings 4.5 out of 5 stars
Best Sellers Rank	#41 in Macro & Ringlight Flashes
Is Discontinued By Manufacturer	No
Date First Available	November 27, 2018
Manufacturer	Neewer

**Warranty & Support**

**Product Warranty:** For warranty information about this product, please [click here](#)

**Feedback**

Would you like to [tell us about a lower price?](#)

**Videos**

Page 1 of 2

**Videos for this product**

**Videos for related products**



Neewer Ring Light

Zona Reviews



2nd time I've ever used this light and it doesn't work

Shane



Are Dimmable LED Ring Light for video & photo Worth it? YES!

Is it Worth it?



IVISII Ring Light Unboxing

CALYIN



19in Pixel Ringlight Intro

Pixel Photography



Neewer Unboxi Merch

Upload your video

**Products related to this item**

Page 1 of 52

Sponsored



**Neewer Ring Light Kit: 18"/48cm Outer 55W 5500K Dimmable LED Ring Light, Light Stand...**  
★★★★☆ 21,590  
\$97.99 ✓prime



**IVISII 19 inch Ring Light with Stand and iPad & Phone Holder, 60W Bi-Color for Li...**  
★★★★☆ 71  
\$89.99 ✓prime



**GEEKOTO 18-inch LED Ring Light for Phone and Camera, 48W, 3200k-5600k Ring Light wi...**  
★★★★☆ 327  
\$105.99 ✓prime



**Selfie Ring Light, Dual 10" RGB Ring Light with Phone Holder, Shooting with 29 Cal...**  
★★★★☆ 38  
\$69.99 ✓prime



**Ring Light with Wireless Remote and iPad Holder, Pixel 19" Bi-Color LCD Display Rin...**  
★★★★☆ 592  
\$137.99 ✓prime



**19" RGB Ring Light with Stand, 48W Efficient LED Ring Light, Support Phone/Pad/Came...**  
★★★★☆ 49  
\$89.99 ✓prime



**18 inch Ring Light with Stand and Phone Holder, Remote Big Light Ring with Tripod f...**  
★★★★☆ 103  
\$86.99 ✓prime

**Customer questions & answers**

Have a question? Search for answers

- Question:** Does it come with a stand now?

**Answer:** Yes there is an adjustable stand, 2 batteries, power adaptor, a Bluetooth remote and the unit to attach your phone to.  
By Kyle Pinneo on July 6, 2018
- Question:** El mejor aro de luz cual es?

**Answer:** Este me parece espectacular y muy completo! Lo recomiendo!  
By Amazon Customer on September 4, 2019  
[See more answers \(1\)](#)
- Question:** Does it come with the remote to take the picture?

**Answer:** Yes it does  
By Amazon Customer on February 1, 2019
- Question:** Does this 20 inch ring light come with diffusion covers in the pictures?

**Answer:** Yes, it comes with translucent white diffusion covers installed

Question: Does it come with the remote to take the picture?  
Answer: Yes it does  
By Amazon Customer on February 1, 2019

Question: Does this 20 inch ring light come with diffusion covers in the pictures?  
Answer: Yes, it comes with translucent white diffusion covers installed.  
By Amazon Customer on April 25, 2019

See more answered questions (42)

Customer reviews

4.5 out of 5

1,035 global ratings

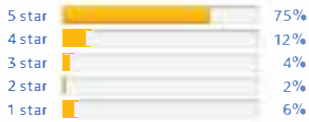

How are ratings calculated?

By feature

- Picture quality 4.6
Value for money 4.5
Brightness 4.5

See more

Review this product

Share your thoughts with other customers

Write a customer review

Customer images



See all customer images

Read reviews that mention

- stopped working, color temperature, inch ring, white and yellow, phone holder, bluetooth remote, lightstand, remote control, put together, led ring, waste of money, good quality, light kit

Top reviews

Top reviews from the United States



MK

Review of NEW model with "Bi Color" LED Ring - important design change

Reviewed in the United States on June 11, 2019

Verified Purchase

Neewer has come out with a new version of this ring light kit, and it looks like someone in the design department messed up!

For the older version, the ring light had a cold (hot) shoe mount which allowed you to put the ring on the included ball head and then adjust the angle of the light. Adjusting the angle of the light is important to avoid harsh light on the subject, and to avoid "halos" for anyone wearing glasses. Well, the new version no longer has the cold shoe adapter, so you can't adjust the angle of the light. They still include the ball head in the package, but it's not usable.

My solution was to put an old tripod head that I had lying around (Manfrotto #3229) on top of the light stand and below the ring light. This allows me to adjust the angle of the light. As an added bonus, this head has a quick release, so I can quickly pop the ring light on and off the light stand.

I've spoken with Neewer customer support, and after a few emails they acknowledged the change and that

Read more

42 people found this helpful

- Helpful, Comment, Report abuse



Tasca m

Great light! Used for diy photo booth setup

Reviewed in the United States on January 16, 2019

Verified Purchase

Great little light! I recently created my own diy photo booth using this light! Very affordable and allowed me to add another element to my wedding business for a fraction of the price! Most photo booth setups cost in the \$1,000 range and up! This cost me nowhere near the price and the light works flawless! Battery and wall options make it so versatile! Two battery's last easily 5 hours on half power which is more than enough.



27 people found this helpful

- Helpful, Comment, Report abuse



Ivet te Marie

Best product and quality!

Reviewed in the United States on July 8, 2018

24 people found this helpful  
Helpful Comment Report abuse

Ivette Marie

★★★★★ Best product and quality!

Reviewed in the United States on July 8, 2018

Verified Purchase

I really love this product! The pictures and videos are amazing when I use the ring light, is very easy to set up and very light to take every where!



24 people found this helpful

Helpful Comment Report abuse

Parola

★★★★☆ Powerful, great value, could be more practical

Reviewed in the United States on December 19, 2018

Verified Purchase

PROS:

- The light is POWERFUL, most of the time I don't need to set it at max power.
- This is not the largest ring available, but the light distribution is not worse because of that. Still lights people beautifully
- Having batteries makes every thing so much easier, you can use this anywhere!
- Battery life is pretty decent.

CONS:

- It's a pain to put it on/take it off the light stand. The screw is tiny and hard to handle.
- The ball head makes it hard to position the light the way you want it. It keeps falling. It feels loose. Sometimes it stays where you want it, but it's not easy to get that. This is definitely my biggest complaint.
- It uses 2 batteries but the charger only charges one at a time, pretty inconvenient.

Overall, I'm very happy with it. The results are beautiful and the price is totally worth it. If the light stand was easier to set up, I'd give it 5 stars.

14 people found this helpful

Helpful Comment Report abuse

Nathan Rose

★★★★☆ Great light, great battery, no tilt.

Reviewed in the United States on September 26, 2019

Verified Purchase

This ring light is excellent for the price. It's battery option has been amazing. It has not yet been used for its professional intention, but it's been used around the house and has no issues. Except for the fact that it's not tiltable, which when using it for makeup or photography is very important. See my photo for how I used some old mounts I had lying around to enable it to tilt. But this should have been a cheap and simple thing provided by newer from the start.



11 people found this helpful

Helpful Comment Report abuse

Trent Kelly

★★★★★ I definitely recommend a ring light of this size!

Reviewed in the United States on February 2, 2019

Size: 20 inches Verified Purchase

I know this brand, so I bought this 20-inch ring light almost immediately. The keywords I searched for were very simple, only the "20-inch ring light", so this is the first one that meets the requirements. It will really be bigger than you think, like a swimming ring. But the best thing about it is that its inner ring diameter is large enough. Unlike some products, the seller may claim that it is 18 inches, but the inner ring used to place the camera is actually only 14 inches in diameter. Regarding its function, I think you will know a lot when you google it. I definitely recommend a ring light of this size!

13 people found this helpful

Helpful Comment Report abuse

Sharon J

★★★★★ Lights me up

Reviewed in the United States on July 29, 2020

Size: 20 inches Verified Purchase

I came back for a second Neewer Ring Light. I loved my 14" and decided to upgrade. The 20" allows me to use my iPad Pro to capture videos and pictures. I also get more light coverage. I set up the light in minutes.



★★★★★ Lights me up

Reviewed in the United States on July 29, 2020

Size: 20 inches [Verified Purchase](#)

I came back for a second Neewer Ring Light. I loved my 14" and decided to upgrade. The 20" allows me to use my iPad Pro to capture videos and pictures. I also get more light coverage. I set up the light in minutes. See photo of me without light on, with cool lighting, and with warm lighting. I love that I don't have to switch filters. The clicker that comes with the order allows me to discreetly take several selfies. The smartphone holder isn't the best. I swapped it out with another one for more stability and now for a larger holder that holds iPad Pro size tablets



6 people found this helpful

[Helpful](#) [Comment](#) [Report abuse](#)



Neryda sifuentes

★★★★★ I was so happy to get this ring light!

Reviewed in the United States on December 11, 2018

[Verified Purchase](#)

I'm so happy I got this ring light! Came with a cute little camera remote that I can connect to the bluetooth on my phone and activate the camera's sensor from my phone with just the click of a button! It was so quick and easy to put together, just had to mount it to the stand and put in the batteries and I was good to go! I love that I can use it anywhere because it takes batteries and that they came with it as well as a charger! The light stays lit for hours and the lighting is really great for my filming. My youtube videos have perfect lighting since I can dim to adjust it so I can use it for bright and low level light. I can film right from the light as well and on my phone and camera since it comes with a holder that can attach either of them and shoot directly from inside the ring light on the tripod stand.

8 people found this helpful

[Helpful](#) [Comment](#) [Report abuse](#)

[See all reviews](#)

Top reviews from other countries

[Translate all reviews to English](#)



SCP

★★★★★ Schön großer, sehr heller LED Ring mit stufenloser Farbkalibrierung!

Reviewed in Germany on November 30, 2019

Size: 20 inches [Verified Purchase](#)

Ich suchte eine einfache Möglichkeit für die Beleuchtung von einzelnen Talenten. Die gängigen LED Panels sind zwar praktisch, jedoch sehr punktuell und hart. Softboxen sind mir zu sperrig. Der Ring ist ausreichend soft und durch die 50cm Durchmesser sich so breit ausleuchtend wie 4 LED Panels, ohne dabei die Härte im mittleren Sichtbereich zu erzeugen.

Das Teil ist angenehm leicht - manche würden sagen "billig verarbeitet", ich bin froh über jedes gesparte Kilo und finde, dass der Ring voll kommen sauber verarbeitet wurde.

Die Stromversorgung per Netzteil gefällt mir aufgrund der langen Kabel sehr, sicher über 2 Meter. Top. Die Akkus sind eine nette Dreingabe, ich würde mich bei einem Videodreh nicht drauf verlassen. Bei einer Fotosession wäre es ok, dort macht es weniger aus wenn die auf einmal leer sind. Auch bei großen Akkus wäre ich immer vorsichtig...zudem ist der Ring mit Netzteil noch ein Stückchen heller.

Die Tasche ist ausreichend gross um das Netzteil mit zu verstauen und sie ist gepolstert. Auch bei vollern Auto findet der Ring noch irgendwo Platz, die Höhe der Tasche ist unter 10cm.

Das kleine Lichtstativ ist ok. Die Zubehörteile ebenfalls

Alles in allem finde ich den Preis gerechtfertigt und das Licht ausreichend hell und soft.



35 people found this helpful

[Report abuse](#)

[Translate review to English](#)



Rothtauscher

★★★★★ Hochwertiges Ringlicht Set

Reviewed in Germany on July 26, 2019

Size: 20 inches [Verified Purchase](#)

Ich habe schon so einige billigere Varianten ausprobiert und hat immer nicht so geklappt aber dieses Set ist sehr hochwertig und das PreisLeistungs Verhältnis stimmt und Stabilität und Lichtleistung ist super

28 people found this helpful

[Report abuse](#)

★★★★★ **Hochwertiges Ringlicht set**

Reviewed in Germany on July 26, 2019

4.9 out of 5 stars **Verified Purchase**

Ich habe schon so einige billigere Varianten ausprobiert und hat immer nicht so geklappt aber dieses Set ist sehr hochwertig und das Preis Leistungs Verhältnis stimmt und Stabilität und Lichtleistung ist super

28 people found this helpful

Report abuse

Translate review to English



J. Jackson

★★★★★ **Highly recommend this for the price!**

Reviewed in Canada on June 7, 2018

Verified Purchase



Attached unboxing video! Everything advertised was supplied. 3 settings for the lights plus dimmers. Easily adjustable everywhere (stand, shoe, light). Sturdy Easy to assemble with or without instructions. Also compatible with S7. (took a chance and it fit Yay) took my first video and panicked because I could see the back of the ring. But then I realized I didnt adjust it properly. All solved! Lol. Great buy. Im glad I made the leap and bought it!



32 people found this helpful

Report abuse



raabie

★★★★★ **Der absolute Hammer**

Reviewed in Germany on August 1, 2019

Size: 20 inches **Verified Purchase**

Dieses Ringlicht ist super, man kann den Unterschied zu anderen Beleuchtung deutlich erkennen und wer einmal mit dem gearbeitet hat will nicht mehr ohne sein

26 people found this helpful

Report abuse

Translate review to English



bjh

★★★★★ **Easy und schnell, schönes Licht - für innen & außen**

Reviewed in Germany on November 4, 2019

Size: 20 inches **Verified Purchase**

Tolles Preis - Leistungsverhältnis. Super handlich, prima für ein tolles Foto mit kleinem Aufwand. Perfekt fürs kleine Gepäck - schnelle Pups draußen.

21 people found this helpful







Report abuse

Translate review to English

See all reviews

4 stars and above

Sponsored

 <p><b>Neewer Ring Light Kit: 18"/48cm Outer SSW 5500K Dimmable LED Ring Light, Light Stand...</b>                  ★★★★★ 21,590                  \$97.99 ✓prime</p>	 <p><b>TaoTronics 12" Ring Light with Stand, Selfie Ring Light Outer 24W with USB Mobile...</b>                  ★★★★★ 152                  \$88.99 ✓prime</p>	 <p><b>18" LED Ring Light with Stand, Wireless Remote Control LCD Screen with Phone Holde...</b>                  ★★★★★ 134                  \$89.97 ✓prime</p>	 <p><b>19 inches Ring Light Kit, SAMTIAN Dimmable LED Selfie Ring Light with 78" Light St...</b>                  ★★★★★ 404                  \$79.99 ✓prime</p>	 <p><b>Travor 18" LED Ring Light with Light Stand and Phone Holder Kit, Dimmable 3200K/550...</b>                  ★★★★★ 453                  \$79.99 ✓prime</p>	 <p><b>iDesi Dual Ring Light, 11 Light Modes, 2700 6500K, 2020 Upgraded 7" Dimmable Led Ri...</b>                  ★★★★★ 452                  \$33.99 ✓prime</p>	 <p><b>GEEKOTO 18-inch LED Ring Light for Phone and Camera, 48W, 3200k-5600k Ring Light wi...</b>                  ★★★★★ 327                  \$105.99 ✓prime</p>
---	---	--	--	--	---	--

Neewer Ring Light Kit:18"/48cm Outer 55W 5500K Dimmable LED Ring Light, Light Stand...  
★★★★☆ 21,590  
\$97.99 ✓prime

Light with Stand, Selfie Ring Light Outer 24W with USB Mobile ...  
★★★★★ 152  
\$88.99 ✓prime

Light with Stand, Wireless Remote Control LCD Screen with Phone Holde...  
★★★★★ 134  
\$89.97 ✓prime

Light with Stand, Selfie Ring Light with 78" Light St...  
★★★★★ 404  
\$79.99 ✓prime

Light with Light Stand and Phone Holder Kit, Dimmable 3200K/550...  
★★★★★ 453  
\$79.99 ✓prime

Light Modes, 2700 6500K, 2020 Upgraded 7" Dimmable Led Ri...  
★★★★☆ 452  
\$33.99 ✓prime

18-inch LED Ring Light for Phone and Camera, 48W, 3200k-5600k Ring Light wi...  
★★★★☆ 327  
\$105.99 ✓prime

Pages with related products. See and discover other items: Landscape Cameras, color ring, Energy Saving Lights, Cameras with Video Option, Makeup Cameras, Explore Ringlight Flashes

### Deals in magazine subscriptions

Page 1 of 8



Travel + Leisure  
★★★★★ 860  
Print Magazine  
\$5.00



Family Handyman  
★★★★★ 12,189  
Print Magazine  
\$5.00



Do it Yourself  
★★★★★ 24  
Print Magazine  
\$3.00



Women's Health  
★★★★★ 42  
Print Magazine  
\$6.00



EatingWell  
★★★★★ 3,981  
Print Magazine  
\$3.00



Reader's Digest  
★★★★★ 90  
Print Magazine  
\$5.00



National Geographic Kids  
★★★★★ 7,137  
Print Magazine  
\$10.00

### Inspired by your browsing history

Page 1 of 7



Cheaplights - Heavy Duty Muslin Clamps 4 1/2 inch 6 Pack  
★★★★★ 8,606  
\$7.79



Neewer 2 Packs Dimmable 5600K USB LED Video Light with Adjustable Tripod...  
★★★★★ 5,483  
\$42.99



Professional Grade Lavalier Lapel Microphone Omnidirectional Mic...  
★★★★★ 8,373  
\$39.99



SanDisk 128GB Extreme PRO SDXC UHS-I Card - C10, U3, V30, 4K UHD, SD Card - SDCSDXXY...  
★★★★★ 53,005  
\$36.17



HPUSN Photo Video Studio 10ft. Adjustable Backdrop Stand for Wedding Party Stage...  
★★★★★ 486  
\$59.99



20 Pieces Lash Shampoo Brushes, Peel Off Blackhead Brush Remover Tool, Nose...  
★★★★★ 870  
\$13.99



Neewer 6 x 9FT / 18 x 2.8M Photo Studio 100% Pure Muslin Collapsible Backdrop Background...  
★★★★★ 3,559  
\$17.99

### Your Browsing History

[View or edit your browsing history](#)

Page 1 of 2

[See personalized recommendations](#)

[Sign in](#)  
New customer? Start here



[Back to top](#)

#### Get to Know Us

- [Careers](#)
- [Blog](#)
- [About Amazon](#)
- [Sustainability](#)
- [Press Center](#)
- [Investor Relations](#)
- [Amazon Devices](#)
- [Amazon Tours](#)

#### Make Money with Us

- [Sell products on Amazon](#)
- [Sell apps on Amazon](#)
- [Become an Affiliate](#)
- [Advertise Your Products](#)
- [Self-Publish with Us](#)
- [Host an Amazon Hub](#)
- [See More Make Money with Us](#)

#### Amazon Payment Products

- [Amazon Rewards Visa Signature Cards](#)
- [Amazon.com Store Card](#)
- [Amazon Business Card](#)
- [Amazon Business Line of Credit](#)
- [Shop with Points](#)
- [Credit Card Marketplace](#)
- [Reload Your Balance](#)
- [Amazon Currency Converter](#)

#### Let Us Help You

- [Amazon and COVID-19](#)
- [Your Account](#)
- [Your Orders](#)
- [Shipping Rates & Policies](#)
- [Amazon Prime](#)
- [Returns & Replacements](#)
- [Manage Your Content and Devices](#)
- [Amazon Assistant](#)
- [Help](#)



English

United States

[Amazon Music](#)  
Discover millions of songs

[Amazon Advertising](#)  
Reach, activate, and engage customers

[Amazon Drive](#)  
Unlimited digital storage

[Amazon](#)  
Shop millions of products

[AbeBooks](#)  
Books, art & collectibles

[ACX](#)  
Audiobook Publishing Made Easy

[Alexa](#)  
Empowering People with Voice

Travel + Leisure  
★★★★★ 860  
Print Magazine  
\$5.00

Early July  
★★★★★ 12,189  
Print Magazine  
\$5.00

6 + 1  
★★★★★ 24  
Print Magazine  
\$3.00

Travel + Leisure  
★★★★★ 42  
Print Magazine  
\$6.00

Travel + Leisure  
★★★★★ 3,981  
Print Magazine  
\$3.00

Reader's Digest  
★★★★★ 90  
Print Magazine  
\$5.00

National Geographic Kids  
★★★★★ 7,157  
Print Magazine  
\$10.00

### Inspired by your browsing history

Page 1 of 7

<



**Cheaplights - Heavy Duty Muslin Clamps 4 1/2 inch 6 Pack**  
★★★★★ 8,606  
\$7.79



**Neewer 2 Packs Dimmable 5600K USB LED Video Light with Adjustable Tripod...**  
★★★★★ 5,485  
\$42.99



**Professional Grade Lavalier Lapel Microphone Omnidirectional Mic...**  
★★★★★ 8,373  
\$39.99



**SanDisk 128GB Extreme PRO SDXC UHS-I Card - C10, U3, V30, 4K UHD, SD Card - SDSD128G...**  
★★★★★ 53,005  
\$36.17



**HPUSN Photo Video Studio 10ft. Adjustable Backdrop Stand for Wedding Party Stage...**  
★★★★★ 486  
\$59.99



**20 Pieces Lash Shampoo Brushes, Peel Off Blackhead Brush Remover Tool, Nose...**  
★★★★★ 870  
\$13.99



**Neewer 6 x 9FT / 1.8 x 2.8M Photo Studio 100% Pure Muslin Collapsible Backdrop Background...**  
★★★★★ 3,559  
\$17.99

>

### Your Browsing History [View or edit your browsing history](#)

Page 1 of 2

See personalized recommendations

[Sign in](#)

New customer? [Start here.](#)

<

>

[Back to top](#)

#### Get to Know Us

- [Careers](#)
- [Blog](#)
- [About Amazon](#)
- [Sustainability](#)
- [Press Center](#)
- [Investor Relations](#)
- [Amazon Devices](#)
- [Amazon Tours](#)

#### Make Money with Us

- [Sell products on Amazon](#)
- [Sell apps on Amazon](#)
- [Become an Affiliate](#)
- [Advertise Your Products](#)
- [Self-Publish with Us](#)
- [Host an Amazon Hub](#)
- [See More Make Money with Us](#)

#### Amazon Payment Products

- [Amazon Rewards Visa Signature Cards](#)
- [Amazon.com Store Card](#)
- [Amazon Business Card](#)
- [Amazon Business Line of Credit](#)
- [Shop with Points](#)
- [Credit Card Marketplace](#)
- [Reload Your Balance](#)
- [Amazon Currency Converter](#)

#### Let Us Help You

- [Amazon and COVID-19](#)
- [Your Account](#)
- [Your Orders](#)
- [Shipping Rates & Policies](#)
- [Amazon Prime](#)
- [Returns & Replacements](#)
- [Manage Your Content and Devices](#)
- [Amazon Assistant](#)
- [Help](#)



English

United States

**Amazon Music**  
Stream millions of songs

**Amazon Advertising**  
Find, attract, and engage customers

**Amazon Drive**  
Cloud storage from Amazon

**6pm**  
Score deals on fashion brands

**AbeBooks**  
Books, art & collectibles

**ACX**  
Audiobook Publishing Made Easy

**Alexa**  
Actionable Analytics for the Web

**Sell on Amazon**  
Start a Selling Account

**Amazon Business**  
Everything For Your Business

**Amazon Fresh**  
Groceries & More Right To Your Door

**AmazonGlobal**  
Ship Orders Internationally

**Home Services**  
Experienced Pros. Happiness Guarantee

**Amazon Ignite**  
Sell your original Digital Educational Resources

**Amazon Rapids**  
Fun stories for kids on the go

**Amazon Web Services**  
Scalable Cloud Computing Services

**Audible**  
Listen to Books & Original Audio Performances

**Book Depository**  
Books With Free Delivery Worldwide

**Box Office Mojo**  
Find Movie Box Office Data

**ComiKology**  
Thousands of Digital Comics

**DPRReview**  
Digital Photography

**East Dane**  
Designer Men's Fashion

**Fabric**  
Sewing, Quilting & Knitting

**Goodreads**  
Book reviews & recommendations

**IMDb**  
Movies, TV & Celebrities

**IMDbPro**  
Get Info Entertainment Professionals Need

**Kindle Direct Publishing**  
Indie Digital & Print Publishing Made Easy

**Prime Now**  
FREE 2-hour Delivery on Everyday Items

**Amazon Photos**  
Unlimited Photo Storage Free With Prime

**Prime Video Direct**  
Video Distribution Made Easy

**Shopbop**  
Designer Fashion Brands

**Amazon Warehouse**  
Great Deals on Quality Used Products

**Whole Foods Market**  
America's Healthiest Grocery Store

**Woot!**  
Deals and Shenanigans

**Zappos**  
Shoes & Clothing

**Ring**  
Smart Home Security Systems

**eero WiFi**  
Stream 4K Video in Every Room

**Neighbors App**  
Real-Time Crime & Safety Alerts

**Amazon Subscription Boxes**  
Top subscription boxes - right to your door

**PillPack**  
Pharmacy Simplified

**Amazon Renewed**  
Like-new products you can trust

**Amazon Second Chance**  
Pass it on, trade it in, give it a second life