

3GPP TS 38.321 V15.3.0 (2018-09)

Technical Specification

**3rd Generation Partnership Project;
Technical Specification Group Radio Access Network;
NR;
Medium Access Control (MAC) protocol specification
(Release 15)**



The present document has been developed within the 3rd Generation Partnership Project (3GPP™) and may be further elaborated for the purposes of 3GPP. The present document has not been subject to any approval process by the 3GPP Organizational Partners and shall not be implemented. This Specification is provided for future development work within 3GPP only. The Organizational Partners accept no liability for any use of this Specification. Specifications and Reports for implementation of the 3GPP™ system should be obtained via the 3GPP Organizational Partners' Publications Offices.

3GPP

Postal address

3GPP support office address

650 Route des Lucioles - Sophia Antipolis
Valbonne - FRANCE
Tel.: +33 4 92 94 42 00 Fax: +33 4 93 65 47 16

Internet

<http://www.3gpp.org>

Copyright Notification

No part may be reproduced except as authorized by written permission.
The copyright and the foregoing restriction extend to reproduction in all media.

© 2018, 3GPP Organizational Partners (ARIB, ATIS, CCSA, ETSI, TSDSI, TTA, TTC).
All rights reserved.

UMTS™ is a Trade Mark of ETSI registered for the benefit of its members
3GPP™ is a Trade Mark of ETSI registered for the benefit of its Members and of the 3GPP Organizational Partners
LTE™ is a Trade Mark of ETSI registered for the benefit of its Members and of the 3GPP Organizational Partners
GSM® and the GSM logo are registered and owned by the GSM Association

Contents

Foreword.....	6
1 Scope.....	7
2 References.....	7
3 Definitions, symbols and abbreviations.....	7
3.1 Definitions.....	7
3.2 Abbreviations.....	8
4 General.....	9
4.1 Introduction.....	9
4.2 MAC architecture.....	9
4.2.1 General.....	9
4.2.2 MAC Entities.....	9
4.3 Services.....	10
4.3.1 Services provided to upper layers.....	10
4.3.2 Services expected from physical layer.....	11
4.4 Functions.....	11
4.5 Channel structure.....	11
4.5.1 General.....	11
4.5.2 Transport Channels.....	11
4.5.3 Logical Channels.....	12
4.5.4 Mapping of Transport Channels to Logical Channels.....	12
4.5.4.1 General.....	12
4.5.4.2 Uplink mapping.....	12
4.5.4.3 Downlink mapping.....	12
5 MAC procedures.....	13
5.1 Random Access procedure.....	13
5.1.1 Random Access procedure initialization.....	13
5.1.2 Random Access Resource selection.....	15
5.1.3 Random Access Preamble transmission.....	18
5.1.4 Random Access Response reception.....	18
5.1.5 Contention Resolution.....	20
5.1.6 Completion of the Random Access procedure.....	22
5.2 Maintenance of Uplink Time Alignment.....	22
5.3 DL-SCH data transfer.....	23
5.3.1 DL Assignment reception.....	23
5.3.2 HARQ operation.....	25
5.3.2.1 HARQ Entity.....	25
5.3.2.2 HARQ process.....	25
5.3.3 Disassembly and demultiplexing.....	26
5.4 UL-SCH data transfer.....	26
5.4.1 UL Grant reception.....	26
5.4.2 HARQ operation.....	28
5.4.2.1 HARQ Entity.....	28
5.4.2.2 HARQ process.....	29
5.4.3 Multiplexing and assembly.....	30
5.4.3.1 Logical Channel Prioritization.....	30
5.4.3.1.1 General.....	30
5.4.3.1.2 Selection of logical channels.....	30
5.4.3.1.3 Allocation of resources.....	31
5.4.3.2 Multiplexing of MAC Control Elements and MAC SDUs.....	32
5.4.4 Scheduling Request.....	32
5.4.5 Buffer Status Reporting.....	33
5.4.6 Power Headroom Reporting.....	35
5.5 PCH reception.....	37
5.6 BCH reception.....	37

5.7	Discontinuous Reception (DRX).....	37
5.8	Transmission and reception without dynamic scheduling.....	40
5.8.1	Downlink.....	40
5.8.2	Uplink.....	40
5.9	Activation/Deactivation of SCells.....	41
5.10	Activation/Deactivation of PDCP duplication.....	43
5.11	MAC reconfiguration.....	43
5.12	MAC Reset.....	43
5.13	Handling of unknown, unforeseen and erroneous protocol data.....	44
5.14	Handling of measurement gaps.....	44
5.15	Bandwidth Part (BWP) operation.....	44
5.16	SUL operation.....	47
5.17	Beam Failure Detection and Recovery procedure.....	47
5.18	Handling of MAC CEs.....	48
5.18.1	General.....	48
5.18.2	Activation/Deactivation of Semi-persistent CSI-RS/CSI-IM resource set.....	48
5.18.3	Aperiodic CSI Trigger State subselection.....	49
5.18.4	Activation/Deactivation of UE-specific PDSCH TCI state.....	49
5.18.5	Indication of TCI state for UE-specific PDCCH.....	49
5.18.6	Activation/Deactivation of Semi-persistent CSI reporting on PUCCH.....	49
5.18.7	Activation/Deactivation of Semi-persistent SRS.....	49
5.18.8	Activation/Deactivation of spatial relation of PUCCH resource.....	50
5.18.9	Activation/Deactivation of semi-persistent ZP CSI-RS resource set.....	50
5.18.10	Recommended Bit Rate.....	50
6	Protocol Data Units, formats and parameters.....	51
6.1	Protocol Data Units.....	51
6.1.1	General.....	51
6.1.2	MAC PDU (DL-SCH and UL-SCH except transparent MAC and Random Access Response).....	51
6.1.3	MAC Control Elements (CEs).....	52
6.1.3.1	Buffer Status Report MAC CEs.....	52
6.1.3.2	C-RNTI MAC CE.....	56
6.1.3.3	UE Contention Resolution Identity MAC CE.....	56
6.1.3.4	Timing Advance Command MAC CE.....	56
6.1.3.5	DRX Command MAC CE.....	57
6.1.3.6	Long DRX Command MAC CE.....	57
6.1.3.7	Configured Grant Confirmation MAC CE.....	57
6.1.3.8	Single Entry PHR MAC CE.....	57
6.1.3.9	Multiple Entry PHR MAC CE.....	58
6.1.3.10	SCell Activation/Deactivation MAC CEs.....	60
6.1.3.11	Duplication Activation/Deactivation MAC CE.....	61
6.1.3.12	SP CSI-RS / CSI-IM Resource Set Activation/Deactivation MAC CE.....	61
6.1.3.13	Aperiodic CSI Trigger State Subselection MAC CE.....	62
6.1.3.14	TCI States Activation/Deactivation for UE-specific PDSCH MAC CE.....	63
6.1.3.15	TCI State Indication for UE-specific PDCCH MAC CE.....	63
6.1.3.16	SP CSI reporting on PUCCH Activation/Deactivation MAC CE.....	64
6.1.3.17	SP SRS Activation/Deactivation MAC CE.....	64
6.1.3.18	PUCCH spatial relation Activation/Deactivation MAC CE.....	66
6.1.3.19	SP ZP CSI-RS Resource Set Activation/Deactivation MAC CE.....	66
6.1.3.20	Recommended bit rate MAC CE.....	67
6.1.4	MAC PDU (transparent MAC).....	68
6.1.5	MAC PDU (Random Access Response).....	68
6.2	Formats and parameters.....	69
6.2.1	MAC subheader for DL-SCH and UL-SCH.....	69
6.2.2	MAC subheader for Random Access Response.....	70
6.2.3	MAC payload for Random Access Response.....	71
7	Variables and constants.....	71
7.1	RNTI values.....	71
7.2	Backoff Parameter values.....	72
7.3	DELTA_PREAMBLE values.....	73
7.4	PRACH Mask Index values.....	74

Annex A (informative): **Change history**75

Foreword

This Technical Specification has been produced by the 3rd Generation Partnership Project (3GPP).

The contents of the present document are subject to continuing work within the TSG and may change following formal TSG approval. Should the TSG modify the contents of the present document, it will be re-released by the TSG with an identifying change of release date and an increase in version number as follows:

Version x.y.z

where:

- x the first digit:
 - 1 presented to TSG for information;
 - 2 presented to TSG for approval;
 - 3 or greater indicates TSG approved document under change control.
- y the second digit is incremented for all changes of substance, i.e. technical enhancements, corrections, updates, etc.
- z the third digit is incremented when editorial only changes have been incorporated in the document.

1 Scope

The present document specifies the NR MAC protocol.

2 References

The following documents contain provisions which, through reference in this text, constitute provisions of the present document.

- References are either specific (identified by date of publication, edition number, version number, etc.) or non-specific.
- For a specific reference, subsequent revisions do not apply.
- For a non-specific reference, the latest version applies. In the case of a reference to a 3GPP document (including a GSM document), a non-specific reference implicitly refers to the latest version of that document *in the same Release as the present document*.

- [1] 3GPP TR 21.905: "Vocabulary for 3GPP Specifications".
- [2] 3GPP TS 38.300: "NR; Overall description; Stage 2".
- [3] 3GPP TS 38.322: "NR; Radio Link Control (RLC) protocol specification".
- [4] 3GPP TS 38.323: "NR; Packet Data Convergence Protocol (PDCP) protocol specification".
- [5] 3GPP TS 38.331: "NR; Radio Resource Control (RRC); Protocol specification".
- [6] 3GPP TS 38.213: "NR; Physical Layer Procedures for control".
- [7] 3GPP TS 38.214: "NR; Physical Layer Procedures for data".
- [8] 3GPP TS 38.211: "NR; Physical channels and modulation".
- [9] 3GPP TS 38.212: "NR; Multiplexing and channel coding".
- [10] 3GPP TS 38.101: "NR; User Equipment (UE) radio transmission and reception".
- [11] 3GPP TS 38.133: "NR; Requirements for support of radio resource management".
- [12] 3GPP TS 36.133: "Evolved Universal Terrestrial Radio Access (E-UTRA); Requirements for support of radio resource management".
- [13] 3GPP TS 26.114: "Technical Specification Group Services and System Aspects; IP Multimedia Subsystem (IMS); Multimedia Telephony; Media handling and interaction"

3 Definitions, symbols and abbreviations

3.1 Definitions

For the purposes of the present document, the terms and definitions given in 3GPP TR 21.905 [1] and the following apply. A term defined in the present document takes precedence over the definition of the same term, if any, in 3GPP TR 21.905 [1].

HARQ information: HARQ information for DL-SCH or for UL-SCH transmissions consists of New Data Indicator (NDI), Transport Block size (TBS), Redundancy Version (RV), and HARQ process ID.

Msg3: Message transmitted on UL-SCH containing a C-RNTI MAC CE or CCCH SDU, submitted from upper layer and associated with the UE Contention Resolution Identity, as part of a random access procedure.

PDCCH occasion: A time duration (i.e. one or a consecutive number of symbols) during which the MAC entity is configured to monitor the PDCCH.

Serving Cell: A PCell, a PSCell, or an SCell in TS 38.331 [5].

Special Cell: For Dual Connectivity operation the term Special Cell refers to the PCell of the MCG or the PSCell of the SCG depending on if the MAC entity is associated to the MCG or the SCG, respectively. Otherwise the term Special Cell refers to the PCell. A Special Cell supports PUCCH transmission and contention-based Random Access, and is always activated.

Timing Advance Group: A group of Serving Cells that is configured by RRC and that, for the cells with a UL configured, using the same timing reference cell and the same Timing Advance value. A Timing Advance Group containing the SpCell of a MAC entity is referred to as Primary Timing Advance Group (PTAG), whereas the term Secondary Timing Advance Group (STAG) refers to other TAGs.

NOTE: A timer is running once it is started, until it is stopped or until it expires; otherwise it is not running. A timer can be started if it is not running or restarted if it is running. A Timer is always started or restarted from its initial value. The duration of a timer is not updated until they are stopped or expires (e.g. due to BWP switching).

3.2 Abbreviations

For the purposes of the present document, the abbreviations given in 3GPP TR 21.905 [1] and the following apply. An abbreviation defined in the present document takes precedence over the definition of the same abbreviation, if any, in 3GPP TR 21.905 [1].

BSR	Buffer Status Report
BWP	Bandwidth Part
CE	Control Element
CSI	Channel State Information
CSI-IM	CSI Interference Measurement
CSI-RS	CSI Reference Signal
CS-RNTI	Configured Scheduling RNTI
INT-RNTI	Interruption RNTI
LCG	Logical Channel Group
LCP	Logical Channel Prioritization
MCG	Master Cell Group
NUL	Normal Uplink
NZP CSI-RS	Non-Zero Power CSI-RS
PHR	Power Headroom Report
PTAG	Primary Timing Advance Group
QCL	Quasi co-location
RS	Reference Signal
SCG	Secondary Cell Group
SFI-RNTI	Slot Format Indication RNTI
SI	System Information
SpCell	Special Cell
SP	Semi-Persistent
SP-CSI-RNTI	Semi-Persistent CSI RNTI
SPS	Semi-Persistent Scheduling
SR	Scheduling Request
SS	Synchronization Signals
SSB	Synchronization Signal Block
STAG	Secondary Timing Advance Group
SUL	Supplementary Uplink
TAG	Timing Advance Group
TCI	Transmission Configuration Indicator
TPC-SRS-RNTI	Transmit Power Control-Sounding Reference Symbols-RNTI
ZP CSI-RS	Zero Power CSI-RS

4 General

4.1 Introduction

The objective of this section is to describe the MAC architecture and the MAC entity of the UE from a functional point of view.

4.2 MAC architecture

4.2.1 General

This subclause describes a model of the MAC i.e. it does not specify or restrict implementations.

RRC is in control of the MAC configuration.

4.2.2 MAC Entities

The MAC entity of the UE handles the following transport channels:

- Broadcast Channel (BCH);
- Downlink Shared Channel(s) (DL-SCH);
- Paging Channel (PCH);
- Uplink Shared Channel(s) (UL-SCH);
- Random Access Channel(s) (RACH).

When the UE is configured with SCG, two MAC entities are configured to the UE: one for the MCG and one for the SCG.

The functions of the different MAC entities in the UE operate independently unless otherwise specified. The timers and parameters used in each MAC entity are configured independently unless otherwise specified. The Serving Cells, C-RNTI, radio bearers, logical channels, upper and lower layer entities, LCGs, and HARQ entities considered by each MAC entity refer to those mapped to that MAC entity unless otherwise specified.

If the MAC entity is configured with one or more SCells, there are multiple DL-SCH and there may be multiple UL-SCH as well as multiple RACH per MAC entity; one DL-SCH, one UL-SCH, and one RACH on the SpCell, one DL-SCH, zero or one UL-SCH and zero or one RACH for each SCell.

If the MAC entity is not configured with any SCell, there is one DL-SCH, one UL-SCH, and one RACH per MAC entity.

Figure 4.2.2-1 illustrates one possible structure of the MAC entity when SCG is not configured.

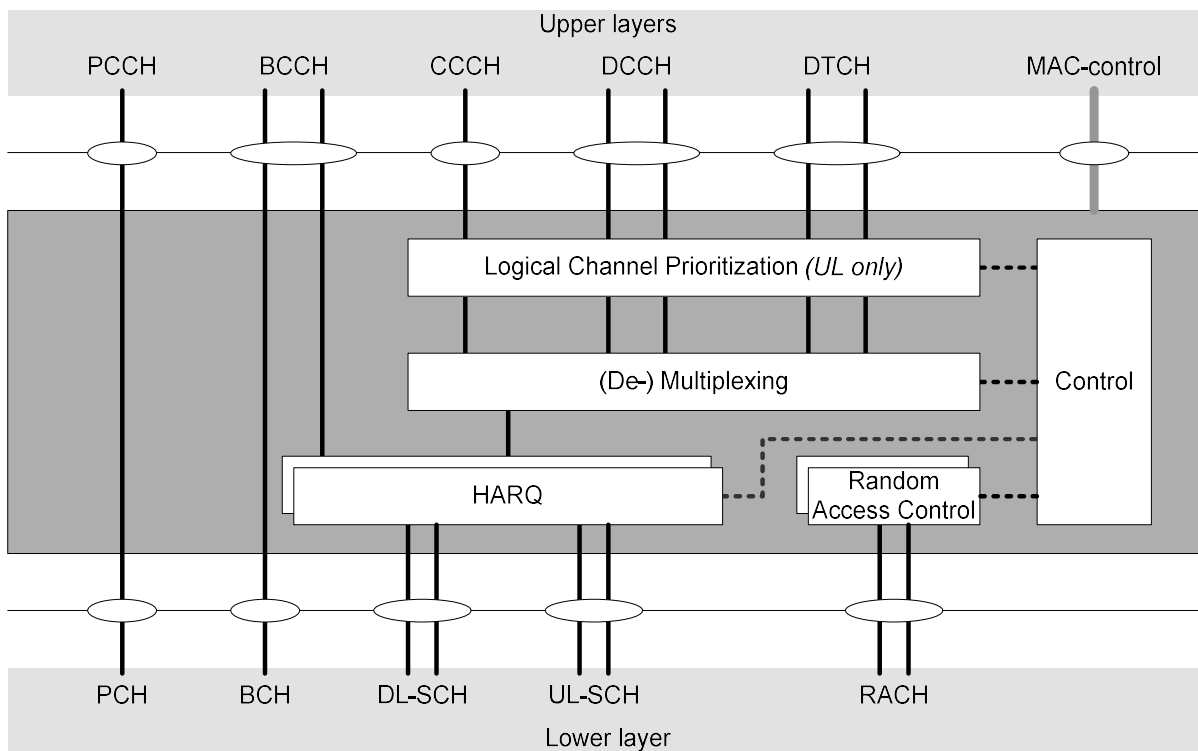

Figure 4.2.2-1: MAC structure overview

Figure 4.2.2-2 illustrates one possible structure for the MAC entities when MCG and SCG are configured.

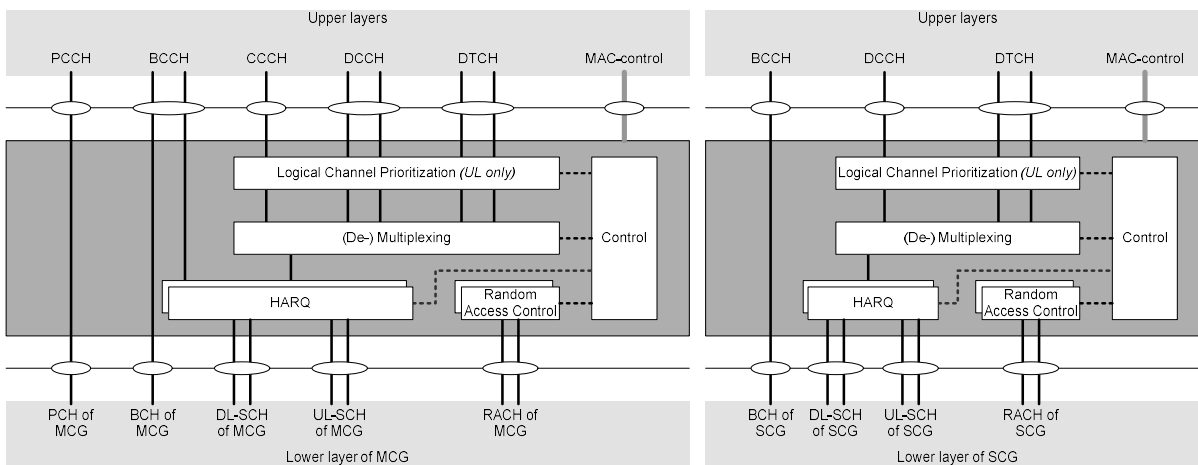

Figure 4.2.2-2: MAC structure overview with two MAC entities

4.3 Services

4.3.1 Services provided to upper layers

The MAC sublayer provides the following services to upper layers:

- data transfer;
- radio resource allocation.

4.3.2 Services expected from physical layer

The MAC sublayer expects the following services from the physical layer:

- data transfer services;
- signalling of HARQ feedback;
- signalling of Scheduling Request;
- measurements (e.g. Channel Quality Indication (CQI)).

4.4 Functions

The MAC sublayer supports the following functions:

- mapping between logical channels and transport channels;
- multiplexing of MAC SDUs from one or different logical channels onto transport blocks (TB) to be delivered to the physical layer on transport channels;
- demultiplexing of MAC SDUs to one or different logical channels from transport blocks (TB) delivered from the physical layer on transport channels;
- scheduling information reporting;
- error correction through HARQ;
- logical channel prioritisation.

The relevance of MAC functions for uplink and downlink is indicated in Table 4.4-1.

Table 4.4-1: The link direction association of MAC functions.

MAC function	Downlink	Uplink
Mapping between logical channels and transport channels	X	X
Multiplexing		X
Demultiplexing	X	
Scheduling information reporting		X
Error correction through HARQ	X	X
Logical Channel prioritisation		X

4.5 Channel structure

4.5.1 General

The MAC sublayer operates on the channels defined below; transport channels are SAPs between MAC and Layer 1, logical channels are SAPs between MAC and RLC.

4.5.2 Transport Channels

The MAC sublayer uses the transport channels listed in Table 4.5.2-1 below.

Table 4.5.2-1: Transport channels used by MAC

Transport channel name	Acronym	Downlink	Uplink
Broadcast Channel	BCH	X	
Downlink Shared Channel	DL-SCH	X	
Paging Channel	PCH	X	
Uplink Shared Channel	UL-SCH		X
Random Access Channel	RACH		X

4.5.3 Logical Channels

The MAC sublayer provides data transfer services on logical channels. To accommodate different kinds of data transfer services, multiple types of logical channels are defined i.e. each supporting transfer of a particular type of information.

Each logical channel type is defined by what type of information is transferred.

The MAC sublayer provides the control and traffic channels listed in Table 4.5.3-1 below.

Table 4.5.3-1: Logical channels provided by MAC.

Logical channel name	Acronym	Control channel	Traffic channel
Broadcast Control Channel	BCCH	X	
Paging Control Channel	PCCH	X	
Common Control Channel	CCCH	X	
Dedicated Control Channel	DCCH	X	
Dedicated Traffic Channel	DTCH		X

4.5.4 Mapping of Transport Channels to Logical Channels

4.5.4.1 General

Both for uplink and downlink, the MAC entity is responsible for mapping logical channels onto transport channels. This mapping depends on the multiplexing that is configured by RRC.

4.5.4.2 Uplink mapping

The uplink logical channels can be mapped as described in Table 4.5.4.2-1.

Table 4.5.4.2-1: Uplink channel mapping.

Logical channel \ Transport channel	UL-SCH	RACH
CCCH	X	
DCCH	X	
DTCH	X	

4.5.4.3 Downlink mapping

The downlink logical channels can be mapped as described in Table 4.5.4.3-1.

Table 4.5.4.3-1: Downlink channel mapping.

Transport channel Logical channel	BCH	PCH	DL-SCH
BCCH	X		X
PCCH		X	
CCCH			X
DCCH			X
DTCH			X

5 MAC procedures

5.1 Random Access procedure

5.1.1 Random Access procedure initialization

The Random Access procedure described in this subclause is initiated by a PDCCH order, by the MAC entity itself, or by RRC for the events in accordance with TS 38.300 [2]. There is only one Random Access procedure ongoing at any point in time in a MAC entity. The Random Access procedure on an SCell shall only be initiated by a PDCCH order with *ra-PreambleIndex* different from 0b000000.

NOTE 1: If the MAC entity receives a request for a new Random Access procedure while another is already ongoing in the MAC entity, it is up to UE implementation whether to continue with the ongoing procedure or start with the new procedure (e.g. for SI request).

RRC configures the following parameters for the Random Access procedure:

- *prach-ConfigurationIndex*: the available set of PRACH occasions for the transmission of the Random Access Preamble;
- *preambleReceivedTargetPower*: initial Random Access Preamble power;
- *rsrp-ThresholdSSB*: an RSRP threshold for the selection of the SSB and corresponding Random Access Preamble and/or PRACH occasion. If the Random Access procedure is initiated for beam failure recovery, *rsrp-ThresholdSSB* used for the selection of the SSB within *candidateBeamRSList* refers to *rsrp-ThresholdSSB* in *BeamFailureRecoveryConfig* IE;
- *rsrp-ThresholdCSI-RS*: an RSRP threshold for the selection of CSI-RS and corresponding Random Access Preamble and/or PRACH occasion. If the Random Access procedure is initiated for beam failure recovery, *rsrp-ThresholdCSI-RS* shall be set to a value calculated by multiplying *rsrp-ThresholdSSB* in *BeamFailureRecoveryConfig* IE by *powerControlOffset* as specified in TS 38.214 [6];
- *rsrp-ThresholdSSB-SUL*: an RSRP threshold for the selection between the NUL carrier and the SUL carrier;
- *candidateBeamRSList*: a list of reference signals (CSI-RS and/or SSB) identifying the candidate beams for recovery and the associated Random Access parameters;
- *powerControlOffset*: a power offset between *rsrp-ThresholdSSB* and *rsrp-ThresholdCSI-RS* to be used when the Random Access procedure is initiated for beam failure recovery;
- *powerRampingStep*: the power-ramping factor;
- *powerRampingStepHighPriority*: the power-ramping factor in case of differentiated Random Access procedure;
- *scalingFactorBI*: a scaling factor for differentiated Random Access procedure;
- *ra-PreambleIndex*: Random Access Preamble;
- *ra-ssb-OccasionMaskIndex*: defines PRACH occasion(s) associated with an SSB in which the MAC entity may transmit a Random Access Preamble (see subclause 7.4);

- *ra-OccasionList*: defines PRACH occasion(s) associated with a CSI-RS in which the MAC entity may transmit a Random Access Preamble;
- *ra-PreambleStartIndex*: the starting index of Random Access Preamble(s) for on-demand SI request;
- *preambleTransMax*: the maximum number of Random Access Preamble transmission;
- *ssb-perRACH-OccasionAndCB-PreamblesPerSSB* (SpCell only): defines the number of SSBs mapped to each PRACH occasion and the number of Random Access Preambles mapped to each SSB;
- if *groupBconfigured* is configured, then Random Access Preambles group B is configured.
 - Amongst the contention-based Random Access Preambles associated with an SSB (as defined in TS 38.213 [6]), the first *numberOfRA-PreamblesGroupA* Random Access Preambles belong to Random Access Preambles group A. The remaining Random Access Preambles associated with the SSB belong to Random Access Preambles group B (if configured).;

NOTE 2: If Random Access Preambles group B is supported by the cell and SSBs are mapped to Random Access Preambles, Random Access Preambles group B is included in each SSB.

- if Random Access Preambles group B is configured:
 - *ra-Msg3SizeGroupA* (per cell): the threshold to determine the groups of Random Access Preambles;
 - *msg3-DeltaPreamble*: $\Delta_{\text{PREAMBLE_Msg3}}$ in TS 38.213 [6];
 - *messagePowerOffsetGroupB*: the power offset for preamble selection;
 - *numberOfRA-PreamblesGroupA* (SpCell only): defines the number of Random Access Preambles in Random Access Preamble group A for each SSB.
- the set of Random Access Preambles and/or PRACH occasions for SI request, if any;
- the set of Random Access Preambles and/or PRACH occasions for beam failure recovery request, if any;
- *ra-ResponseWindow*: the time window to monitor RA response(s) (SpCell only);
- *ra-ContentionResolutionTimer*: the Contention Resolution Timer (SpCell only).

In addition, the following information for related Serving Cell is assumed to be available for UEs:

- if Random Access Preambles group B is configured:
 - if the Serving Cell for the Random Access procedure is configured with *supplementaryUplink*, and SUL carrier is selected for performing Random Access Procedure:
 - $P_{\text{CMAX,f,c}}$ of the SUL carrier as specified in TS 38.101 [10].
 - else:
 - $P_{\text{CMAX,f,c}}$ of the NUL carrier as specified in TS 38.101 [10].

The following UE variables are used for the Random Access procedure:

- *PREAMBLE_INDEX*;
- *PREAMBLE_TRANSMISSION_COUNTER*;
- *PREAMBLE_POWER_RAMPING_COUNTER*;
- *PREAMBLE_POWER_RAMPING_STEP*;
- *PREAMBLE_RECEIVED_TARGET_POWER*;
- *PREAMBLE_BACKOFF*;
- *PCMAX*;

- *SCALING_FACTOR_BI*;
- *TEMPORARY_C-RNTI*.

When the Random Access procedure is initiated on a Serving Cell, the MAC entity shall:

- 1> flush the Msg3 buffer;
- 1> set the *PREAMBLE_TRANSMISSION_COUNTER* to 1;
- 1> set the *PREAMBLE_POWER_RAMPING_COUNTER* to 1;
- 1> set the *PREAMBLE_BACKOFF* to 0 ms;
- 1> if the carrier to use for the Random Access procedure is explicitly signalled:
 - 2> select the signalled carrier for performing Random Access procedure;
 - 2> set the *PCMAX* to $P_{\text{CMAX},f,c}$ of the signalled carrier.
- 1> else if the carrier to use for the Random Access procedure is not explicitly signalled; and
- 1> if the Serving Cell for the Random Access procedure is configured with *supplementaryUplink*; and
- 1> if the RSRP of the downlink pathloss reference is less than *rsrp-ThresholdSSB-SUL*:
 - 2> select the SUL carrier for performing Random Access procedure;
 - 2> set the *PCMAX* to $P_{\text{CMAX},f,c}$ of the SUL carrier.
- 1> else:
 - 2> select the NUL carrier for performing Random Access procedure;
 - 2> set the *PCMAX* to $P_{\text{CMAX},f,c}$ of the NUL carrier.
- 1> set *PREAMBLE_POWER_RAMPING_STEP* to *powerRampingStep*;
- 1> if *powerRampingStepHighPriority* is configured:
 - 2> if the Random Access procedure was initiated for beam failure recovery (as specified in subclause 5.17); or
 - 2> if the Random Access procedure was initiated for handover:
 - 3> set the *PREAMBLE_POWER_RAMPING_STEP* to *powerRampingStepHighPriority*;
- 1> set *SCALING_FACTOR_BI* to 1;
- 1> if *scalingFactorBI* is configured:
 - 2> if the Random Access procedure was initiated for beam failure recovery (as specified in subclause 5.17); or
 - 2> if the Random Access procedure was initiated for handover:
 - 3> set the *SCALING_FACTOR_BI* to *scalingFactorBI*;
- 1> perform the Random Access Resource selection procedure (see subclause 5.1.2).

5.1.2 Random Access Resource selection

The MAC entity shall:

- 1> if the Random Access procedure was initiated for beam failure recovery (as specified in subclause 5.17); and
- 1> if the *beamFailureRecoveryTimer* (in subclause 5.17) is either running or not configured; and
- 1> if the contention-free Random Access Resources for beam failure recovery request associated with any of the SSBs and/or CSI-RSs have been explicitly provided by RRC; and

- 1> if at least one of the SSBs with SS-RSRP above $rsrp\text{-}ThresholdSSB$ amongst the SSBs in *candidateBeamRSList* or the CSI-RSs with CSI-RSRP above $rsrp\text{-}ThresholdCSI\text{-}RS$ amongst the CSI-RSs in *candidateBeamRSList* is available:
 - 2> select an SSB with SS-RSRP above $rsrp\text{-}ThresholdSSB$ amongst the SSBs in *candidateBeamRSList* or a CSI-RS with CSI-RSRP above $rsrp\text{-}ThresholdCSI\text{-}RS$ amongst the CSI-RSs in *candidateBeamRSList*;
 - 2> if CSI-RS is selected, and there is no *ra-PreambleIndex* associated with the selected CSI-RS:
 - 3> set the *PREAMBLE_INDEX* to a *ra-PreambleIndex* corresponding to the SSB in *candidateBeamRSList* which is quasi-collocated with the selected CSI-RS as specified in TS 38.214 [7].
 - 2> else:
 - 3> set the *PREAMBLE_INDEX* to a *ra-PreambleIndex* corresponding to the selected SSB or CSI-RS from the set of Random Access Preambles for beam failure recovery request.
- 1> else if the *ra-PreambleIndex* has been explicitly provided by PDCCH; and
- 1> if the *ra-PreambleIndex* is not 0b000000:
 - 2> set the *PREAMBLE_INDEX* to the signalled *ra-PreambleIndex*;
 - 2> select the SSB signalled by PDCCH.
- 1> else if the contention-free Random Access Resources associated with SSBs have been explicitly provided by RRC and at least one SSB with SS-RSRP above $rsrp\text{-}ThresholdSSB$ amongst the associated SSBs is available:
 - 2> select an SSB with SS-RSRP above $rsrp\text{-}ThresholdSSB$ amongst the associated SSBs;
 - 2> set the *PREAMBLE_INDEX* to a *ra-PreambleIndex* corresponding to the selected SSB.
- 1> else if the contention-free Random Access Resources associated with CSI-RSs have been explicitly provided by RRC and at least one CSI-RS with CSI-RSRP above $rsrp\text{-}ThresholdCSI\text{-}RS$ amongst the associated CSI-RSs is available:
 - 2> select a CSI-RS with CSI-RSRP above $rsrp\text{-}ThresholdCSI\text{-}RS$ amongst the associated CSI-RSs;
 - 2> set the *PREAMBLE_INDEX* to a *ra-PreambleIndex* corresponding to the selected CSI-RS.
- 1> else if the Random Access procedure was initiated for SI request (as specified in TS 38.331 [5]); and
- 1> if the Random Access Resources for SI request have been explicitly provided by RRC:
 - 2> if at least one of the SSBs with SS-RSRP above $rsrp\text{-}ThresholdSSB$ is available:
 - 3> select an SSB with SS-RSRP above $rsrp\text{-}ThresholdSSB$.
 - 2> else:
 - 3> select any SSB.
 - 2> select a Random Access Preamble corresponding to the selected SSB, from the Random Access Preamble(s) determined according to *ra-PreambleStartIndex* as specified in TS 38.331 [5];
 - 2> set the *PREAMBLE_INDEX* to selected Random Access Preamble.
- 1> else (i.e. for the contention-based Random Access preamble selection):
 - 2> if at least one of the SSBs with SS-RSRP above $rsrp\text{-}ThresholdSSB$ is available:
 - 3> select an SSB with SS-RSRP above $rsrp\text{-}ThresholdSSB$.
 - 2> else:
 - 3> select any SSB.
 - 2> if Msg3 has not yet been transmitted:

- 3> if Random Access Preambles group B is configured:
 - 4> if the potential Msg3 size (UL data available for transmission plus MAC header and, where required, MAC CEs) is greater than $ra\text{-}Msg3\text{SizeGroupA}$ and the pathloss is less than $PCMAX$ (of the Serving Cell performing the Random Access Procedure) – $preambleReceivedTargetPower - msg3\text{-}DeltaPreamble - messagePowerOffsetGroupB$; or
 - 4> if the Random Access procedure was initiated for the CCCH logical channel and the CCCH SDU size plus MAC subheader is greater than $ra\text{-}Msg3\text{SizeGroupA}$:
 - 5> select the Random Access Preambles group B.
 - 4> else:
 - 5> select the Random Access Preambles group A.
- 3> else:
 - 4> select the Random Access Preambles group A.
- 2> else (i.e. Msg3 is being retransmitted):
 - 3> select the same group of Random Access Preambles as was used for the Random Access Preamble transmission attempt corresponding to the first transmission of Msg3.
- 2> if the association between Random Access Preambles and SSBs is configured:
 - 3> select a Random Access Preamble randomly with equal probability from the Random Access Preambles associated with the selected SSB and the selected Random Access Preambles group.
- 2> else:
 - 3> select a Random Access Preamble randomly with equal probability from the Random Access Preambles within the selected Random Access Preambles group.
- 2> set the *PREAMBLE_INDEX* to the selected Random Access Preamble.
- 1> if the Random Access procedure was initiated for SI request (as specified in TS 38.331 [5]); and
- 1> if *ra-AssociationPeriodIndex* and *si-RequestPeriod* are configured:
 - 2> determine the next available PRACH occasion from the PRACH occasions corresponding to the selected SSB in the association period given by *ra-AssociationPeriodIndex* in the *si-RequestPeriod* permitted by the restrictions given by the *ra-ssb-OccasionMaskIndex* (the MAC entity shall select a PRACH occasion randomly with equal probability amongst the consecutive PRACH occasions according to subclause 8.1 of TS 38.213 [6] corresponding to the selected SSB).
- 1> else if an SSB is selected above:
 - 2> determine the next available PRACH occasion from the PRACH occasions corresponding to the selected SSB permitted by the restrictions given by the *ra-ssb-OccasionMaskIndex* if configured (the MAC entity shall select a PRACH occasion randomly with equal probability amongst the consecutive PRACH occasions according to subclause 8.1 of TS 38.213 [6], corresponding to the selected SSB; the MAC entity may take into account the possible occurrence of measurement gaps when determining the next available PRACH occasion corresponding to the selected SSB).
- 1> else if a CSI-RS is selected above:
 - 2> if there is no contention-free Random Access Resource associated with the selected CSI-RS:
 - 3> determine the next available PRACH occasion from the PRACH occasions, permitted by the restrictions given by the *ra-ssb-OccasionMaskIndex* if configured, corresponding to the SSB in *candidateBeamRSList* which is quasi-collocated with the selected CSI-RS as specified in TS 38.214 [7] (the MAC entity may take into account the possible occurrence of measurement gaps when determining the next available PRACH occasion corresponding to the SSB which is quasi-collocated with the selected CSI-RS).
 - 2> else:

- 3> determine the next available PRACH occasion from the PRACH occasions in *ra-OccasionList* corresponding to the selected CSI-RS (the MAC entity shall select a PRACH occasion randomly with equal probability amongst the PRACH occasions occurring simultaneously but on different subcarriers, corresponding to the selected CSI-RS; the MAC entity may take into account the possible occurrence of measurement gaps when determining the next available PRACH occasion corresponding to the selected CSI-RS).
 - 1> perform the Random Access Preamble transmission procedure (see subclause 5.1.3).
- NOTE: When the UE determines if there is an SSB with SS-RSRP above *rsrp-ThresholdSSB* or a CSI-RS with CSI-RSRP above *rsrp-ThresholdCSI-RS*, the UE uses the latest unfiltered L1-RSRP measurement.

5.1.3 Random Access Preamble transmission

The MAC entity shall, for each Random Access Preamble:

- 1> if *PREAMBLE_TRANSMISSION_COUNTER* is greater than one; and
- 1> if the notification of suspending power ramping counter has not been received from lower layers; and
- 1> if SSB selected is not changed (i.e. same as the previous Random Access Preamble transmission):
 - 2> increment *PREAMBLE_POWER_RAMPING_COUNTER* by 1.
- 1> select the value of *DELTA_PREAMBLE* according to subclause 7.3;
- 1> set *PREAMBLE_RECEIVED_TARGET_POWER* to $\text{preambleReceivedTargetPower} + \text{DELTA_PREAMBLE} + (\text{PREAMBLE_POWER_RAMPING_COUNTER} - 1) \times \text{PREAMBLE_POWER_RAMPING_STEP}$;
- 1> except for contention-free Random Access Preamble for beam failure recovery request, compute the RA-RNTI associated with the PRACH occasion in which the Random Access Preamble is transmitted;
- 1> instruct the physical layer to transmit the Random Access Preamble using the selected PRACH, corresponding RA-RNTI (if available), *PREAMBLE_INDEX* and *PREAMBLE_RECEIVED_TARGET_POWER*.

The RA-RNTI associated with the PRACH in which the Random Access Preamble is transmitted, is computed as:

$$\text{RA-RNTI} = 1 + \text{s_id} + 14 \times \text{t_id} + 14 \times 80 \times \text{f_id} + 14 \times 80 \times 8 \times \text{ul_carrier_id}$$

where *s_id* is the index of the first OFDM symbol of the specified PRACH ($0 \leq \text{s_id} < 14$), *t_id* is the index of the first slot of the specified PRACH in a system frame ($0 \leq \text{t_id} < 80$), *f_id* is the index of the specified PRACH in the frequency domain ($0 \leq \text{f_id} < 8$), and *ul_carrier_id* is the UL carrier used for Msg1 transmission (0 for NUL carrier, and 1 for SUL carrier).

5.1.4 Random Access Response reception

Once the Random Access Preamble is transmitted and regardless of the possible occurrence of a measurement gap, the MAC entity shall:

- 1> if the contention-free Random Access Preamble for beam failure recovery request was transmitted by the MAC entity:
 - 2> start the *ra-ResponseWindow* configured in *BeamFailureRecoveryConfig* at the first PDCCH occasion as specified in TS 38.213 [6] from the end of the Random Access Preamble transmission;
 - 2> monitor the PDCCH of the SpCell for response to beam failure recovery request identified by the C-RNTI while *ra-ResponseWindow* is running.
- 1> else:
 - 2> start the *ra-ResponseWindow* configured in *RACH-ConfigCommon* at the first PDCCH occasion as specified in TS 38.213 [6] from the end of the Random Access Preamble transmission;
 - 2> monitor the PDCCH of the SpCell for Random Access Response(s) identified by the RA-RNTI while the *ra-ResponseWindow* is running.

- 1> if notification of a reception of a PDCCH transmission is received from lower layers on the Serving Cell where the preamble was transmitted; and
- 1> if PDCCH transmission is addressed to the C-RNTI; and
- 1> if the contention-free Random Access Preamble for beam failure recovery request was transmitted by the MAC entity:
 - 2> consider the Random Access procedure successfully completed.
- 1> else if a downlink assignment has been received on the PDCCH for the RA-RNTI and the received TB is successfully decoded:
 - 2> if the Random Access Response contains a MAC subPDU with Backoff Indicator:
 - 3> set the *PREAMBLE_BACKOFF* to value of the BI field of the MAC subPDU using Table 7.2-1, multiplied with *SCALING_FACTOR_BI*.
 - 2> else:
 - 3> set the *PREAMBLE_BACKOFF* to 0 ms.
 - 2> if the Random Access Response contains a MAC subPDU with Random Access Preamble identifier corresponding to the transmitted *PREAMBLE_INDEX* (see subclause 5.1.3):
 - 3> consider this Random Access Response reception successful.
 - 2> if the Random Access Response reception is considered successful:
 - 3> if the Random Access Response includes a MAC subPDU with RAPID only:
 - 4> consider this Random Access procedure successfully completed;
 - 4> indicate the reception of an acknowledgement for SI request to upper layers.
 - 3> else:
 - 4> apply the following actions for the Serving Cell where the Random Access Preamble was transmitted:
 - 5> process the received Timing Advance Command (see subclause 5.2);
 - 5> indicate the *preambleReceivedTargetPower* and the amount of power ramping applied to the latest Random Access Preamble transmission to lower layers (i.e. $(PREAMBLE_POWER_RAMPING_COUNTER - 1) \times PREAMBLE_POWER_RAMPING_STEP$);
 - 5> if the Serving Cell for the Random Access procedure is SRS-only SCell:
 - 6> ignore the received UL grant.
 - 5> else:
 - 6> process the received UL grant value and indicate it to the lower layers.
 - 4> if the Random Access Preamble was not selected by the MAC entity among the contention-based Random Access Preamble(s):
 - 5> consider the Random Access procedure successfully completed.
 - 4> else:
 - 5> set the *TEMPORARY_C-RNTI* to the value received in the Random Access Response;
 - 5> if this is the first successfully received Random Access Response within this Random Access procedure:
 - 6> if the transmission is not being made for the CCCH logical channel:

- 7> indicate to the Multiplexing and assembly entity to include a C-RNTI MAC CE in the subsequent uplink transmission.
- 6> obtain the MAC PDU to transmit from the Multiplexing and assembly entity and store it in the Msg3 buffer.
- 1> if *ra-ResponseWindow* configured in *RACH-ConfigCommon* expires, and if the Random Access Response containing Random Access Preamble identifiers that matches the transmitted *PREAMBLE_INDEX* has not been received; or
- 1> if *ra-ResponseWindow* configured in *BeamFailureRecoveryConfig* expires and if the PDCCH addressed to the C-RNTI has not been received on the Serving Cell where the preamble was transmitted:
 - 2> consider the Random Access Response reception not successful;
 - 2> increment *PREAMBLE_TRANSMISSION_COUNTER* by 1;
 - 2> if *PREAMBLE_TRANSMISSION_COUNTER* = *preambleTransMax* + 1:
 - 3> if the Random Access Preamble is transmitted on the SpCell:
 - 4> indicate a Random Access problem to upper layers;
 - 4> if this Random Access procedure was triggered for SI request:
 - 5> consider the Random Access procedure unsuccessfully completed.
 - 3> else if the Random Access Preamble is transmitted on a SCell:
 - 4> consider the Random Access procedure unsuccessfully completed.
 - 2> if the Random Access procedure is not completed:
 - 3> select a random backoff time according to a uniform distribution between 0 and the *PREAMBLE_BACKOFF*;
 - 3> if the criteria (as defined in subclause 5.1.2) to select contention-free Random Access Resources is met during the backoff time:
 - 4> perform the Random Access Resource selection procedure (see subclause 5.1.2);
 - 3> else:
 - 4> perform the Random Access Resource selection procedure (see subclause 5.1.2) after the backoff time.

The MAC entity may stop *ra-ResponseWindow* (and hence monitoring for Random Access Response(s)) after successful reception of a Random Access Response containing Random Access Preamble identifiers that matches the transmitted *PREAMBLE_INDEX*.

HARQ operation is not applicable to the Random Access Response transmission.

5.1.5 Contention Resolution

Once Msg3 is transmitted, the MAC entity shall:

- 1> start the *ra-ContentionResolutionTimer* and restart the *ra-ContentionResolutionTimer* at each HARQ retransmission in the first symbol after the end of the Msg3 transmission;
- 1> monitor the PDCCH while the *ra-ContentionResolutionTimer* is running regardless of the possible occurrence of a measurement gap;
- 1> if notification of a reception of a PDCCH transmission of the SpCell is received from lower layers:
 - 2> if the C-RNTI MAC CE was included in Msg3:
 - 3> if the Random Access procedure was initiated by the MAC sublayer itself or by the RRC sublayer and the PDCCH transmission is addressed to the C-RNTI and contains a UL grant for a new transmission; or

- 3> if the Random Access procedure was initiated by a PDCCH order and the PDCCH transmission is addressed to the C-RNTI; or
- 3> if the Random Access procedure was initiated for beam failure recovery (as specified in subclause 5.17) and the PDCCH transmission is addressed to the C-RNTI:
 - 4> consider this Contention Resolution successful;
 - 4> stop *ra-ContentionResolutionTimer*;
 - 4> discard the *TEMPORARY_C-RNTI*;
 - 4> consider this Random Access procedure successfully completed.
- 2> else if the CCCH SDU was included in Msg3 and the PDCCH transmission is addressed to its *TEMPORARY_C-RNTI*:
 - 3> if the MAC PDU is successfully decoded:
 - 4> stop *ra-ContentionResolutionTimer*;
 - 4> if the MAC PDU contains a UE Contention Resolution Identity MAC CE; and
 - 4> if the UE Contention Resolution Identity in the MAC CE matches the CCCH SDU transmitted in Msg3:
 - 5> consider this Contention Resolution successful and finish the disassembly and demultiplexing of the MAC PDU;
 - 5> if this Random Access procedure was initiated for SI request:
 - 6> indicate the reception of an acknowledgement for SI request to upper layers.
 - 5> else:
 - 6> set the C-RNTI to the value of the *TEMPORARY_C-RNTI*;
 - 5> discard the *TEMPORARY_C-RNTI*;
 - 5> consider this Random Access procedure successfully completed.
 - 4> else:
 - 5> discard the *TEMPORARY_C-RNTI*;
 - 5> consider this Contention Resolution not successful and discard the successfully decoded MAC PDU.
- 1> if *ra-ContentionResolutionTimer* expires:
 - 2> discard the *TEMPORARY_C-RNTI*;
 - 2> consider the Contention Resolution not successful.
- 1> if the Contention Resolution is considered not successful:
 - 2> flush the HARQ buffer used for transmission of the MAC PDU in the Msg3 buffer;
 - 2> increment *PREAMBLE_TRANSMISSION_COUNTER* by 1;
 - 2> if *PREAMBLE_TRANSMISSION_COUNTER* = *preambleTransMax* + 1:
 - 3> indicate a Random Access problem to upper layers.
 - 3> if this Random Access procedure was triggered for SI request:
 - 4> consider the Random Access procedure unsuccessfully completed.

- 2> if the Random Access procedure is not completed:
 - 3> select a random backoff time according to a uniform distribution between 0 and the *PREAMBLE_BACKOFF*;
 - 3> if the criteria (as defined in subclause 5.1.2) to select contention-free Random Access Resources is met during the backoff time:
 - 4> perform the Random Access Resource selection procedure (see subclause 5.1.2);
 - 3> else:
 - 4> perform the Random Access Resource selection procedure (see subclause 5.1.2) after the backoff time.

5.1.6 Completion of the Random Access procedure

Upon completion of the Random Access procedure, the MAC entity shall:

- 1> discard explicitly signalled contention-free Random Access Resources except contention-free Random Access Resources for beam failure recovery request, if any;
- 1> flush the HARQ buffer used for transmission of the MAC PDU in the Msg3 buffer.

5.2 Maintenance of Uplink Time Alignment

RRC configures the following parameters for the maintenance of UL time alignment:

- *timeAlignmentTimer* (per TAG) which controls how long the MAC entity considers the Serving Cells belonging to the associated TAG to be uplink time aligned.

The MAC entity shall:

- 1> when a Timing Advance Command MAC CE is received, and if an N_{TA} (as defined in TS 38.211 [8]) has been maintained with the indicated TAG:
 - 2> apply the Timing Advance Command for the indicated TAG;
 - 2> start or restart the *timeAlignmentTimer* associated with the indicated TAG.
- 1> when a Timing Advance Command is received in a Random Access Response message for a Serving Cell belonging to a TAG:
 - 2> if the Random Access Preamble was not selected by the MAC entity among the contention-based Random Access Preamble:
 - 3> apply the Timing Advance Command for this TAG;
 - 3> start or restart the *timeAlignmentTimer* associated with this TAG.
 - 2> else if the *timeAlignmentTimer* associated with this TAG is not running:
 - 3> apply the Timing Advance Command for this TAG;
 - 3> start the *timeAlignmentTimer* associated with this TAG;
 - 3> when the Contention Resolution is considered not successful as described in subclause 5.1.5; or
 - 3> when the Contention Resolution is considered successful for SI request as described in subclause 5.1.5, after transmitting HARQ feedback for MAC PDU including UE Contention Resolution Identity MAC CE:
 - 4> stop *timeAlignmentTimer* associated with this TAG.
 - 2> else:

- 3> ignore the received Timing Advance Command.
- 1> when a *timeAlignmentTimer* expires:
 - 2> if the *timeAlignmentTimer* is associated with the PTAG:
 - 3> flush all HARQ buffers for all Serving Cells;
 - 3> notify RRC to release PUCCH for all Serving Cells, if configured;
 - 3> notify RRC to release SRS for all Serving Cells, if configured;
 - 3> clear any configured downlink assignments and configured uplink grants;
 - 3> clear any PUSCH resource for semi-persistent CSI reporting;
 - 3> consider all running *timeAlignmentTimers* as expired;
 - 3> maintain N_{TA} (defined in TS 38.211 [8]) of all TAGs.
 - 2> else if the *timeAlignmentTimer* is associated with an STAG, then for all Serving Cells belonging to this TAG:
 - 3> flush all HARQ buffers;
 - 3> notify RRC to release PUCCH, if configured;
 - 3> notify RRC to release SRS, if configured;
 - 3> clear any configured downlink assignments and configured uplink grants;
 - 3> clear any PUSCH resource for semi-persistent CSI reporting;
 - 3> maintain N_{TA} (defined in TS 38.211 [8]) of this TAG.

When the MAC entity stops uplink transmissions for an SCell due to the fact that the maximum uplink transmission timing difference between TAGs of the MAC entity or the maximum uplink transmission timing difference between TAGs of any MAC entity of the UE is exceeded, the MAC entity considers the *timeAlignmentTimer* associated with the SCell as expired.

The MAC entity shall not perform any uplink transmission on a Serving Cell except the Random Access Preamble transmission when the *timeAlignmentTimer* associated with the TAG to which this Serving Cell belongs is not running. Furthermore, when the *timeAlignmentTimer* associated with the PTAG is not running, the MAC entity shall not perform any uplink transmission on any Serving Cell except the Random Access Preamble transmission on the SpCell.

5.3 DL-SCH data transfer

5.3.1 DL Assignment reception

Downlink assignments received on the PDCCH both indicate that there is a transmission on a DL-SCH for a particular MAC entity and provide the relevant HARQ information.

When the MAC entity has a C-RNTI, Temporary C-RNTI, or CS-RNTI, the MAC entity shall for each PDCCH occasion during which it monitors PDCCH and for each Serving Cell:

- 1> if a downlink assignment for this PDCCH occasion and this Serving Cell has been received on the PDCCH for the MAC entity's C-RNTI, or Temporary C-RNTI:
 - 2> if this is the first downlink assignment for this Temporary C-RNTI:
 - 3> consider the NDI to have been toggled.
 - 2> if the downlink assignment is for the MAC entity's C-RNTI, and if the previous downlink assignment indicated to the HARQ entity of the same HARQ process was either a downlink assignment received for the MAC entity's CS-RNTI or a configured downlink assignment:

- 3> consider the NDI to have been toggled regardless of the value of the NDI.
- 2> indicate the presence of a downlink assignment and deliver the associated HARQ information to the HARQ entity.
- 1> else if a downlink assignment for this PDCCH occasion has been received for this Serving Cell on the PDCCH for the MAC entity's CS-RNTI:
 - 2> if the NDI in the received HARQ information is 1:
 - 3> consider the NDI for the corresponding HARQ process not to have been toggled;
 - 3> indicate the presence of a downlink assignment for this Serving Cell and deliver the associated HARQ information to the HARQ entity.
 - 2> if the NDI in the received HARQ information is 0:
 - 3> if PDCCH contents indicate SPS deactivation:
 - 4> clear the configured downlink assignment for this Serving Cell (if any);
 - 4> if the *timeAlignmentTimer*, associated with the TAG containing the Serving Cell on which the HARQ feedback is to be transmitted, is running:
 - 5> indicate a positive acknowledgement for the SPS deactivation to the physical layer.
 - 3> else if PDCCH content indicates SPS activation:
 - 4> store the downlink assignment for this Serving Cell and the associated HARQ information as configured downlink assignment;
 - 4> initialise or re-initialise the configured downlink assignment for this Serving Cell to start in the associated PDSCH duration and to recur according to rules in subclause 5.8.1;
 - 4> set the HARQ Process ID to the HARQ Process ID associated with this PDSCH duration;
 - 4> consider the NDI bit for the corresponding HARQ process to have been toggled;
 - 4> indicate the presence of a configured downlink assignment for this Serving Cell and deliver the stored HARQ information to the HARQ entity.

For each Serving Cell and each configured downlink assignment, if configured and activated, the MAC entity shall:

- 1> if the PDSCH duration of the configured downlink assignment does not overlap with the PDSCH duration of a downlink assignment received on the PDCCH for this Serving Cell:
 - 2> instruct the physical layer to receive, in this PDSCH duration, transport block on the DL-SCH according to the configured downlink assignment and to deliver it to the HARQ entity;
 - 2> set the HARQ Process ID to the HARQ Process ID associated with this PDSCH duration;
 - 2> consider the NDI bit to have been toggled;
 - 2> indicate the presence of a configured downlink assignment and deliver the stored HARQ information to the HARQ entity.

For configured downlink assignments, the HARQ Process ID associated with the slot where the DL transmission starts is derived from the following equation:

$$\text{HARQ Process ID} = [\text{floor}(\text{CURRENT_slot} \times 10 / (\text{numberOfSlotsPerFrame} \times \text{periodicity}))] \text{ modulo } n_{\text{rofHARQ-Processes}}$$

where $\text{CURRENT_slot} = [(\text{SFN} \times \text{numberOfSlotsPerFrame}) + \text{slot number in the frame}]$ and *numberOfSlotsPerFrame* refers to the number of consecutive slots per frame as specified in TS 38.211 [8].

When the MAC entity needs to read BCCH, the MAC entity may, based on the scheduling information from RRC:

- 1> if a downlink assignment for this PDCCH occasion has been received on the PDCCH for the SI-RNTI;

- 2> indicate a downlink assignment and redundancy version for the dedicated broadcast HARQ process to the HARQ entity.

5.3.2 HARQ operation

5.3.2.1 HARQ Entity

The MAC entity includes a HARQ entity for each Serving Cell, which maintains a number of parallel HARQ processes. Each HARQ process is associated with a HARQ process identifier. The HARQ entity directs HARQ information and associated TBs received on the DL-SCH to the corresponding HARQ processes (see subclause 5.3.2.2).

The number of parallel DL HARQ processes per HARQ entity is specified in TS 38.214 [7]. The dedicated broadcast HARQ process is used for BCCH.

The HARQ process supports one TB when the physical layer is not configured for downlink spatial multiplexing. The HARQ process supports one or two TBs when the physical layer is configured for downlink spatial multiplexing.

When the MAC entity is configured with *pdsch-AggregationFactor* > 1, the parameter *pdsch-AggregationFactor* provides the number of transmissions of a TB within a bundle of the dynamic downlink assignment. Bundling operation relies on the HARQ entity for invoking the same HARQ process for each transmission that is part of the same bundle. After the initial transmission, *pdsch-AggregationFactor* – 1 HARQ retransmissions follow within a bundle.

The MAC entity shall:

- 1> if a downlink assignment has been indicated:
 - 2> allocate the TB(s) received from the physical layer and the associated HARQ information to the HARQ process indicated by the associated HARQ information.
- 1> if a downlink assignment has been indicated for the broadcast HARQ process:
 - 2> allocate the received TB to the broadcast HARQ process.

5.3.2.2 HARQ process

When a transmission takes place for the HARQ process, one or two (in case of downlink spatial multiplexing) TBs and the associated HARQ information are received from the HARQ entity.

For each received TB and associated HARQ information, the HARQ process shall:

- 1> if the NDI, when provided, has been toggled compared to the value of the previous received transmission corresponding to this TB; or
- 1> if the HARQ process is equal to the broadcast process, and this is the first received transmission for the TB according to the system information schedule indicated by RRC; or
- 1> if this is the very first received transmission for this TB (i.e. there is no previous NDI for this TB):
 - 2> consider this transmission to be a new transmission.
- 1> else:
 - 2> consider this transmission to be a retransmission.

The MAC entity then shall:

- 1> if this is a new transmission:
 - 2> attempt to decode the received data.
- 1> else if this is a retransmission:
 - 2> if the data for this TB has not yet been successfully decoded:

- 3> instruct the physical layer to combine the received data with the data currently in the soft buffer for this TB and attempt to decode the combined data.
- 1> if the data which the MAC entity attempted to decode was successfully decoded for this TB; or
- 1> if the data for this TB was successfully decoded before:
 - 2> if the HARQ process is equal to the broadcast process:
 - 3> deliver the decoded MAC PDU to upper layers.
 - 2> else if this is the first successful decoding of the data for this TB:
 - 3> deliver the decoded MAC PDU to the disassembly and demultiplexing entity.
- 1> else:
 - 2> instruct the physical layer to replace the data in the soft buffer for this TB with the data which the MAC entity attempted to decode.
- 1> if the HARQ process is associated with a transmission indicated with a Temporary C-RNTI and the Contention Resolution is not yet successful (see subclause 5.1.5); or
- 1> if the HARQ process is equal to the broadcast process; or
- 1> if the *timeAlignmentTimer*, associated with the TAG containing the Serving Cell on which the HARQ feedback is to be transmitted, is stopped or expired:
 - 2> not instruct the physical layer to generate acknowledgement(s) of the data in this TB.
- 1> else:
 - 2> instruct the physical layer to generate acknowledgement(s) of the data in this TB.

The MAC entity shall ignore NDI received in all downlink assignments on PDCCH for its Temporary C-RNTI when determining if NDI on PDCCH for its C-RNTI has been toggled compared to the value in the previous transmission.

NOTE: If the MAC entity receives a retransmission with a TB size different from the last TB size signalled for this TB, the UE behavior is left up to UE implementation.

5.3.3 Disassembly and demultiplexing

The MAC entity shall disassemble and demultiplex a MAC PDU as defined in subclause 6.1.2.

5.4 UL-SCH data transfer

5.4.1 UL Grant reception

Uplink grant is either received dynamically on the PDCCH, in a Random Access Response, or configured semi-persistently by RRC. The MAC entity shall have an uplink grant to transmit on the UL-SCH. To perform the requested transmissions, the MAC layer receives HARQ information from lower layers.

If the MAC entity has a C-RNTI, a Temporary C-RNTI, or CS-RNTI, the MAC entity shall for each PDCCH occasion and for each Serving Cell belonging to a TAG that has a running *timeAlignmentTimer* and for each grant received for this PDCCH occasion:

- 1> if an uplink grant for this Serving Cell has been received on the PDCCH for the MAC entity's C-RNTI or Temporary C-RNTI; or
- 1> if an uplink grant has been received in a Random Access Response:
 - 2> if the uplink grant is for MAC entity's C-RNTI and if the previous uplink grant delivered to the HARQ entity for the same HARQ process was either an uplink grant received for the MAC entity's CS-RNTI or a configured uplink grant:

- 3> consider the NDI to have been toggled for the corresponding HARQ process regardless of the value of the NDI.
- 2> if the uplink grant is for MAC entity's C-RNTI, and the identified HARQ process is configured for a configured uplink grant:
 - 3> start or restart the *configuredGrantTimer* for the corresponding HARQ process, if configured.
- 2> deliver the uplink grant and the associated HARQ information to the HARQ entity.
- 1> else if an uplink grant for this PDCCH occasion has been received for this Serving Cell on the PDCCH for the MAC entity's CS-RNTI:
 - 2> if the NDI in the received HARQ information is 1:
 - 3> consider the NDI for the corresponding HARQ process not to have been toggled;
 - 3> start or restart the *configuredGrantTimer* for the corresponding HARQ process, if configured;
 - 3> deliver the uplink grant and the associated HARQ information to the HARQ entity.
 - 2> else if the NDI in the received HARQ information is 0:
 - 3> if PDCCH contents indicate configured grant Type 2 deactivation:
 - 4> trigger configured uplink grant confirmation.
 - 3> else if PDCCH contents indicate configured grant Type 2 activation:
 - 4> trigger configured uplink grant confirmation;
 - 4> store the uplink grant for this Serving Cell and the associated HARQ information as configured uplink grant;
 - 4> initialise or re-initialise the configured uplink grant for this Serving Cell to start in the associated PUSCH duration and to recur according to rules in subclause 5.8.2;
 - 4> set the HARQ Process ID to the HARQ Process ID associated with this PUSCH duration;
 - 4> consider the NDI bit for the corresponding HARQ process to have been toggled;
 - 4> stop the *configuredGrantTimer* for the corresponding HARQ process, if running;
 - 4> deliver the configured uplink grant and the associated HARQ information to the HARQ entity.

For each Serving Cell and each configured uplink grant, if configured and activated, the MAC entity shall:

- 1> if the PUSCH duration of the configured uplink grant does not overlap with the PUSCH duration of an uplink grant received on the PDCCH for this Serving Cell:
 - 2> set the HARQ Process ID to the HARQ Process ID associated with this PUSCH duration;
 - 2> if the *configuredGrantTimer* for the corresponding HARQ process is not running:
 - 3> consider the NDI bit for the corresponding HARQ process to have been toggled;
 - 3> deliver the configured uplink grant and the associated HARQ information to the HARQ entity.

For configured uplink grants, the HARQ Process ID associated with the first symbol of a UL transmission is derived from the following equation:

$$\text{HARQ Process ID} = [\text{floor}(\text{CURRENT_symbol}/\text{periodicity})] \text{ modulo } n\text{rofHARQ-Processes}$$

where $\text{CURRENT_symbol} = (\text{SFN} \times \text{numberOfSlotsPerFrame} \times \text{numberOfSymbolsPerSlot} + \text{slot number in the frame} \times \text{numberOfSymbolsPerSlot} + \text{symbol number in the slot})$, and *numberOfSlotsPerFrame* and *numberOfSymbolsPerSlot* refer to the number of consecutive slots per frame and the number of consecutive symbols per slot, respectively as specified in TS 38.211 [8].

NOTE 1: CURRENT_symbol refers to the symbol index of the first transmission occasion of a repetition bundle that takes place.

NOTE 2: A HARQ process is configured for a configured uplink grant if the configured uplink grant is activated and the associated HARQ process ID is less than *nrofHARQ-Processes*.

5.4.2 HARQ operation

5.4.2.1 HARQ Entity

The MAC entity includes a HARQ entity for each Serving Cell with configured uplink (including the case when it is configured with *supplementaryUplink*), which maintains a number of parallel HARQ processes.

The number of parallel UL HARQ processes per HARQ entity is specified in TS 38.214 [7].

Each HARQ process supports one TB.

Each HARQ process is associated with a HARQ process identifier. For UL transmission with UL grant in RA Response, HARQ process identifier 0 is used.

When the MAC entity is configured with *pusch-AggregationFactor* > 1, the parameter *pusch-AggregationFactor* provides the number of transmissions of a TB within a bundle of the dynamic grant. After the initial transmission, *pusch-AggregationFactor* – 1 HARQ retransmissions follow within a bundle. When the MAC entity is configured with *repK* > 1, the parameter *repK* provides the number of transmissions of a TB within a bundle of the configured uplink grant. After the initial transmission, HARQ retransmissions follow within a bundle. For both dynamic grant and configured uplink grant, bundling operation relies on the HARQ entity for invoking the same HARQ process for each transmission that is part of the same bundle. Within a bundle, HARQ retransmissions are triggered without waiting for feedback from previous transmission according to *pusch-AggregationFactor* for a dynamic grant and *repK* for a configured uplink grant, respectively. Each transmission within a bundle is a separate uplink grant after the initial uplink grant within a bundle is delivered to the HARQ entity.

For each transmission within a bundle of the dynamic grant, the sequence of redundancy versions is determined according to subclause 6.1.4 of TS 38.214 [7]. For each transmission within a bundle of the configured uplink grant, the sequence of redundancy versions is determined according to subclause 6.1.2.3 of TS 38.214 [7].

For each uplink grant, the HARQ entity shall:

- 1> identify the HARQ process associated with this grant, and for each identified HARQ process:
 - 2> if the received grant was not addressed to a Temporary C-RNTI on PDCCH, and the NDI provided in the associated HARQ information has been toggled compared to the value in the previous transmission of this TB of this HARQ process; or
 - 2> if the uplink grant was received on PDCCH for the C-RNTI and the HARQ buffer of the identified process is empty; or
 - 2> if the uplink grant was received in a Random Access Response; or
 - 2> if the uplink grant is part of a bundle of the configured uplink grant, and may be used for initial transmission according to subclause 6.1.2.3 of TS 38.214 [7], and if no MAC PDU has been obtained for this bundle:
 - 3> if there is a MAC PDU in the Msg3 buffer and the uplink grant was received in a Random Access Response:
 - 4> obtain the MAC PDU to transmit from the Msg3 buffer.
 - 3> else:
 - 4> obtain the MAC PDU to transmit from the Multiplexing and assembly entity, if any;
 - 3> if a MAC PDU to transmit has been obtained:
 - 4> deliver the MAC PDU and the uplink grant and the HARQ information of the TB to the identified HARQ process;

- 4> instruct the identified HARQ process to trigger a new transmission;
- 4> if the uplink grant is addressed to CS-RNTI; or
- 4> if the uplink grant is a configured uplink grant; or
- 4> if the uplink grant is addressed to C-RNTI, and the identified HARQ process is configured for a configured uplink grant:
 - 5> start or restart the *configuredGrantTimer*, if configured, for the corresponding HARQ process when the transmission is performed.
- 3> else:
 - 4> flush the HARQ buffer of the identified HARQ process.
- 2> else (i.e. retransmission):
 - 3> if the uplink grant received on PDCCH was addressed to CS-RNTI and if the HARQ buffer of the identified process is empty; or
 - 3> if the uplink grant is part of a bundle and if no MAC PDU has been obtained for this bundle; or
 - 3> if the uplink grant is part of a bundle of the configured uplink grant, and the PUSCH of the uplink grant overlaps with a PUSCH of another uplink grant received on the PDCCH for this Serving Cell:
 - 4> ignore the uplink grant.
 - 3> else:
 - 4> deliver the uplink grant and the HARQ information (redundancy version) of the TB to the identified HARQ process;
 - 4> instruct the identified HARQ process to trigger a retransmission;
 - 4> if the uplink grant is addressed to CS-RNTI; or
 - 4> if the uplink grant is addressed to C-RNTI, and the identified HARQ process is configured for a configured uplink grant:
 - 5> start or restart the *configuredGrantTimer*, if configured, for the corresponding HARQ process when the transmission is performed.

When determining if NDI has been toggled compared to the value in the previous transmission the MAC entity shall ignore NDI received in all uplink grants on PDCCH for its Temporary C-RNTI.

5.4.2.2 HARQ process

Each HARQ process is associated with a HARQ buffer.

New transmissions are performed on the resource and with the MCS indicated on either PDCCH, Random Access Response, or RRC. Retransmissions are performed on the resource and, if provided, with the MCS indicated on PDCCH, or on the same resource and with the same MCS as was used for last made transmission attempt within a bundle.

If the HARQ entity requests a new transmission for a TB, the HARQ process shall:

- 1> store the MAC PDU in the associated HARQ buffer;
- 1> store the uplink grant received from the HARQ entity;
- 1> generate a transmission as described below.

If the HARQ entity requests a retransmission for a TB, the HARQ process shall:

- 1> store the uplink grant received from the HARQ entity;

1> generate a transmission as described below.

To generate a transmission for a TB, the HARQ process shall:

- 1> if the MAC PDU was obtained from the Msg3 buffer; or
- 1> if there is no measurement gap at the time of the transmission and, in case of retransmission, the retransmission does not collide with a transmission for a MAC PDU obtained from the Msg3 buffer:
- 2> instruct the physical layer to generate a transmission according to the stored uplink grant.

5.4.3 Multiplexing and assembly

5.4.3.1 Logical Channel Prioritization

5.4.3.1.1 General

The Logical Channel Prioritization (LCP) procedure is applied whenever a new transmission is performed.

RRC controls the scheduling of uplink data by signalling for each logical channel per MAC entity:

- *priority* where an increasing priority value indicates a lower priority level;
- *prioritisedBitRate* which sets the Prioritized Bit Rate (PBR);
- *bucketSizeDuration* which sets the Bucket Size Duration (BSD).

RRC additionally controls the LCP procedure by configuring mapping restrictions for each logical channel:

- *allowedSCS-List* which sets the allowed Subcarrier Spacing(s) for transmission;
- *maxPUSCH-Duration* which sets the maximum PUSCH duration allowed for transmission;
- *configuredGrantType1Allowed* which sets whether a configured grant Type 1 can be used for transmission;
- *allowedServingCells* which sets the allowed cell(s) for transmission.

The following UE variable is used for the Logical channel prioritization procedure:

- B_j which is maintained for each logical channel j .

The MAC entity shall initialize B_j of the logical channel to zero when the logical channel is established.

For each logical channel j , the MAC entity shall:

- 1> increment B_j by the product $PBR \times T$ before every instance of the LCP procedure, where T is the time elapsed since B_j was last incremented;
- 1> if the value of B_j is greater than the bucket size (i.e. $PBR \times BSD$):
- 2> set B_j to the bucket size.

NOTE: The exact moment(s) when the UE updates B_j between LCP procedures is up to UE implementation, as long as B_j is up to date at the time when a grant is processed by LCP.

5.4.3.1.2 Selection of logical channels

The MAC entity shall, when a new transmission is performed:

- 1> select the logical channels for each UL grant that satisfy all the following conditions:
- 2> the set of allowed Subcarrier Spacing index values in *allowedSCS-List*, if configured, includes the Subcarrier Spacing index associated to the UL grant; and

- 2> *maxPUSCH-Duration*, if configured, is larger than or equal to the PUSCH transmission duration associated to the UL grant; and
- 2> *configuredGrantType1Allowed*, if configured, is set to TRUE in case the UL grant is a Configured Grant Type 1; and
- 2> *allowedServingCells*, if configured, includes the Cell information associated to the UL grant. Does not apply to logical channels associated with a DRB configured with PDCP duplication for which PDCP duplication is deactivated.

NOTE: The Subcarrier Spacing index, PUSCH transmission duration and Cell information are included in Uplink transmission information received from lower layers for the corresponding scheduled uplink transmission.

5.4.3.1.3 Allocation of resources

The MAC entity shall, when a new transmission is performed:

- 1> allocate resources to the logical channels as follows:
 - 2> logical channels selected in subclause 5.4.3.1.2 for the UL grant with $B_j > 0$ are allocated resources in a decreasing priority order. If the PBR of a logical channel is set to "infinity", the MAC entity shall allocate resources for all the data that is available for transmission on the logical channel before meeting the PBR of the lower priority logical channel(s);
 - 2> decrement B_j by the total size of MAC SDUs served to logical channel j above;
 - 2> if any resources remain, all the logical channels selected in subclause 5.4.3.1.2 are served in a strict decreasing priority order (regardless of the value of B_j) until either the data for that logical channel or the UL grant is exhausted, whichever comes first. Logical channels configured with equal priority should be served equally.

NOTE: The value of B_j can be negative.

If the MAC entity is requested to simultaneously transmit multiple MAC PDUs, or if the MAC entity receives the multiple UL grants within one or more coinciding PDCCH occasions (i.e. on different Serving Cells), it is up to UE implementation in which order the grants are processed.

The UE shall also follow the rules below during the scheduling procedures above:

- the UE should not segment an RLC SDU (or partially transmitted SDU or retransmitted RLC PDU) if the whole SDU (or partially transmitted SDU or retransmitted RLC PDU) fits into the remaining resources of the associated MAC entity;
- if the UE segments an RLC SDU from the logical channel, it shall maximize the size of the segment to fill the grant of the associated MAC entity as much as possible;
- the UE should maximise the transmission of data;
- if the MAC entity is given a UL grant size that is equal to or larger than 8 bytes while having data available for transmission, the MAC entity shall not transmit only padding BSR and/or padding.

The MAC entity shall not generate a MAC PDU for the HARQ entity if the following conditions are satisfied:

- the MAC entity is configured with *skipUplinkTxDynamic* and the grant indicated to the HARQ entity was addressed to a C-RNTI, or the grant indicated to the HARQ entity is a configured uplink grant; and
- there is no aperiodic CSI requested for this PUSCH transmission as specified in TS 38.212 [9]; and
- the MAC PDU includes zero MAC SDUs; and
- the MAC PDU includes only the periodic BSR and there is no data available for any LCG, or the MAC PDU includes only the padding BSR.

Logical channels shall be prioritised in accordance with the following order (highest priority listed first):

- C-RNTI MAC CE or data from UL-CCCH;

- Configured Grant Confirmation MAC CE;
- MAC CE for BSR, with exception of BSR included for padding;
- Single Entry PHR MAC CE or Multiple Entry PHR MAC CE;
- data from any Logical Channel, except data from UL-CCCH;
- MAC CE for Recommended bit rate query;
- MAC CE for BSR included for padding.

5.4.3.2 Multiplexing of MAC Control Elements and MAC SDUs

The MAC entity shall multiplex MAC CEs and MAC SDUs in a MAC PDU according to subclauses 5.4.3.1 and 6.1.2.

5.4.4 Scheduling Request

The Scheduling Request (SR) is used for requesting UL-SCH resources for new transmission.

The MAC entity may be configured with zero, one, or more SR configurations. An SR configuration consists of a set of PUCCH resources for SR across different BWPs and cells. For a logical channel, at most one PUCCH resource for SR is configured per BWP.

Each SR configuration corresponds to one or more logical channels. Each logical channel may be mapped to zero or one SR configuration, which is configured by RRC. The SR configuration of the logical channel that triggered the BSR (subclause 5.4.5) (if such a configuration exists) is considered as corresponding SR configuration for the triggered SR.

RRC configures the following parameters for the scheduling request procedure:

- *sr-ProhibitTimer* (per SR configuration);
- *sr-TransMax* (per SR configuration).

The following UE variables are used for the scheduling request procedure:

- *SR_COUNTER* (per SR configuration).

If an SR is triggered and there are no other SRs pending corresponding to the same SR configuration, the MAC entity shall set the *SR_COUNTER* of the corresponding SR configuration to 0.

When an SR is triggered, it shall be considered as pending until it is cancelled. All pending SR(s) triggered prior to the MAC PDU assembly shall be cancelled and each respective *sr-ProhibitTimer* shall be stopped when the MAC PDU is transmitted and this PDU includes a BSR MAC CE which contains buffer status up to (and including) the last event that triggered a BSR (see subclause 5.4.5) prior to the MAC PDU assembly. All pending SR(s) shall be cancelled and each respective *sr-ProhibitTimer* shall be stopped when the UL grant(s) can accommodate all pending data available for transmission.

Only PUCCH resources on a BWP which is active at the time of SR transmission occasion are considered valid.

As long as at least one SR is pending, the MAC entity shall for each pending SR:

- 1> if the MAC entity has no valid PUCCH resource configured for the pending SR:
 - 2> initiate a Random Access procedure (see subclause 5.1) on the SpCell and cancel the pending SR.
- 1> else, for the SR configuration corresponding to the pending SR:
 - 2> when the MAC entity has an SR transmission occasion on the valid PUCCH resource for SR configured; and
 - 2> if *sr-ProhibitTimer* is not running at the time of the SR transmission occasion; and
 - 2> if the PUCCH resource for the SR transmission occasion does not overlap with a measurement gap; and
 - 2> if the PUCCH resource for the SR transmission occasion does not overlap with a UL-SCH resource:

- 3> if *SR_COUNTER* < *sr-TransMax*:
- 4> increment *SR_COUNTER* by 1;
 - 4> instruct the physical layer to signal the SR on one valid PUCCH resource for SR;
 - 4> start the *sr-ProhibitTimer*.
- 3> else:
- 4> notify RRC to release PUCCH for all Serving Cells;
 - 4> notify RRC to release SRS for all Serving Cells;
 - 4> clear any configured downlink assignments and uplink grants;
 - 4> clear any PUSCH resources for semi-persistent CSI reporting;
 - 4> initiate a Random Access procedure (see subclause 5.1) on the SpCell and cancel all pending SRs.

NOTE: The selection of which valid PUCCH resource for SR to signal SR on when the MAC entity has more than one overlapping valid PUCCH resource for the SR transmission occasion is left to UE implementation.

The MAC entity may stop, if any, ongoing Random Access procedure due to a pending SR which has no valid PUCCH resources configured, which was initiated by MAC entity prior to the MAC PDU assembly. Such a Random Access procedure may be stopped when the MAC PDU is transmitted using a UL grant other than a UL grant provided by Random Access Response, and this PDU includes a BSR MAC CE which contains buffer status up to (and including) the last event that triggered a BSR (see subclause 5.4.5) prior to the MAC PDU assembly, or when the UL grant(s) can accommodate all pending data available for transmission.

5.4.5 Buffer Status Reporting

The Buffer Status reporting (BSR) procedure is used to provide the serving gNB with information about UL data volume in the MAC entity.

RRC configures the following parameters to control the BSR:

- *periodicBSR-Timer*;
- *retxBSR-Timer*;
- *logicalChannelSR-DelayTimerApplied*;
- *logicalChannelSR-DelayTimer*;
- *logicalChannelSR-Mask*;
- *logicalChannelGroup*.

Each logical channel may be allocated to an LCG using the *logicalChannelGroup*. The maximum number of LCGs is eight.

The MAC entity determines the amount of UL data available for a logical channel according to the data volume calculation procedure in TSs 38.322 and 38.323 [3] [4].

A BSR shall be triggered if any of the following events occur:

- the MAC entity has new UL data available for a logical channel which belongs to an LCG; and either
 - the new UL data belongs to a logical channel with higher priority than the priority of any logical channel containing available UL data which belong to any LCG; or
 - none of the logical channels which belong to an LCG contains any available UL data.

in which case the BSR is referred below to as 'Regular BSR';

- UL resources are allocated and number of padding bits is equal to or larger than the size of the Buffer Status Report MAC CE plus its subheader, in which case the BSR is referred below to as 'Padding BSR';
- *retxBSR-Timer* expires, and at least one of the logical channels which belong to an LCG contains UL data, in which case the BSR is referred below to as 'Regular BSR';
- *periodicBSR-Timer* expires, in which case the BSR is referred below to as 'Periodic BSR'.

For Regular BSR, the MAC entity shall:

- 1> if the BSR is triggered for a logical channel for which *logicalChannelSR-DelayTimerApplied* is configured by upper layers:
 - 2> start or restart the *logicalChannelSR-DelayTimer*.
- 1> else:
 - 2> if running, stop the *logicalChannelSR-DelayTimer*.

For Regular and Periodic BSR, the MAC entity shall:

- 1> if more than one LCG has data available for transmission when the MAC PDU containing the BSR is to be built:
 - 2> report Long BSR for all LCGs which have data available for transmission.
- 1> else:
 - 2> report Short BSR.

For Padding BSR:

- 1> if the number of padding bits is equal to or larger than the size of the Short BSR plus its subheader but smaller than the size of the Long BSR plus its subheader:
 - 2> if more than one LCG has data available for transmission when the BSR is to be built:
 - 3> if the number of padding bits is equal to the size of the Short BSR plus its subheader:
 - 4> report Short Truncated BSR of the LCG with the highest priority logical channel with data available for transmission.
 - 3> else:
 - 4> report Long Truncated BSR of the LCG(s) with the logical channels having data available for transmission following a decreasing order of the highest priority logical channel (with or without data available for transmission) in each of these LCG(s), and in case of equal priority, in increasing order of LCGID.
 - 2> else:
 - 3> report Short BSR.
- 1> else if the number of padding bits is equal to or larger than the size of the Long BSR plus its subheader:
 - 2> report Long BSR for all LCGs which have data available for transmission.

For BSR triggered by *retxBSR-Timer* expiry, the MAC entity considers that the logical channel that triggered the BSR is the highest priority logical channel that has data available for transmission at the time the BSR is triggered.

The MAC entity shall:

- 1> if the Buffer Status reporting procedure determines that at least one BSR has been triggered and not cancelled:
 - 2> if UL-SCH resources are available for a new transmission and the UL-SCH resources can accommodate the BSR MAC CE plus its subheader as a result of logical channel prioritization:
 - 3> instruct the Multiplexing and Assembly procedure to generate the BSR MAC CE(s);

- 3> start or restart *periodicBSR-Timer* except when all the generated BSRs are long or short Truncated BSRs;
- 3> start or restart *retxBSR-Timer*.
- 2> if a Regular BSR has been triggered and *logicalChannelSR-DelayTimer* is not running:
 - 3> if there is no UL-SCH resource available for a new transmission; or
 - 3> if the MAC entity is configured with configured uplink grant(s) and the Regular BSR was not triggered for a logical channel for which logical channel SR masking (*logicalChannelSR-Mask*) is setup by upper layers; or
 - 3> if the UL-SCH resources available for a new transmission do not meet the LCP mapping restrictions (see subclause 5.4.3.1) configured for the logical channel(s) that triggered the BSR(s):
 - 4> trigger a Scheduling Request.

NOTE: UL-SCH resources are considered available if the MAC entity has an active configuration for either type of configured uplink grants, or if the MAC entity has received a dynamic uplink grant, or if both of these conditions are met. If the MAC entity has determined at a given point in time that UL-SCH resources are available, this need not imply that UL-SCH resources are available for use at that point in time.

A MAC PDU shall contain at most one BSR MAC CE, even when multiple events have triggered a BSR. The Regular BSR and the Periodic BSR shall have precedence over the padding BSR.

The MAC entity shall restart *retxBSR-Timer* upon reception of a grant for transmission of new data on any UL-SCH.

All triggered BSRs may be cancelled when the UL grant(s) can accommodate all pending data available for transmission but is not sufficient to additionally accommodate the BSR MAC CE plus its subheader. All BSRs triggered prior to MAC PDU assembly shall be cancelled when a MAC PDU is transmitted and this PDU includes a Long or Short BSR MAC CE which contains buffer status up to (and including) the last event that triggered a BSR prior to the MAC PDU assembly.

NOTE: MAC PDU assembly can happen at any point in time between uplink grant reception and actual transmission of the corresponding MAC PDU. BSR and SR can be triggered after the assembly of a MAC PDU which contains a BSR MAC CE, but before the transmission of this MAC PDU. In addition, BSR and SR can be triggered during MAC PDU assembly.

5.4.6 Power Headroom Reporting

The Power Headroom reporting procedure is used to provide the serving gNB with the following information:

- Type 1 power headroom: the difference between the nominal UE maximum transmit power and the estimated power for UL-SCH transmission per activated Serving Cell;
- Type 2 power headroom: the difference between the nominal UE maximum transmit power and the estimated power for UL-SCH and PUCCH transmission on SpCell of the other MAC entity (i.e. E-UTRA MAC entity in EN-DC case only);
- Type 3 power headroom: the difference between the nominal UE maximum transmit power and the estimated power for SRS transmission per activated Serving Cell.

RRC controls Power Headroom reporting by configuring the following parameters:

- *phr-PeriodicTimer*;
- *phr-ProhibitTimer*;
- *phr-Tx-PowerFactorChange*;
- *phr-Type2OtherCell*;
- *phr-ModeOtherCG*;
- *multiplePHR*.

A Power Headroom Report (PHR) shall be triggered if any of the following events occur:

- *phr-ProhibitTimer* expires or has expired and the path loss has changed more than *phr-Tx-PowerFactorChange* dB for at least one activated Serving Cell of any MAC entity which is used as a pathloss reference since the last transmission of a PHR in this MAC entity when the MAC entity has UL resources for new transmission;

NOTE 1: The path loss variation for one cell assessed above is between the pathloss measured at present time on the current pathloss reference and the pathloss measured at the transmission time of the last transmission of PHR on the pathloss reference in use at that time, irrespective of whether the pathloss reference has changed in between.

- *phr-PeriodicTimer* expires;
- upon configuration or reconfiguration of the power headroom reporting functionality by upper layers, which is not used to disable the function;
- activation of an SCell of any MAC entity with configured uplink;
- addition of the PSCell (i.e. PSCell is newly added or changed);
- *phr-ProhibitTimer* expires or has expired, when the MAC entity has UL resources for new transmission, and the following is true for any of the activated Serving Cells of any MAC entity with configured uplink:
 - there are UL resources allocated for transmission or there is a PUCCH transmission on this cell, and the required power backoff due to power management (as allowed by $P\text{-MPR}_c$ as specified in TS 38.101 [10]) for this cell has changed more than *phr-Tx-PowerFactorChange* dB since the last transmission of a PHR when the MAC entity had UL resources allocated for transmission or PUCCH transmission on this cell.

NOTE 2: The MAC entity should avoid triggering a PHR when the required power backoff due to power management decreases only temporarily (e.g. for up to a few tens of milliseconds) and it should avoid reflecting such temporary decrease in the values of $P_{\text{CMAX},f,c}/\text{PH}$ when a PHR is triggered by other triggering conditions.

If the MAC entity has UL resources allocated for a new transmission the MAC entity shall:

- 1> if it is the first UL resource allocated for a new transmission since the last MAC reset:
 - 2> start *phr-PeriodicTimer*;
- 1> if the Power Headroom reporting procedure determines that at least one PHR has been triggered and not cancelled; and
- 1> if the allocated UL resources can accommodate the MAC CE for PHR which the MAC entity is configured to transmit, plus its subheader, as a result of LCP as defined in subclause 5.4.3.1:
 - 2> if *multiplePHR* is configured:
 - 3> for each activated Serving Cell with configured uplink associated with any MAC entity:
 - 4> obtain the value of the Type 1 or Type 3 power headroom for the corresponding uplink carrier;
 - 4> if this MAC entity has UL resources allocated for transmission on this Serving Cell; or
 - 4> if the other MAC entity, if configured, has UL resources allocated for transmission on this Serving Cell and *phr-ModeOtherCG* is set to real by upper layers:
 - 5> obtain the value for the corresponding $P_{\text{CMAX},f,c}$ field from the physical layer.
 - 3> if *phr-Type2OtherCell* is configured:
 - 4> if the other MAC entity is E-UTRA MAC entity:
 - 5> obtain the value of the Type 2 power headroom for the SpCell of the other MAC entity (i.e. E-UTRA MAC entity);
 - 5> if *phr-ModeOtherCG* is set to real by upper layers:

- 6> obtain the value for the corresponding $P_{\text{CMAX},f,c}$ field for the SpCell of the other MAC entity (i.e. E-UTRA MAC entity) from the physical layer.
- 3> instruct the Multiplexing and Assembly procedure to generate and transmit the Multiple Entry PHR MAC CE as defined in subclause 6.1.3.9 based on the values reported by the physical layer.
- 2> else (i.e. Single Entry PHR format is used):
 - 3> obtain the value of the Type 1 power headroom from the physical layer for the corresponding uplink carrier of the PCell;
 - 3> obtain the value for the corresponding $P_{\text{CMAX},f,c}$ field from the physical layer;
 - 3> instruct the Multiplexing and Assembly procedure to generate and transmit the Single Entry PHR MAC CE as defined in subclause 6.1.3.8 based on the values reported by the physical layer.
- 2> start or restart *phr-PeriodicTimer*;
- 2> start or restart *phr-ProhibitTimer*;
- 2> cancel all triggered PHR(s).

5.5 PCH reception

When the MAC entity needs to receive PCH, the MAC entity shall:

- 1> if a PCH assignment has been received on the PDCCH for the P-RNTI:
 - 2> attempt to decode the TB on the PCH as indicated by the PDCCH information;
 - 2> if the TB on the PCH has been successfully decoded:
 - 3> deliver the decoded MAC PDU to upper layers.

5.6 BCH reception

When the MAC entity needs to receive BCH, the MAC entity shall:

- 1> receive and attempt to decode the BCH;
- 1> if a TB on the BCH has been successfully decoded:
 - 2> deliver the decoded MAC PDU to upper layers.

5.7 Discontinuous Reception (DRX)

The MAC entity may be configured by RRC with a DRX functionality that controls the UE's PDCCH monitoring activity for the MAC entity's C-RNTI, CS-RNTI, INT-RNTI, SFI-RNTI, SP-CSI-RNTI, TPC-PUCCH-RNTI, TPC-PUSCH-RNTI, and TPC-SRS-RNTI. When using DRX operation, the MAC entity shall also monitor PDCCH according to requirements found in other subclauses of this specification. When in RRC_CONNECTED, if DRX is configured, the MAC entity may monitor the PDCCH discontinuously using the DRX operation specified in this subclause; otherwise the MAC entity shall monitor the PDCCH continuously.

RRC controls DRX operation by configuring the following parameters:

- *drx-onDurationTimer*: the duration at the beginning of a DRX Cycle;
- *drx-SlotOffset*: the delay before starting the *drx-onDurationTimer*;
- *drx-InactivityTimer*: the duration after the PDCCH occasion in which a PDCCH indicates a new UL or DL transmission for the MAC entity;

- *drx-RetransmissionTimerDL* (per DL HARQ process): the maximum duration until a DL retransmission is received;
- *drx-RetransmissionTimerUL* (per UL HARQ process): the maximum duration until a grant for UL retransmission is received;
- *drx-LongCycleStartOffset*: the Long DRX cycle and *drx-StartOffset* which defines the subframe where the Long and Short DRX Cycle starts;
- *drx-ShortCycle* (optional): the Short DRX cycle;
- *drx-ShortCycleTimer* (optional): the duration the UE shall follow the Short DRX cycle;
- *drx-HARQ-RTT-TimerDL* (per DL HARQ process): the minimum duration before a DL assignment for HARQ retransmission is expected by the MAC entity;
- *drx-HARQ-RTT-TimerUL* (per UL HARQ process): the minimum duration before a UL HARQ retransmission grant is expected by the MAC entity.

When a DRX cycle is configured, the Active Time includes the time while:

- *drx-onDurationTimer* or *drx-InactivityTimer* or *drx-RetransmissionTimerDL* or *drx-RetransmissionTimerUL* or *ra-ContentionResolutionTimer* (as described in subclause 5.1.5) is running; or
- a Scheduling Request is sent on PUCCH and is pending (as described in subclause 5.4.4); or
- a PDCCH indicating a new transmission addressed to the C-RNTI of the MAC entity has not been received after successful reception of a Random Access Response for the Random Access Preamble not selected by the MAC entity among the contention-based Random Access Preamble (as described in subclause 5.1.4).

When DRX is configured, the MAC entity shall:

- 1> if a MAC PDU is received in a configured downlink assignment:
 - 2> start the *drx-HARQ-RTT-TimerDL* for the corresponding HARQ process in the first symbol after the end of the corresponding transmission carrying the DL HARQ feedback;
 - 2> stop the *drx-RetransmissionTimerDL* for the corresponding HARQ process.
- 1> if a MAC PDU is transmitted in a configured uplink grant:
 - 2> start the *drx-HARQ-RTT-TimerUL* for the corresponding HARQ process in the first symbol after the end of the first repetition of the corresponding PUSCH transmission;
 - 2> stop the *drx-RetransmissionTimerUL* for the corresponding HARQ process.
- 1> if a *drx-HARQ-RTT-TimerDL* expires:
 - 2> if the data of the corresponding HARQ process was not successfully decoded:
 - 3> start the *drx-RetransmissionTimerDL* for the corresponding HARQ process in the first symbol after the expiry of *drx-HARQ-RTT-TimerDL*.
- 1> if a *drx-HARQ-RTT-TimerUL* expires:
 - 2> start the *drx-RetransmissionTimerUL* for the corresponding HARQ process in the first symbol after the expiry of *drx-HARQ-RTT-TimerUL*.
- 1> if a DRX Command MAC CE or a Long DRX Command MAC CE is received:
 - 2> stop *drx-onDurationTimer*;
 - 2> stop *drx-InactivityTimer*.
- 1> if *drx-InactivityTimer* expires or a DRX Command MAC CE is received:
 - 2> if the Short DRX cycle is configured:

- 3> start or restart *drx-ShortCycleTimer* in the first symbol after the expiry of *drx-InactivityTimer* or in the first symbol after the end of DRX Command MAC CE reception;
- 3> use the Short DRX Cycle.
- 2> else:
 - 3> use the Long DRX cycle.
- 1> if *drx-ShortCycleTimer* expires:
 - 2> use the Long DRX cycle.
- 1> if a Long DRX Command MAC CE is received:
 - 2> stop *drx-ShortCycleTimer*;
 - 2> use the Long DRX cycle.
- 1> if the Short DRX Cycle is used, and $[(SFN \times 10) + \text{subframe number}] \bmod (drx-ShortCycle) = (drx-StartOffset) \bmod (drx-ShortCycle)$; or
- 1> if the Long DRX Cycle is used, and $[(SFN \times 10) + \text{subframe number}] \bmod (drx-LongCycle) = drx-StartOffset$:
 - 2> start *drx-onDurationTimer* after *drx-SlotOffset* from the beginning of the subframe.
- 1> if the MAC entity is in Active Time:
 - 2> monitor the PDCCH;
 - 2> if the PDCCH indicates a DL transmission:
 - 3> start the *drx-HARQ-RTT-TimerDL* for the corresponding HARQ process in the first symbol after the end of the corresponding transmission carrying the DL HARQ feedback;
 - 3> stop the *drx-RetransmissionTimerDL* for the corresponding HARQ process.
 - 2> if the PDCCH indicates a UL transmission:
 - 3> start the *drx-HARQ-RTT-TimerUL* for the corresponding HARQ process in the first symbol after the end of the first repetition of the corresponding PUSCH transmission;
 - 3> stop the *drx-RetransmissionTimerUL* for the corresponding HARQ process.
 - 2> if the PDCCH indicates a new transmission (DL or UL):
 - 3> start or restart *drx-InactivityTimer* in the first symbol after the end of the PDCCH reception.
- 1> in current symbol *n*, if the MAC entity would not be in Active Time considering grants/assignments/DRX Command MAC CE/Long DRX Command MAC CE received and Scheduling Request sent 4 ms prior to symbol *n* when evaluating all DRX Active Time conditions as specified in this subclause:
 - 2> not transmit periodic SRS and semi-persistent SRS defined in TS 38.214 [7].
- 1> if CSI masking (*csi-Mask*) is setup by upper layers:
 - 2> in current symbol *n*, if *onDurationTimer* would not be running considering grants/assignments/DRX Command MAC CE/Long DRX Command MAC CE received 4 ms prior to symbol *n* when evaluating all DRX Active Time conditions as specified in this subclause:
 - 3> not report CSI on PUCCH.
- 1> else:
 - 2> in current symbol *n*, if the MAC entity would not be in Active Time considering grants/assignments/DRX Command MAC CE/Long DRX Command MAC CE received and Scheduling Request sent 4 ms prior to symbol *n* when evaluating all DRX Active Time conditions as specified in this subclause:

3> not report CSI on PUCCH and semi-persistent CSI on PUSCH.

Regardless of whether the MAC entity is monitoring PDCCH or not, the MAC entity transmits HARQ feedback and aperiodic SRS defined in TS 38.214 [7] when such is expected.

The MAC entity needs not to monitor the PDCCH if it is not a complete PDCCH occasion (e.g. the Active Time starts or ends in the middle of a PDCCH occasion).

5.8 Transmission and reception without dynamic scheduling

5.8.1 Downlink

Semi-Persistent Scheduling (SPS) is configured by RRC per Serving Cell and per BWP. Multiple configurations can be active simultaneously only on different Serving Cells. Activation and deactivation of the DL SPS are independent among the Serving Cells.

For the DL SPS, a DL assignment is provided by PDCCH, and stored or cleared based on L1 signalling indicating SPS activation or deactivation.

RRC configures the following parameters when SPS is configured:

- *cs-RNTI*: CS-RNTI for activation, deactivation, and retransmission;
- *nrofHARQ-Processes*: the number of configured HARQ processes for SPS;
- *periodicity*: periodicity of configured downlink assignment for SPS.

When SPS is released by upper layers, all the corresponding configurations shall be released.

After a downlink assignment is configured for SPS, the MAC entity shall consider sequentially that the Nth downlink assignment occurs in the slot for which:

$$\frac{(numberOfSlotsPerFrame \times SFN + \text{slot number in the frame}) - [(numberOfSlotsPerFrame \times SFN_{start\ time} + \text{slot}_{start\ time}) + N \times periodicity \times numberOfSlotsPerFrame / 10] \text{ modulo } (1024 \times numberOfSlotsPerFrame)}{numberOfSlotsPerFrame}$$

where $SFN_{start\ time}$ and $\text{slot}_{start\ time}$ are the SFN and slot, respectively, of the first transmission of PDSCH where the configured downlink assignment was (re-)initialised.

5.8.2 Uplink

There are two types of transmission without dynamic grant:

- configured grant Type 1 where an uplink grant is provided by RRC, and stored as configured uplink grant;
- configured grant Type 2 where an uplink grant is provided by PDCCH, and stored or cleared as configured uplink grant based on L1 signalling indicating configured uplink grant activation or deactivation.

Type 1 and Type 2 are configured by RRC per Serving Cell and per BWP. Multiple configurations can be active simultaneously only on different Serving Cells. For Type 2, activation and deactivation are independent among the Serving Cells. For the same Serving Cell, the MAC entity is configured with either Type 1 or Type 2.

RRC configures the following parameters when the configured grant Type 1 is configured:

- *cs-RNTI*: CS-RNTI for retransmission;
- *periodicity*: periodicity of the configured grant Type 1;
- *timeDomainOffset*: Offset of a resource with respect to SFN=0 in time domain;
- *timeDomainAllocation*: Allocation of configured uplink grant in time domain which contains *startSymbolAndLength* (i.e. *SLIV* in TS 38.214 [7]);
- *nrofHARQ-Processes*: the number of HARQ processes for configured grant.

RRC configures the following parameters when the configured grant Type 2 is configured:

- *cs-RNTI*: CS-RNTI for activation, deactivation, and retransmission;
- *periodicity*: periodicity of the configured grant Type 2;
- *nrofHARQ-Processes*: the number of HARQ processes for configured grant.

Upon configuration of a configured grant Type 1 for a Serving Cell by upper layers, the MAC entity shall:

- 1> store the uplink grant provided by upper layers as a configured uplink grant for the indicated Serving Cell;
- 1> initialise or re-initialise the configured uplink grant to start in the symbol according to *timeDomainOffset* and *S* (derived from *SLIV* as specified in TS 38.214 [7]), and to reoccur with *periodicity*.

After an uplink grant is configured for a configured grant Type 1, the MAC entity shall consider that the uplink grant recurs associated with each symbol for which:

$$[(SFN \times \text{numberOfSlotsPerFrame} \times \text{numberOfSymbolsPerSlot}) + (\text{slot number in the frame} \times \text{numberOfSymbolsPerSlot}) + \text{symbol number in the slot}] = (\text{timeDomainOffset} \times \text{numberOfSymbolsPerSlot} + S + N \times \text{periodicity}) \text{ modulo } (1024 \times \text{numberOfSlotsPerFrame} \times \text{numberOfSymbolsPerSlot}), \text{ for all } N \geq 0.$$

After an uplink grant is configured for a configured grant Type 2, the MAC entity shall consider that the uplink grant recurs associated with each symbol for which:

$$[(SFN \times \text{numberOfSlotsPerFrame} \times \text{numberOfSymbolsPerSlot}) + (\text{slot number in the frame} \times \text{numberOfSymbolsPerSlot}) + \text{symbol number in the slot}] = [(SFN_{\text{start time}} \times \text{numberOfSlotsPerFrame} \times \text{numberOfSymbolsPerSlot} + \text{slot}_{\text{start time}} \times \text{numberOfSymbolsPerSlot} + \text{symbol}_{\text{start time}}) + N \times \text{periodicity}] \text{ modulo } (1024 \times \text{numberOfSlotsPerFrame} \times \text{numberOfSymbolsPerSlot}), \text{ for all } N \geq 0.$$

where $SFN_{\text{start time}}$, $\text{slot}_{\text{start time}}$, and $\text{symbol}_{\text{start time}}$ are the SFN, slot, and symbol, respectively, of the first transmission opportunity of PUSCH where the configured uplink grant was (re-)initialised.

When a configured uplink grant is released by upper layers, all the corresponding configurations shall be released and all corresponding uplink grants shall be cleared.

The MAC entity shall:

- 1> if the configured uplink grant confirmation has been triggered and not cancelled; and
- 1> if the MAC entity has UL resources allocated for new transmission:
 - 2> instruct the Multiplexing and Assembly procedure to generate an Configured Grant Confirmation MAC CE as defined in subclause 6.1.3.7;
 - 2> cancel the triggered configured uplink grant confirmation.

For a configured grant Type 2, the MAC entity shall clear the configured uplink grant immediately after first transmission of Configured Grant Confirmation MAC CE triggered by the configured uplink grant deactivation.

Retransmissions except for repetition of configured uplink grants use uplink grants addressed to CS-RNTI.

5.9 Activation/Deactivation of SCells

If the MAC entity is configured with one or more SCells, the network may activate and deactivate the configured SCells. Upon configuration of an SCell, the SCell is deactivated.

The configured SCell(s) is activated and deactivated by:

- receiving the SCell Activation/Deactivation MAC CE described in subclause 6.1.3.10;
- configuring *sCellDeactivationTimer* timer per configured SCell (except the SCell configured with PUCCH, if any): the associated SCell is deactivated upon its expiry.

The MAC entity shall for each configured SCell:

- 1> if an SCell Activation/Deactivation MAC CE is received activating the SCell:
 - 2> activate the SCell according to the timing defined in TS 38.213 [6]; i.e. apply normal SCell operation including:
 - 3> SRS transmissions on the SCell;
 - 3> CSI reporting for the SCell;
 - 3> PDCCH monitoring on the SCell;
 - 3> PDCCH monitoring for the SCell;
 - 3> PUCCH transmissions on the SCell, if configured.
 - 2> if the SCell was deactivated prior to receiving this SCell Activation/Deactivation MAC CE:
 - 3> activate the DL BWP and UL BWP indicated by *firstActiveDownlinkBWP-Id* and *firstActiveUplinkBWP-Id* respectively;
 - 2> start or restart the *sCellDeactivationTimer* associated with the SCell according to the timing defined in TS 38.213 [6];
 - 2> (re-)initialize any suspended configured uplink grants of configured grant Type 1 associated with this SCell according to the stored configuration, if any, and to start in the symbol according to rules in subclause 5.8.2;
 - 2> trigger PHR according to subclause 5.4.6.
- 1> else if an SCell Activation/Deactivation MAC CE is received deactivating the SCell; or
- 1> if the *sCellDeactivationTimer* associated with the activated SCell expires:
 - 2> deactivate the SCell according to the timing defined in TS 38.213 [6];
 - 2> stop the *sCellDeactivationTimer* associated with the SCell;
 - 2> stop the *bwp-InactivityTimer* associated with the SCell;
 - 2> deactivate any active BWP associated with the SCell;
 - 2> clear any configured downlink assignment and any configured uplink grant Type 2 associated with the SCell respectively;
 - 2> clear any PUSCH resource for semi-persistent CSI reporting associated with the SCell;
 - 2> suspend any configured uplink grant Type 1 associated with the SCell;
 - 2> flush all HARQ buffers associated with the SCell.
- 1> if PDCCH on the activated SCell indicates an uplink grant or downlink assignment; or
- 1> if PDCCH on the Serving Cell scheduling the activated SCell indicates an uplink grant or a downlink assignment for the activated SCell; or
- 1> if a MAC PDU is transmitted in a configured uplink grant or received in a configured downlink assignment:
 - 2> restart the *sCellDeactivationTimer* associated with the SCell.
- 1> if the SCell is deactivated:
 - 2> not transmit SRS on the SCell;
 - 2> not report CSI for the SCell;
 - 2> not transmit on UL-SCH on the SCell;
 - 2> not transmit on RACH on the SCell;

- 2> not monitor the PDCCH on the SCell;
- 2> not monitor the PDCCH for the SCell;
- 2> not transmit PUCCH on the SCell.

HARQ feedback for the MAC PDU containing SCell Activation/Deactivation MAC CE shall not be impacted by PCell, PSCell and PUCCH SCell interruptions due to SCell activation/deactivation in TS 38.133 [11].

When SCell is deactivated, the ongoing Random Access procedure on the SCell, if any, is aborted.

5.10 Activation/Deactivation of PDCP duplication

If one or more DRBs are configured with PDCP duplication, the network may activate and deactivate the PDCP duplication for the configured DRB(s).

The PDCP duplication for the configured DRB(s) is activated and deactivated by:

- receiving the Duplication Activation/Deactivation MAC CE described in subclause 6.1.3.11;
- indication by RRC.

The MAC entity shall for each DRB configured with PDCP duplication:

- 1> if a Duplication Activation/Deactivation MAC CE is received activating the PDCP duplication of the DRB:
 - 2> indicate the activation of PDCP duplication of the DRB to upper layers.
- 1> if a Duplication Activation/Deactivation MAC CE is received deactivating the PDCP duplication of the DRB:
 - 2> indicate the deactivation of PDCP duplication of the DRB to upper layers.

5.11 MAC reconfiguration

When a reconfiguration of the MAC entity is requested by upper layers, the MAC entity shall:

- 1> initialize the corresponding HARQ entity upon addition of an SCell;
- 1> remove the corresponding HARQ entity upon removal of an SCell;
- 1> apply the new value for timers when the timer is (re)started;
- 1> apply the new maximum parameter value when counters are initialized;
- 1> apply immediately the configurations received from upper layers for other parameters.

5.12 MAC Reset

If a reset of the MAC entity is requested by upper layers, the MAC entity shall:

- 1> initialize B_j for each logical channel to zero;
- 1> stop (if running) all timers;
- 1> consider all *timeAlignmentTimers* as expired and perform the corresponding actions in subclause 5.2;
- 1> set the NDIs for all uplink HARQ processes to the value 0;
- 1> stop, if any, ongoing RACH procedure;
- 1> discard explicitly signalled contention-free Random Access Resources, if any;
- 1> flush Msg3 buffer;

- 1> cancel, if any, triggered Scheduling Request procedure;
- 1> cancel, if any, triggered Buffer Status Reporting procedure;
- 1> cancel, if any, triggered Power Headroom Reporting procedure;
- 1> flush the soft buffers for all DL HARQ processes;
- 1> for each DL HARQ process, consider the next received transmission for a TB as the very first transmission;
- 1> release, if any, Temporary C-RNTI;
- 1> reset *BFI_COUNTER*.

5.13 Handling of unknown, unforeseen and erroneous protocol data

When a MAC entity receives a MAC PDU for the MAC entity's C-RNTI or CS-RNTI, or by the configured downlink assignment, containing a Reserved LCID value, or an LCID value the MAC Entity does not support, the MAC entity shall at least:

- 1> discard the received subPDU and any remaining subPDUs in the MAC PDU.

When a MAC entity receives a MAC PDU for the MAC entity's C-RNTI or CS-RNTI, or by the configured downlink assignment, containing an LCID value which is not configured, the MAC entity shall at least:

- 1> discard the received subPDU.

5.14 Handling of measurement gaps

During a measurement gap, the MAC entity shall, on the Serving Cell(s) in the corresponding frequency range of the measurement gap configured by *measGapConfig* as specified in TS 38.331 [5]:

- 1> not perform the transmission of HARQ feedback, SR, and CSI;
- 1> not report SRS;
- 1> not transmit on UL-SCH except for Msg3 as specified in subclause 5.4.2.2;
- 1> if the *ra-ResponseWindow* or the *ra-ContentionResolutionTimer* is running:
 - 2> monitor the PDCCH as specified in subclauses 5.1.4 and 5.1.5.
- 1> else:
 - 2> not monitor the PDCCH.

5.15 Bandwidth Part (BWP) operation

In addition to clause 12 of TS 38.213 [6], this subclause specifies requirements on BWP operation.

A Serving Cell may be configured with one or multiple BWPs, and the maximum number of BWP per Serving Cell is specified in TS 38.213 [6].

The BWP switching for a Serving Cell is used to activate an inactive BWP and deactivate an active BWP at a time. The BWP switching is controlled by the PDCCH indicating a downlink assignment or an uplink grant, by the *bwp-InactivityTimer*, by RRC signalling, or by the MAC entity itself upon initiation of Random Access procedure. Upon RRC (re-)configuration of *firstActiveDownlinkBWP-Id* and/or *firstActiveUplinkBWP-Id* for SpCell or activation of an SCell, the DL BWP and/or UL BWP indicated by *firstActiveDownlinkBWP-Id* and/or *firstActiveUplinkBWP-Id* respectively (as specified in TS 38.331 [5]) is active without receiving PDCCH indicating a downlink assignment or an uplink grant. The active BWP for a Serving Cell is indicated by either RRC or PDCCH (as specified in TS 38.213 [6]). For unpaired spectrum, a DL BWP is paired with a UL BWP, and BWP switching is common for both UL and DL.

For each activated Serving Cell configured with a BWP, the MAC entity shall:

- 1> if a BWP is activated:
 - 2> transmit on UL-SCH on the BWP;
 - 2> transmit on RACH on the BWP, if PRACH occasions are configured;
 - 2> monitor the PDCCH on the BWP;
 - 2> transmit PUCCH on the BWP, if configured;
 - 2> report CSI for the BWP;
 - 2> transmit SRS on the BWP, if configured;
 - 2> receive DL-SCH on the BWP;
 - 2> (re-)initialize any suspended configured uplink grants of configured grant Type 1 on the active BWP according to the stored configuration, if any, and to start in the symbol according to rules in subclause 5.8.2.
- 1> if a BWP is deactivated:
 - 2> not transmit on UL-SCH on the BWP;
 - 2> not transmit on RACH on the BWP;
 - 2> not monitor the PDCCH on the BWP;
 - 2> not transmit PUCCH on the BWP;
 - 2> not report CSI for the BWP;
 - 2> not transmit SRS on the BWP;
 - 2> not receive DL-SCH on the BWP;
 - 2> clear any configured downlink assignment and configured uplink grant of configured grant Type 2 on the BWP;
 - 2> suspend any configured uplink grant of configured grant Type 1 on the inactive BWP.

Upon initiation of the Random Access procedure on a Serving Cell, the MAC entity shall for this Serving Cell:

- 1> if PRACH occasions are not configured for the active UL BWP:
 - 2> switch the active UL BWP to BWP indicated by *initialUplinkBWP*;
 - 2> if the Serving Cell is a SpCell:
 - 3> switch the active DL BWP to BWP indicated by *initialDownlinkBWP*.
- 1> else:
 - 2> if the Serving Cell is a SpCell:
 - 3> if the active DL BWP does not have the same *bwp-Id* as the active UL BWP:
 - 4> switch the active DL BWP to the DL BWP with the same *bwp-Id* as the active UL BWP.
- 1> stop the *bwp-InactivityTimer* associated with the active DL BWP of this Serving Cell, if running.
- 1> if the Serving Cell is SCell:
 - 2> stop the *bwp-InactivityTimer* associated with the active DL BWP of SpCell, if running.
- 1> perform the Random Access procedure on the active DL BWP of SpCell and active UL BWP of this Serving Cell.

If the MAC entity receives a PDCCH for BWP switching of a Serving Cell, the MAC entity shall:

- 1> if there is no ongoing Random Access procedure associated with this Serving Cell; or
- 1> if the ongoing Random Access procedure associated with this Serving Cell is successfully completed upon reception of this PDCCH addressed to C-RNTI (as specified in subclauses 5.1.4 and 5.1.5):
 - 2> perform BWP switching to a BWP indicated by the PDCCH.

If the MAC entity receives a PDCCH for BWP switching for a Serving Cell while a Random Access procedure associated with that Serving Cell is ongoing in the MAC entity, it is up to UE implementation whether to switch BWP or ignore the PDCCH for BWP switching, except for the PDCCH reception for BWP switching addressed to the C-RNTI for successful Random Access procedure completion (as specified in subclauses 5.1.4 and 5.1.5) in which case the UE shall perform BWP switching to a BWP indicated by the PDCCH. Upon reception of the PDCCH for BWP switching other than successful contention resolution, if the MAC entity decides to perform BWP switching, the MAC entity shall stop the ongoing Random Access procedure and initiate a Random Access procedure after performing the BWP switching; if the MAC decides to ignore the PDCCH for BWP switching, the MAC entity shall continue with the ongoing Random Access procedure on the Serving Cell.

The MAC entity shall for each activated Serving Cell configured with *bwp-InactivityTimer*:

- 1> if the *defaultDownlinkBWP-Id* is configured, and the active DL BWP is not the BWP indicated by the *defaultDownlinkBWP-Id*; or
- 1> if the *defaultDownlinkBWP-Id* is not configured, and the active DL BWP is not the *initialDownlinkBWP*:
 - 2> if a PDCCH addressed to C-RNTI or CS-RNTI indicating downlink assignment or uplink grant is received on the active BWP; or
 - 2> if a PDCCH addressed to C-RNTI or CS-RNTI indicating downlink assignment or uplink grant is received for the active BWP; or
 - 2> if a MAC PDU is transmitted in a configured uplink grant or received in a configured downlink assignment:
 - 3> if there is no ongoing random access procedure associated with this Serving Cell; or
 - 3> if the ongoing Random Access procedure associated with this Serving Cell is successfully completed upon reception of this PDCCH addressed to C-RNTI (as specified in subclauses 5.1.4 and 5.1.5):
 - 4> start or restart the *bwp-InactivityTimer* associated with the active DL BWP.
 - 2> if the *bwp-InactivityTimer* associated with the active DL BWP expires:
 - 3> if the *defaultDownlinkBWP-Id* is configured:
 - 4> perform BWP switching to a BWP indicated by the *defaultDownlinkBWP-Id*.
 - 3> else:
 - 4> perform BWP switching to the *initialDownlinkBWP*.

NOTE: If a Random Access procedure is initiated on an SCell, both this SCell and the SpCell are associated with this Random Access procedure.

- 1> if a PDCCH for BWP switching is received, and the MAC entity switches the active BWP:
 - 2> if the *defaultDownlinkBWP-Id* is configured, and the MAC entity switches to the BWP which is not indicated by the *defaultDownlinkBWP-Id*; or
 - 2> if the *defaultDownlinkBWP-Id* is not configured, and the MAC entity switches to the BWP which is not the *initialDownlinkBWP*:
 - 3> start or restart the *bwp-InactivityTimer* associated with the active DL BWP.

5.16 SUL operation

The Supplementary UL (SUL) carrier can be configured as a complement to the normal UL (NUL) carrier. Switching between the NUL carrier and the SUL carrier means that the UL transmissions move from the PUSCH on one carrier to the other carrier. This is done via an indication in DCI. If the MAC entity receives a UL grant indicating a SUL switch while a Random Access procedure is ongoing, the MAC entity shall ignore the UL grant.

The Serving Cell configured with *supplementaryUplink* belongs to a single TAG.

5.17 Beam Failure Detection and Recovery procedure

The MAC entity may be configured by RRC with a beam failure recovery procedure which is used for indicating to the serving gNB of a new SSB or CSI-RS when beam failure is detected on the serving SSB(s)/CSI-RS(s). Beam failure is detected by counting beam failure instance indication from the lower layers to the MAC entity.

RRC configures the following parameters in the *BeamFailureRecoveryConfig* and the *RadioLinkMonitoringConfig* for the Beam Failure Detection and Recovery procedure:

- *beamFailureInstanceMaxCount* for the beam failure detection;
- *beamFailureDetectionTimer* for the beam failure detection;
- *beamFailureRecoveryTimer* for the beam failure recovery procedure;
- *rsrp-ThresholdSSB*: an RSRP threshold for the beam failure recovery;
- *powerRampingStep*: *powerRampingStep* for the beam failure recovery;
- *powerRampingStepHighPriority*: *powerRampingStepHighPriority* for the beam failure recovery;
- *preambleReceivedTargetPower*: *preambleReceivedTargetPower* for the beam failure recovery;
- *preambleTransMax*: *preambleTransMax* for the beam failure recovery;
- *scalingFactorBI*: *scalingFactorBI* for the beam failure recovery;
- *ssb-perRACH-Occasion*: *ssb-perRACH-Occasion* for the beam failure recovery;
- *ra-ResponseWindow*: the time window to monitor response(s) for the beam failure recovery using contention-free Random Access Preamble;
- *prach-ConfigurationIndex*: *prach-ConfigurationIndex* for the beam failure recovery;
- *ra-ssb-OccasionMaskIndex*: *ra-ssb-OccasionMaskIndex* for the beam failure recovery;
- *ra-OccasionList*: *ra-OccasionList* for the beam failure recovery.

The following UE variables are used for the beam failure detection procedure:

- *BFI_COUNTER*: counter for beam failure instance indication which is initially set to 0.

The MAC entity shall:

- 1> if beam failure instance indication has been received from lower layers:
 - 2> start or restart the *beamFailureDetectionTimer*;
 - 2> increment *BFI_COUNTER* by 1;
 - 2> if *BFI_COUNTER* \geq *beamFailureInstanceMaxCount*:
 - 3> if *beamFailureRecoveryConfig* is configured for the active UL BWP:
 - 4> start the *beamFailureRecoveryTimer*, if configured;

- 4> initiate a Random Access procedure (see subclause 5.1) on the SpCell by applying the parameters *powerRampingStep*, *preambleReceivedTargetPower*, and *preambleTransMax* configured in *beamFailureRecoveryConfig*.
- 3> else:
 - 4> initiate a Random Access procedure (see subclause 5.1) on the SpCell.
- 1> if the *beamFailureDetectionTimer* expires; or
- 1> if *beamFailureDetectionTimer*, *beamFailureInstanceMaxCount*, or any of the reference signals used for beam failure detection is reconfigured by upper layers:
 - 2> set *BFI_COUNTER* to 0.
- 1> if the Random Access procedure is successfully completed (see subclause 5.1):
 - 2> set *BFI_COUNTER* to 0;
 - 2> stop the *beamFailureRecoveryTimer*, if configured;
 - 2> consider the Beam Failure Recovery procedure successfully completed.

5.18 Handling of MAC CEs

5.18.1 General

This subclause specifies the requirements upon reception of the following MAC CEs:

- SP CSI-RS / CSI-IM Resource Set Activation/Deactivation MAC CE;
- Aperiodic CSI Trigger State Subselection MAC CE;
- TCI States Activation/Deactivation for UE-specific PDSCH MAC CE;
- TCI State Indication for UE-specific PDCCH MAC CE;
- SP CSI reporting on PUCCH Activation/Deactivation MAC CE;
- SP SRS Activation/Deactivation MAC CE;
- PUCCH spatial relation Activation/Deactivation MAC CE;
- SP ZP CSI-RS Resource Set Activation/Deactivation MAC CE;
- Recommended Bit Rate MAC CE.

5.18.2 Activation/Deactivation of Semi-persistent CSI-RS/CSI-IM resource set

The network may activate and deactivate the configured Semi-persistent CSI-RS/CSI-IM resource sets of a Serving Cell by sending the SP CSI-RS / CSI-IM Resource Set Activation/Deactivation MAC CE described in subclause 6.1.3.12. The configured Semi-persistent CSI-RS/CSI-IM resource sets are initially deactivated upon configuration and after a handover.

The MAC entity shall:

- 1> if the MAC entity receives an SP CSI-RS / CSI-IM Resource Set Activation/Deactivation MAC CE on a Serving Cell:
 - 2> indicate to lower layers the information regarding the SP CSI-RS / CSI-IM Resource Set Activation/Deactivation MAC CE.

5.18.3 Aperiodic CSI Trigger State subselection

The network may select among the configured aperiodic CSI trigger states of a Serving Cell by sending the Aperiodic CSI Trigger State Subselection MAC CE described in subclause 6.1.3.13.

The MAC entity shall:

- 1> if the MAC entity receives an Aperiodic CSI trigger State Subselection MAC CE on a Serving Cell:
- 2> indicate to lower layers the information regarding Aperiodic CSI trigger State Subselection MAC CE.

5.18.4 Activation/Deactivation of UE-specific PDSCH TCI state

The network may activate and deactivate the configured TCI states for PDSCH of a Serving Cell by sending the TCI States Activation/Deactivation for UE-specific PDSCH MAC CE described in subclause 6.1.3.14. The configured TCI states for PDSCH are initially deactivated upon configuration and after a handover.

The MAC entity shall:

- 1> if the MAC entity receives an TCI States Activation/Deactivation for UE-specific PDSCH MAC CE on a Serving Cell:
- 2> indicate to lower layers the information regarding the TCI States Activation/Deactivation for UE-specific PDSCH MAC CE.

5.18.5 Indication of TCI state for UE-specific PDCCH

The network may indicate a TCI state for PDCCH reception for a CORESET of a Serving Cell by sending the TCI State Indication for UE-specific PDCCH MAC CE described in subclause 6.1.3.15.

The MAC entity shall:

- 1> if the MAC entity receives a TCI State Indication for UE-specific PDCCH MAC CE on a Serving Cell:
- 2> indicate to lower layers the information regarding the TCI State Indication for UE-specific PDCCH MAC CE.

5.18.6 Activation/Deactivation of Semi-persistent CSI reporting on PUCCH

The network may activate and deactivate the configured Semi-persistent CSI reporting on PUCCH of a Serving Cell by sending the SP CSI reporting on PUCCH Activation/Deactivation MAC CE described in subclause 6.1.3.16. The configured Semi-persistent CSI reporting on PUCCH is initially deactivated upon configuration and after a handover.

The MAC entity shall:

- 1> if the MAC entity receives an SP CSI reporting on PUCCH Activation/Deactivation MAC CE on a Serving Cell:
- 2> indicate to lower layers the information regarding the SP CSI reporting on PUCCH Activation/Deactivation MAC CE.

5.18.7 Activation/Deactivation of Semi-persistent SRS

The network may activate and deactivate the configured Semi-persistent SRS resource sets of a Serving Cell by sending the SP SRS Activation/Deactivation MAC CE described in subclause 6.1.3.17. The configured Semi-persistent SRS resource sets are initially deactivated upon configuration and after a handover.

The MAC entity shall:

- 1> if the MAC entity receives an SP SRS Activation/Deactivation MAC CE on a Serving Cell:
- 2> indicate to lower layers the information regarding the SP SRS Activation/Deactivation MAC CE.

5.18.8 Activation/Deactivation of spatial relation of PUCCH resource

The network may activate and deactivate a spatial relation for a PUCCH resource of a Serving Cell by sending the PUCCH spatial relation Activation/Deactivation MAC CE described in subclause 6.1.3.18.

The MAC entity shall:

- 1> if the MAC entity receives a PUCCH spatial relation Activation/Deactivation MAC CE on a Serving Cell:
 - 2> indicate to lower layers the information regarding the PUCCH spatial relation Activation/Deactivation MAC CE.

5.18.9 Activation/Deactivation of semi-persistent ZP CSI-RS resource set

The network may activate and deactivate the configured Semi-persistent ZP CSI-RS resource set of a Serving Cell by sending the SP ZP CSI-RS Resource Set Activation/Deactivation MAC CE described in subclause 6.1.3.19. The configured Semi-persistent ZP CSI-RS resource sets are initially deactivated upon configuration and after a handover.

The MAC entity shall:

- 1> if the MAC entity receives an SP ZP CSI-RS Resource Set Activation/Deactivation MAC CE on a Serving Cell:
 - 2> indicate to lower layers the information regarding the SP ZP CSI-RS Resource Set Activation/Deactivation MAC CE.

5.18.10 Recommended Bit Rate

The recommended bit rate procedure is used to provide the MAC entity with information about the bit rate which the gNB recommends. The bit rate is the recommended bit rate of the physical layer. Averaging window of default value 2000 ms will apply as specified in TS 26.114 [13].

The gNB may transmit the Recommended bit rate MAC CE to the MAC entity to indicate the recommended bit rate for the UE for a specific logical channel and a specific direction (either uplink or downlink). Upon reception of a Recommended bit rate MAC CE the MAC entity shall:

- indicate to upper layers the recommended bit rate for the indicated logical channel and direction.

The MAC entity may request the gNB to indicate the recommended bit rate for a specific logical channel and a specific direction. If the MAC entity is requested by upper layers to query the gNB for the recommended bit rate for a logical channel and for a direction (i.e. for uplink or downlink), the MAC entity shall:

- 1> if a Recommended bit rate query for this logical channel and this direction has not been triggered:
 - 2> trigger a Recommended bit rate query for this logical channel, direction, and desired bit rate.

If the MAC entity has UL resources allocated for new transmission the MAC entity shall:

- 1> for each Recommended bit rate query that the Recommended Bit Rate procedure determines has been triggered and not cancelled:
 - 2> if *bitRateQueryProhibitTimer* for the logical channel and the direction of this Recommended bit rate query is configured, and it is not running; and
 - 2> if the MAC entity has UL resources allocated for new transmission and the allocated UL resources can accommodate a Recommended bit rate MAC CE plus its subheader as a result of LCP as defined in subclause 5.4.3.1:
 - 3> instruct the Multiplexing and Assembly procedure to generate the Recommended bit rate MAC CE for the logical channel and the direction of this Recommended bit rate query;
 - 3> start the *bitRateQueryProhibitTimer* for the logical channel and the direction of this Recommended bit rate query;
 - 3> cancel this Recommended bit rate query.

6 Protocol Data Units, formats and parameters

6.1 Protocol Data Units

6.1.1 General

A MAC PDU is a bit string that is byte aligned (i.e. multiple of 8 bits) in length. In the figures in clause 6, bit strings are represented by tables in which the most significant bit is the leftmost bit of the first line of the table, the least significant bit is the rightmost bit on the last line of the table, and more generally the bit string is to be read from left to right and then in the reading order of the lines. The bit order of each parameter field within a MAC PDU is represented with the first and most significant bit in the leftmost bit and the last and least significant bit in the rightmost bit.

A MAC SDU is a bit string that is byte aligned (i.e. multiple of 8 bits) in length. A MAC SDU is included into a MAC PDU from the first bit onward.

A MAC CE is a bit string that is byte aligned (i.e. multiple of 8 bits) in length.

A MAC subheader is a bit string that is byte aligned (i.e. multiple of 8 bits) in length. Each MAC subheader is placed immediately in front of the corresponding MAC SDU, MAC CE, or padding.

The MAC entity shall ignore the value of the Reserved bits in downlink MAC PDUs.

6.1.2 MAC PDU (DL-SCH and UL-SCH except transparent MAC and Random Access Response)

A MAC PDU consists of one or more MAC subPDUs. Each MAC subPDU consists of one of the following:

- A MAC subheader only (including padding);
- A MAC subheader and a MAC SDU;
- A MAC subheader and a MAC CE;
- A MAC subheader and padding.

The MAC SDUs are of variable sizes.

Each MAC subheader corresponds to either a MAC SDU, a MAC CE, or padding.

A MAC subheader except for fixed sized MAC CE, padding, and a MAC SDU containing UL CCCH consists of the four header fields R/F/LCID/L. A MAC subheader for fixed sized MAC CE, padding, and a MAC SDU containing UL CCCH consists of the two header fields R/LCID.

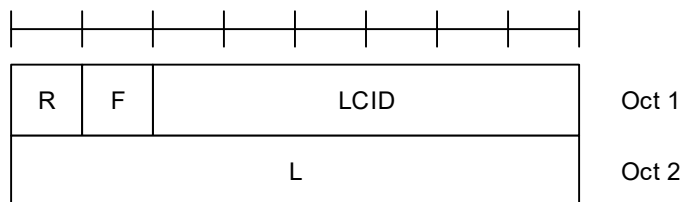

Figure 6.1.2-1: R/F/LCID/L MAC subheader with 8-bit L field

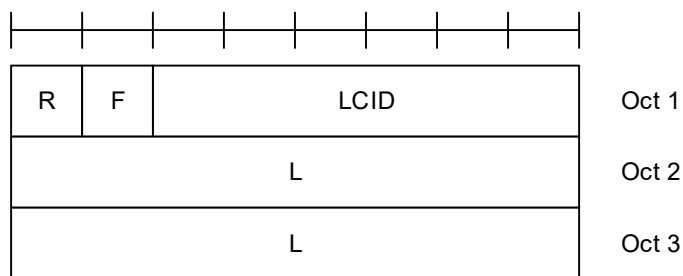

Figure 6.1.2-2: R/F/LCID/L MAC subheader with 16-bit L field

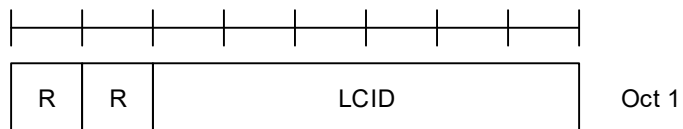

Figure 6.1.2-3: R/LCID MAC subheader

MAC CEs are placed together. DL MAC subPDU(s) with MAC CE(s) is placed before any MAC subPDU with MAC SDU and MAC subPDU with padding as depicted in Figure 6.1.2-4. UL MAC subPDU(s) with MAC CE(s) is placed after all the MAC subPDU(s) with MAC SDU and before the MAC subPDU with padding in the MAC PDU as depicted in Figure 6.1.2-5. The size of padding can be zero.

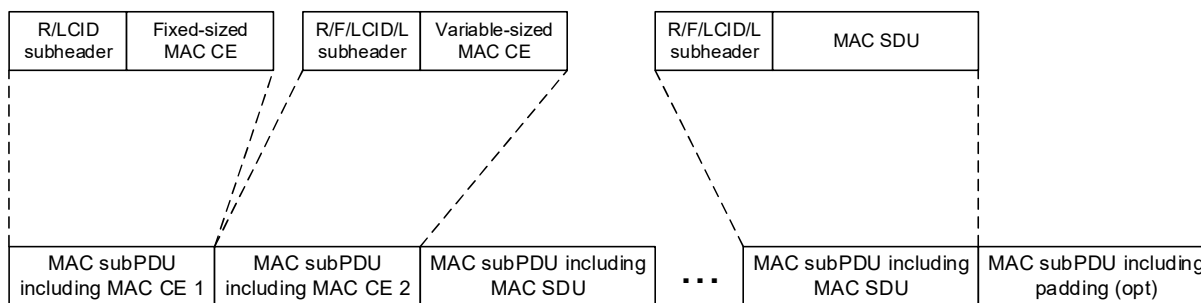

Figure 6.1.2-4: Example of a DL MAC PDU

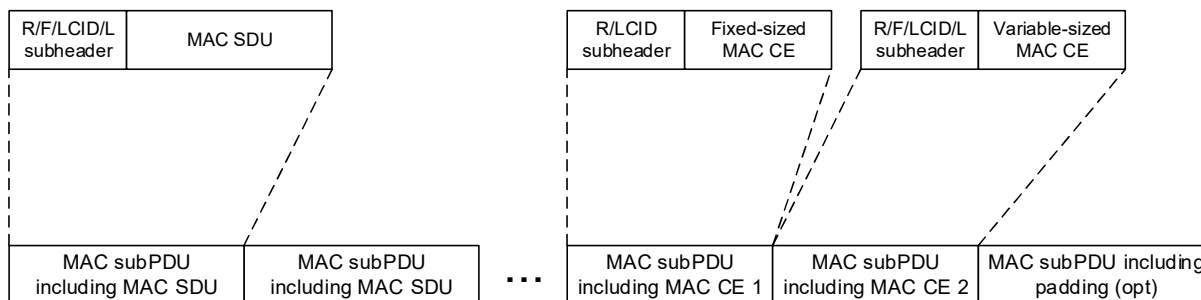

Figure 6.1.2-5: Example of a UL MAC PDU

A maximum of one MAC PDU can be transmitted per TB per MAC entity.

6.1.3 MAC Control Elements (CEs)

6.1.3.1 Buffer Status Report MAC CEs

Buffer Status Report (BSR) MAC CEs consist of either:

- Short BSR format (fixed size); or

- Long BSR format (variable size); or
- Short Truncated BSR format (fixed size); or
- Long Truncated BSR format (variable size).

The BSR formats are identified by MAC PDU subheaders with LCIDs as specified in Table 6.2.1-2.

The fields in the BSR MAC CE are defined as follows:

- LCG ID: The Logical Channel Group ID field identifies the group of logical channel(s) whose buffer status is being reported. The length of the field is 3 bits;
- LCG_i: For the Long BSR format, this field indicates the presence of the Buffer Size field for the logical channel group i. The LCG_i field set to "1" indicates that the Buffer Size field for the logical channel group i is reported. The LCG_i field set to "0" indicates that the Buffer Size field for the logical channel group i is not reported. For the Long Truncated BSR format, this field indicates whether logical channel group i has data available. The LCG_i field set to "1" indicates that logical channel group i has data available. The LCG_i field set to "0" indicates that logical channel group i does not have data available;
- Buffer Size: The Buffer Size field identifies the total amount of data available according to the data volume calculation procedure in TSs 38.322 and 38.323 [3] [4] across all logical channels of a logical channel group after the MAC PDU has been built (i.e. after the logical channel prioritization procedure, which may result the value of the Buffer Size field to zero). The amount of data is indicated in number of bytes. The size of the RLC and MAC headers are not considered in the buffer size computation. The length of this field for the Short BSR format and the Short Truncated BSR format is 5 bits. The length of this field for the Long BSR format and the Long Truncated BSR format is 8 bits. The values for the 5-bit and 8-bit Buffer Size fields are shown in Tables 6.1.3.1-1 and 6.1.3.1-2, respectively. For the Long BSR format and the Long Truncated BSR format, the Buffer Size fields are included in ascending order based on the LCG_i. For the Long Truncated BSR format the number of Buffer Size fields included is maximised, while not exceeding the number of padding bits.

NOTE: The number of the Buffer Size fields in the Long BSR and Long Truncated BSR format can be zero.

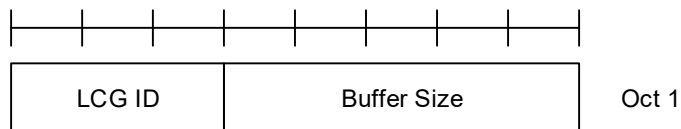

Figure 6.1.3.1-1: Short BSR and Short Truncated BSR MAC CE

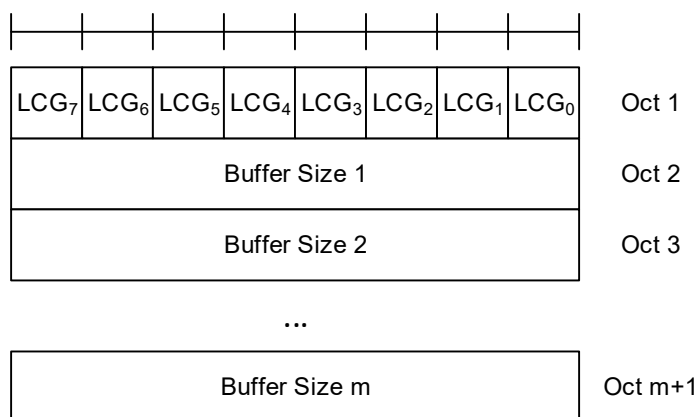

Figure 6.1.3.1-2: Long BSR and Long Truncated BSR MAC CE

Table 6.1.3.1-1: Buffer size levels (in bytes) for 5-bit Buffer Size field

Index	BS value	Index	BS value	Index	BS value	Index	BS value
0	0	8	≤ 102	16	≤ 1446	24	≤ 20516
1	≤ 10	9	≤ 142	17	≤ 2014	25	≤ 28581
2	≤ 14	10	≤ 198	18	≤ 2806	26	≤ 39818
3	≤ 20	11	≤ 276	19	≤ 3909	27	≤ 55474
4	≤ 28	12	≤ 384	20	≤ 5446	28	≤ 77284
5	≤ 38	13	≤ 535	21	≤ 7587	29	≤ 107669
6	≤ 53	14	≤ 745	22	≤ 10570	30	≤ 150000
7	≤ 74	15	≤ 1038	23	≤ 14726	31	> 150000

Table 6.1.3.1-2: Buffer size levels (in bytes) for 8-bit Buffer Size field

Index	BS value	Index	BS value	Index	BS value	Index	BS value
0	0	64	≤ 560	128	≤ 31342	192	≤ 1754595
1	≤ 10	65	≤ 597	129	≤ 33376	193	≤ 1868488
2	≤ 11	66	≤ 635	130	≤ 35543	194	≤ 1989774
3	≤ 12	67	≤ 677	131	≤ 37850	195	≤ 2118933
4	≤ 13	68	≤ 720	132	≤ 40307	196	≤ 2256475
5	≤ 14	69	≤ 767	133	≤ 42923	197	≤ 2402946
6	≤ 15	70	≤ 817	134	≤ 45709	198	≤ 2558924
7	≤ 16	71	≤ 870	135	≤ 48676	199	≤ 2725027
8	≤ 17	72	≤ 926	136	≤ 51836	200	≤ 2901912
9	≤ 18	73	≤ 987	137	≤ 55200	201	≤ 3090279
10	≤ 19	74	≤ 1051	138	≤ 58784	202	≤ 3290873
11	≤ 20	75	≤ 1119	139	≤ 62599	203	≤ 3504487
12	≤ 22	76	≤ 1191	140	≤ 66663	204	≤ 3731968
13	≤ 23	77	≤ 1269	141	≤ 70990	205	≤ 3974215
14	≤ 25	78	≤ 1351	142	≤ 75598	206	≤ 4232186
15	≤ 26	79	≤ 1439	143	≤ 80505	207	≤ 4506902
16	≤ 28	80	≤ 1532	144	≤ 85730	208	≤ 4799451
17	≤ 30	81	≤ 1631	145	≤ 91295	209	≤ 5110989
18	≤ 32	82	≤ 1737	146	≤ 97221	210	≤ 5442750
19	≤ 34	83	≤ 1850	147	≤ 103532	211	≤ 5796046
20	≤ 36	84	≤ 1970	148	≤ 110252	212	≤ 6172275
21	≤ 38	85	≤ 2098	149	≤ 117409	213	≤ 6572925
22	≤ 40	86	≤ 2234	150	≤ 125030	214	≤ 6999582
23	≤ 43	87	≤ 2379	151	≤ 133146	215	≤ 7453933
24	≤ 46	88	≤ 2533	152	≤ 141789	216	≤ 7937777
25	≤ 49	89	≤ 2698	153	≤ 150992	217	≤ 8453028
26	≤ 52	90	≤ 2873	154	≤ 160793	218	≤ 9001725
27	≤ 55	91	≤ 3059	155	≤ 171231	219	≤ 9586039
28	≤ 59	92	≤ 3258	156	≤ 182345	220	≤ 10208280
29	≤ 62	93	≤ 3469	157	≤ 194182	221	≤ 10870913
30	≤ 66	94	≤ 3694	158	≤ 206786	222	≤ 11576557
31	≤ 71	95	≤ 3934	159	≤ 220209	223	≤ 12328006
32	≤ 75	96	≤ 4189	160	≤ 234503	224	≤ 13128233
33	≤ 80	97	≤ 4461	161	≤ 249725	225	≤ 13980403
34	≤ 85	98	≤ 4751	162	≤ 265935	226	≤ 14887889
35	≤ 91	99	≤ 5059	163	≤ 283197	227	≤ 15854280
36	≤ 97	100	≤ 5387	164	≤ 301579	228	≤ 16883401
37	≤ 103	101	≤ 5737	165	≤ 321155	229	≤ 17979324
38	≤ 110	102	≤ 6109	166	≤ 342002	230	≤ 19146385
39	≤ 117	103	≤ 6506	167	≤ 364202	231	≤ 20389201
40	≤ 124	104	≤ 6928	168	≤ 387842	232	≤ 21712690
41	≤ 132	105	≤ 7378	169	≤ 413018	233	≤ 23122088
42	≤ 141	106	≤ 7857	170	≤ 439827	234	≤ 24622972
43	≤ 150	107	≤ 8367	171	≤ 468377	235	≤ 26221280
44	≤ 160	108	≤ 8910	172	≤ 498780	236	≤ 27923336
45	≤ 170	109	≤ 9488	173	≤ 531156	237	≤ 29735875
46	≤ 181	110	≤ 10104	174	≤ 565634	238	≤ 31666069
47	≤ 193	111	≤ 10760	175	≤ 602350	239	≤ 33721553
48	≤ 205	112	≤ 11458	176	≤ 641449	240	≤ 35910462
49	≤ 218	113	≤ 12202	177	≤ 683087	241	≤ 38241455
50	≤ 233	114	≤ 12994	178	≤ 727427	242	≤ 40723756
51	≤ 248	115	≤ 13838	179	≤ 774645	243	≤ 43367187
52	≤ 264	116	≤ 14736	180	≤ 824928	244	≤ 46182206
53	≤ 281	117	≤ 15692	181	≤ 878475	245	≤ 49179951
54	≤ 299	118	≤ 16711	182	≤ 935498	246	≤ 52372284
55	≤ 318	119	≤ 17795	183	≤ 996222	247	≤ 55771835
56	≤ 339	120	≤ 18951	184	≤ 1060888	248	≤ 59392055
57	≤ 361	121	≤ 20181	185	≤ 1129752	249	≤ 63247269
58	≤ 384	122	≤ 21491	186	≤ 1203085	250	≤ 67352729
59	≤ 409	123	≤ 22885	187	≤ 1281179	251	≤ 71724679
60	≤ 436	124	≤ 24371	188	≤ 1364342	252	≤ 76380419
61	≤ 464	125	≤ 25953	189	≤ 1452903	253	≤ 81338368

62	≤ 494	126	≤ 27638	190	≤ 1547213	254	> 81338368
63	≤ 526	127	≤ 29431	191	≤ 1647644	255	Reserved

6.1.3.2 C-RNTI MAC CE

The C-RNTI MAC CE is identified by MAC PDU subheader with LCID as specified in Table 6.2.1-2.

It has a fixed size and consists of a single field defined as follows (Figure 6.1.3.2-1):

- C-RNTI: This field contains the C-RNTI of the MAC entity. The length of the field is 16 bits.

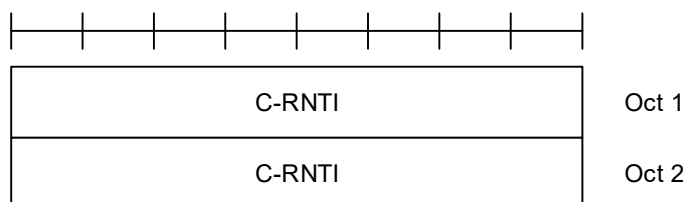

Figure 6.1.3.2-1: C-RNTI MAC CE

6.1.3.3 UE Contention Resolution Identity MAC CE

The UE Contention Resolution Identity MAC CE is identified by MAC PDU subheader with LCID as specified in Table 6.2.1-1.

It has a fixed 48-bit size and consists of a single field defined as follows (Figure 6.1.3.3-1):

- UE Contention Resolution Identity: This field contains the UL CCCH SDU. If the UL CCCH SDU is longer than 48 bits, this field contains the first 48 bits of the UL CCCH SDU.

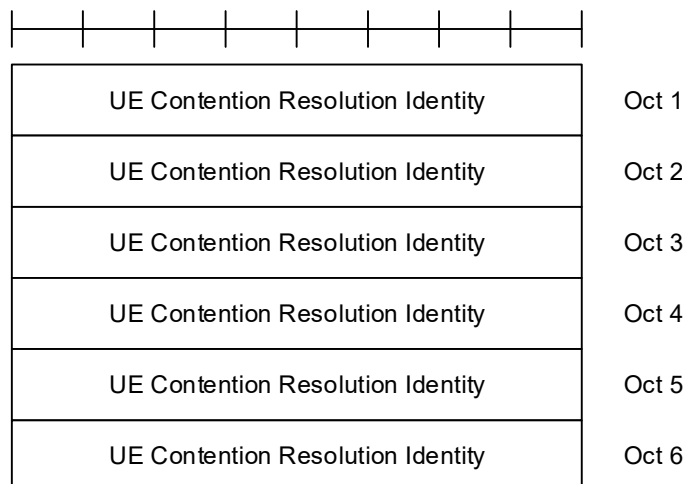

Figure 6.1.3.3-1: UE Contention Resolution Identity MAC CE

6.1.3.4 Timing Advance Command MAC CE

The Timing Advance Command MAC CE is identified by MAC PDU subheader with LCID as specified in Table 6.2.1-1.

It has a fixed size and consists of a single octet defined as follows (Figure 6.1.3.4-1):

- TAG Identity (TAG ID): This field indicates the TAG Identity of the addressed TAG. The TAG containing the SpCell has the TAG Identity 0. The length of the field is 2 bits;

- Timing Advance Command: This field indicates the index value T_A (0, 1, 2... 63) used to control the amount of timing adjustment that MAC entity has to apply (as specified in TS 38.213 [6]). The length of the field is 6 bits.

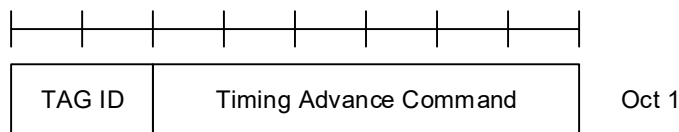

Figure 6.1.3.4-1: Timing Advance Command MAC CE

6.1.3.5 DRX Command MAC CE

The DRX Command MAC CE is identified by a MAC PDU subheader with LCID as specified in Table 6.2.1-1.

It has a fixed size of zero bits.

6.1.3.6 Long DRX Command MAC CE

The Long DRX Command MAC CE is identified by a MAC PDU subheader with LCID as specified in Table 6.2.1-1.

It has a fixed size of zero bits.

6.1.3.7 Configured Grant Confirmation MAC CE

The Configured Grant Confirmation MAC CE is identified by a MAC PDU subheader with LCID as specified in Table 6.2.1-2.

It has a fixed size of zero bits.

6.1.3.8 Single Entry PHR MAC CE

The Single Entry PHR MAC CE is identified by a MAC PDU subheader with LCID as specified in Table 6.2.1-2.

It has a fixed size and consists of two octet defined as follows (figure 6.1.3.8-1):

- R: Reserved bit, set to "0";
- Power Headroom (PH): This field indicates the power headroom level. The length of the field is 6 bits. The reported PH and the corresponding power headroom levels are shown in Table 6.1.3.8-1 below (the corresponding measured values in dB are specified in TS 38.133 [11]);
- $P_{\text{CMAX},f,c}$: This field indicates the $P_{\text{CMAX},f,c}$ (as specified in TS 38.213 [6]) used for calculation of the preceding PH field. The reported $P_{\text{CMAX},f,c}$ and the corresponding nominal UE transmit power levels are shown in Table 6.1.3.8-2 (the corresponding measured values in dBm are specified in TS 38.133 [11]).

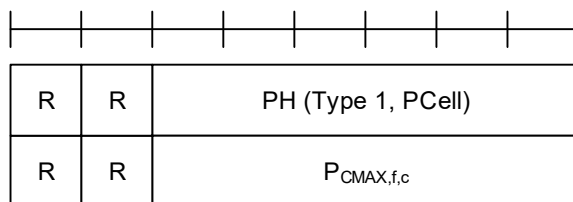

Figure 6.1.3.8-1: Single Entry PHR MAC CE

Table 6.1.3.8-1: Power Headroom levels for PHR

PH	Power Headroom Level
0	POWER_HEADROOM_0
1	POWER_HEADROOM_1
2	POWER_HEADROOM_2
3	POWER_HEADROOM_3
...	...
60	POWER_HEADROOM_60
61	POWER_HEADROOM_61
62	POWER_HEADROOM_62
63	POWER_HEADROOM_63

Table 6.1.3.8-2: Nominal UE transmit power level for PHR

$P_{\text{CMAX},f,c}$	Nominal UE transmit power level
0	PCMAX_C_00
1	PCMAX_C_01
2	PCMAX_C_02
...	...
61	PCMAX_C_61
62	PCMAX_C_62
63	PCMAX_C_63

6.1.3.9 Multiple Entry PHR MAC CE

The Multiple Entry PHR MAC CE is identified by a MAC PDU subheader with LCID as specified in Table 6.2.1-2.

It has a variable size, and includes the bitmap, a Type 2 PH field and an octet containing the associated $P_{\text{CMAX},f,c}$ field (if reported) for SpCell of the other MAC entity, a Type 1 PH field and an octet containing the associated $P_{\text{CMAX},f,c}$ field (if reported) for the PCell. It further includes, in ascending order based on the *ServCellIndex*, one or multiple of Type X PH fields and octets containing the associated $P_{\text{CMAX},f,c}$ fields (if reported) for Serving Cells other than PCell indicated in the bitmap. X is either 1 or 3 according to TS 38.213 [6].

The presence of Type 2 PH field for SpCell of the other MAC entity is configured by *phr-Type2OtherCell* with value TRUE.

A single octet bitmap is used for indicating the presence of PH per Serving Cell when the highest *ServCellIndex* of Serving Cell with configured uplink is less than 8, otherwise four octets are used.

The MAC entity determines whether PH value for an activated Serving Cell is based on real transmission or a reference format by considering the downlink control information which has been received until and including the PDCCH occasion in which the first UL grant for a new transmission is received since a PHR has been triggered.

The PHR MAC CEs are defined as follows:

- C_i : This field indicates the presence of a PH field for the Serving Cell with *ServCellIndex* i as specified in TS 38.331 [5]. The C_i field set to "1" indicates that a PH field for the Serving Cell with *ServCellIndex* i is reported. The C_i field set to "0" indicates that a PH field for the Serving Cell with *ServCellIndex* i is not reported;
- R: Reserved bit, set to "0";
- V: This field indicates if the PH value is based on a real transmission or a reference format. For Type 1 PH, V=0 indicates real transmission on PUSCH and V=1 indicates that a PUSCH reference format is used. For Type 2 PH, V=0 indicates real transmission on PUCCH and V=1 indicates that a PUCCH reference format is used. For Type 3 PH, V=0 indicates real transmission on SRS and V=1 indicates that an SRS reference format is used. Furthermore, for Type 1, Type 2, and Type 3 PH, V=0 indicates the presence of the octet containing the associated $P_{\text{CMAX},f,c}$ field, and V=1 indicates that the octet containing the associated $P_{\text{CMAX},f,c}$ field is omitted;

- Power Headroom (PH): This field indicates the power headroom level. The length of the field is 6 bits. The reported PH and the corresponding power headroom levels are shown in Table 6.1.3.8-1 (the corresponding measured values in dB for the NR Serving Cell are specified in TS 38.133 [11] while the corresponding measured values in dB for the E-UTRA Serving Cell are specified in TS 36.133 [12]);
- P: This field indicates whether the MAC entity applies power backoff due to power management. The MAC entity shall set P=1 if the corresponding $P_{\text{CMAX},f,c}$ field would have had a different value if no power backoff due to power management had been applied;
- $P_{\text{CMAX},f,c}$: If present, this field indicates the $P_{\text{CMAX},f,c}$ or $\tilde{P}_{\text{CMAX},f,c}$ (as specified in TS 38.213 [6]) used for calculation of the preceding PH field. The reported $P_{\text{CMAX},f,c}$ and the corresponding nominal UE transmit power levels are shown in Table 6.1.3.8-2 (the corresponding measured values in dBm for the NR Serving Cell are specified in TS 38.133 [11] while the corresponding measured values in dBm for the E-UTRA Serving Cell are specified in TS 36.133 [12]).

C ₇	C ₆	C ₅	C ₄	C ₃	C ₂	C ₁	R
P	V	PH (Type 2, SpCell of the other MAC entity)					
R	R	$P_{\text{CMAX},f,c} 1$					
P	V	PH (Type 1, PCell)					
R	R	$P_{\text{CMAX},f,c} 2$					
P	V	PH (Type X, Serving Cell 1)					
R	R	$P_{\text{CMAX},f,c} 3$					
...							
P	V	PH (Type X, Serving Cell n)					
R	R	$P_{\text{CMAX},f,c} m$					

Figure 6.1.3.9-1: Multiple Entry PHR MAC CE with the highest *ServCellIndex* of Serving Cell with configured uplink is less than 8

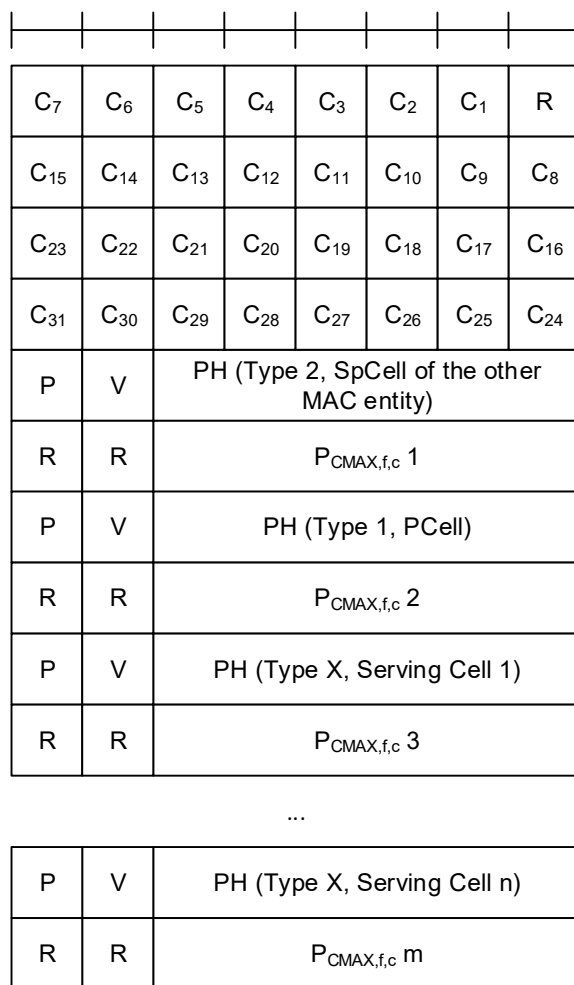

Figure 6.1.3.9-2: Multiple Entry PHR MAC CE with the highest ServCellIndex of Serving Cell with configured uplink is equal to or higher than 8

6.1.3.10 SCell Activation/Deactivation MAC CEs

The SCell Activation/Deactivation MAC CE of one octet is identified by a MAC PDU subheader with LCID as specified in Table 6.2.1-1. It has a fixed size and consists of a single octet containing seven C-fields and one R-field. The SCell Activation/Deactivation MAC CE with one octet is defined as follows (Figure 6.1.3.10-1).

The SCell Activation/Deactivation MAC CE of four octets is identified by a MAC PDU subheader with LCID as specified in Table 6.2.1-1. It has a fixed size and consists of four octets containing 31 C-fields and one R-field. The SCell Activation/Deactivation MAC CE of four octets is defined as follows (Figure 6.1.3.10-2).

- C_i: If there is an SCell configured for the MAC entity with *SCellIndex* i as specified in TS 38.331 [5], this field indicates the activation/deactivation status of the SCell with *SCellIndex* i, else the MAC entity shall ignore the C_i field. The C_i field is set to "1" to indicate that the SCell with *SCellIndex* i shall be activated. The C_i field is set to "0" to indicate that the SCell with *SCellIndex* i shall be deactivated;
- R: Reserved bit, set to "0".

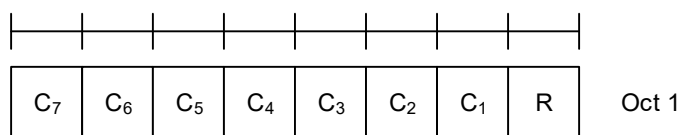

Figure 6.1.3.10-1: SCell Activation/Deactivation MAC CE of one octet

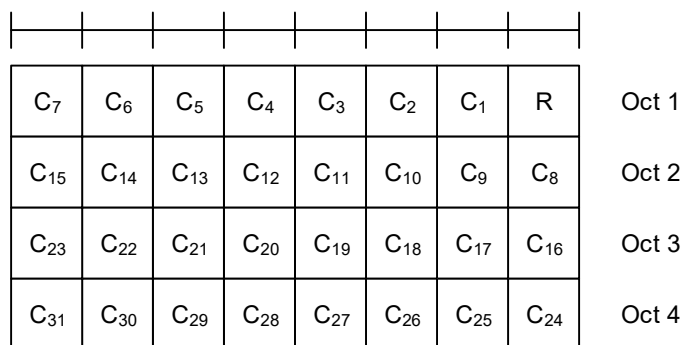

Figure 6.1.3.10-2: SCell Activation/Deactivation MAC CE of four octets

6.1.3.11 Duplication Activation/Deactivation MAC CE

The Duplication Activation/Deactivation MAC CE of one octet is identified by a MAC PDU subheader with LCID as specified in Table 6.2.1-1. It has a fixed size and consists of a single octet containing eight D-fields. The Duplication Activation/Deactivation MAC CE is defined, for a MAC entity, as follows (Figure 6.1.3.11-1).

- D_i: This field indicates the activation/deactivation status of the PDCP duplication of DRB i where i is the ascending order of the DRB ID among the DRBs configured with PDCP duplication and with RLC entity(ies) associated with this MAC entity. The D_i field is set to one to indicate that the PDCP duplication of DRB i shall be activated. The D_i field is set to zero to indicate that the PDCP duplication of DRB i shall be deactivated.

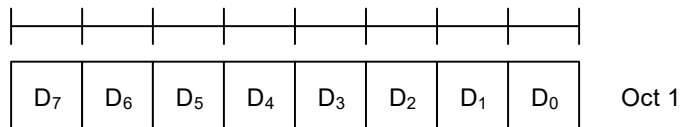

Figure 6.1.3.11-1: Duplication Activation/Deactivation MAC CE

6.1.3.12 SP CSI-RS / CSI-IM Resource Set Activation/Deactivation MAC CE

The SP CSI-RS / CSI-IM Resource Set Activation/Deactivation MAC CE is identified by a MAC PDU subheader with LCID as specified in Table 6.2.1-1. It has a variable size and consists of the following fields:

- A/D: This field indicates whether the MAC CE is used to activate or deactivate indicated SP CSI-RS and CSI-IM resource set(s). The field is set to "1" to indicate activation, otherwise it indicates deactivation;
- Serving Cell ID: This field indicates the identity of the Serving Cell for which the MAC CE applies. The length of the field is 5 bits;
- BWP ID: This field contains *BWP-Id*, as specified in TS 38.331 [5], of a downlink bandwidth part for which the MAC CE applies. The length of the BWP ID field is 2 bits;
- SP CSI-RS resource set ID: This field contains an index of *NZP-CSI-RS-ResourceSet* containing Semi Persistent NZP CSI-RS resources, as specified in TS 38.331 [5], indicating the Semi Persistent NZP CSI-RS resource set, which should be activated or deactivated. The length of the field is 6 bits;
- IM: This field indicates whether SP CSI-IM resource set indicated with SP CSI-IM resource set ID field should be activated/deactivated. If IM field is set to "1", SP CSI-IM resource set should be activated or deactivated (depending on A/D field setting). If IM field is set to "0", the octet containing SP CSI-IM resource set ID field is not present;
- SP CSI-IM resource set ID: This field contains an index of *CSI-IM-ResourceSet* containing Semi Persistent CSI-IM resources, as specified in TS 38.331 [5], indicating the Semi Persistent CSI-IM resource set, which should be activated or deactivated. The length of the field is 6 bits;
- TCI State ID: This field contains *TCI-StateId*, as specified in TS 38.331 [5], of a TCI State, which is used as QCL source for the resource within the Semi Persistent NZP CSI-RS resource set indicated by SP CSI-RS

resource set ID field. TCI State ID₀ indicates TCI State for the first resource within the set, TCI State ID₁ for the second one and so on. The length of the field is 7 bits. If A/D field is set to "0" then the octet containing this field is not present;

- R: Reserved bit, set to "0".

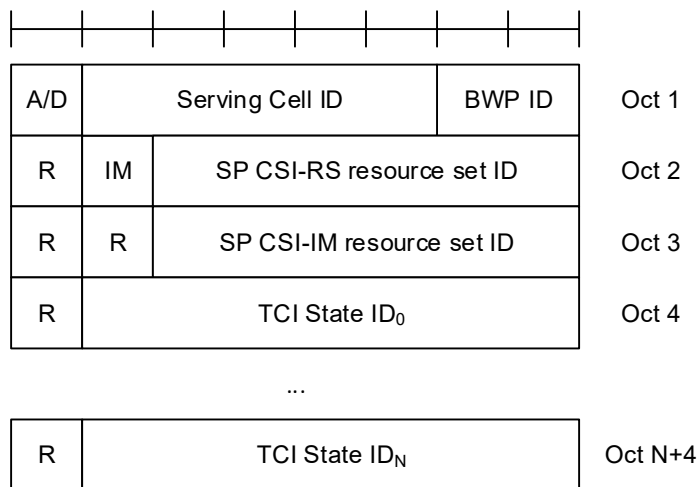

Figure 6.1.3.12-1: SP CSI-RS / CSI-IM Resource Set Activation/Deactivation MAC CE

6.1.3.13 Aperiodic CSI Trigger State Subselection MAC CE

The Aperiodic CSI Trigger State Subselection MAC CE is identified by a MAC PDU subheader with LCID as specified in Table 6.2.1-1. It has a variable size consisting of following fields:

- Serving Cell ID: This field indicates the identity of the Serving Cell for which the MAC CE applies. The length of the field is 5 bits;
- BWP ID: This field contains *BWP-Id*, as specified in TS 38.331 [5], of a downlink bandwidth part for which the MAC CE applies. The length of the BWP ID field is 2 bits;
- T_i: This field indicates the selection status of the Aperiodic Trigger States configured within *CSI-aperiodicTriggerStateList*, as specified in TS 38.331 [5]. T₀ refers to the first trigger state within the list, T₁ to the second one and so on. If the list does not contain entry with index *i*, MAC entity shall ignore the T_i field. The T_i field is set to "1" to indicate that the Aperiodic Trigger State *i* shall be mapped to the codepoint of the DCI *CSI request* field, as specified in TS 38.214 [7]. The codepoint to which the Aperiodic Trigger State is mapped is determined by its ordinal position among all the Aperiodic Trigger States with T_i field set to "1", i.e. the first Aperiodic Trigger State with T_i field set to "1" shall be mapped to the codepoint value 1, second Aperiodic Trigger State with T_i field set to "1" shall be mapped to the codepoint value 2 and so on. The maximum number of mapped Aperiodic Trigger States is 63;
- R: Reserved bit, set to "0".

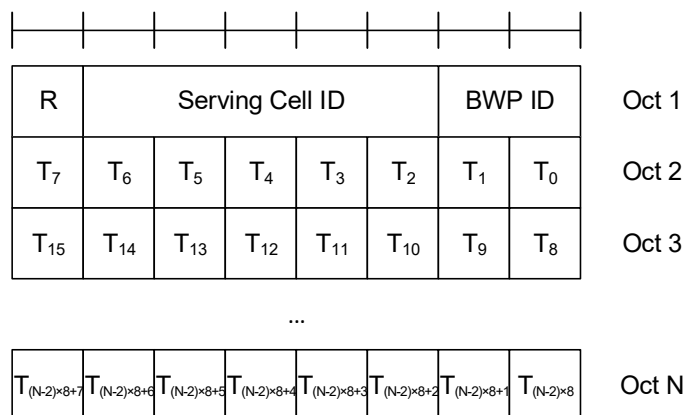

Figure 6.1.3.13-1: Aperiodic CSI Trigger State Subselection MAC CE

6.1.3.14 TCI States Activation/Deactivation for UE-specific PDSCH MAC CE

The TCI States Activation/Deactivation for UE-specific PDSCH MAC CE is identified by a MAC PDU subheader with LCID as specified in Table 6.2.1-1. It has a variable size consisting of following fields:

- Serving Cell ID: This field indicates the identity of the Serving Cell for which the MAC CE applies. The length of the field is 5 bits;
- BWP ID: This field contains *BWP-Id*, as specified in TS 38.331 [5], of a downlink bandwidth part for which the MAC CE applies. The length of the BWP ID field is 2 bits;
- T_i: If there is a TCI state with *TCI-StateId* *i* as specified in TS 38.331 [5], this field indicates the activation/deactivation status of the TCI state with *TCI-StateId* *i*, otherwise MAC entity shall ignore the T_i field. The T_i field is set to "1" to indicate that the TCI state with *TCI-StateId* *i* shall be activated and mapped to the codepoint of the DCI *Transmission Configuration Indication* field, as specified in TS 38.214 [7]. The T_i field is set to "0" to indicate that the TCI state with *TCI-StateId* *i* shall be deactivated and is not mapped to the codepoint of the DCI *Transmission Configuration Indication* field. The codepoint to which the TCI State is mapped is determined by its ordinal position among all the TCI States with T_i field set to "1", i.e. the first TCI State with T_i field set to "1" shall be mapped to the codepoint value 0, second TCI State with T_i field set to "1" shall be mapped to the codepoint value 1 and so on. The maximum number of activated TCI states is 8;
- R: Reserved bit, set to "0".

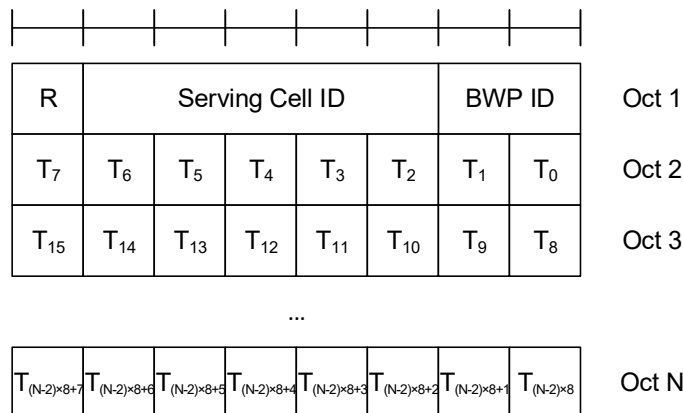

Figure 6.1.3.14-1: TCI States Activation/Deactivation for UE-specific PDSCH MAC CE

6.1.3.15 TCI State Indication for UE-specific PDCCH MAC CE

The TCI State Indication for UE-specific PDCCH MAC CE is identified by a MAC PDU subheader with LCID as specified in Table 6.2.1-1. It has a fixed size of 16 bits with following fields:

- Serving Cell ID: This field indicates the identity of the Serving Cell for which the MAC CE applies. The length of the field is 5 bits;
- CORESET ID: This field indicates a Control Resource Set identified with *ControlResourceSetId* as specified in TS 38.331 [5], for which the TCI State is being indicated. The length of the field is 4 bits;
- TCI State ID: This field indicates the TCI state identified by *TCI-StateId* as specified in TS 38.331 [5] applicable to the Control Resource Set identified by CORESET ID field. The length of the field is 7 bits.

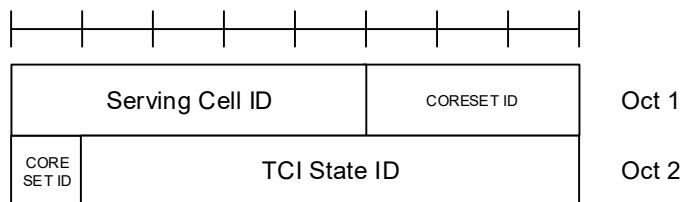

Figure 6.1.3.15-1: TCI State Indication for UE-specific PDCCH MAC CE

6.1.3.16 SP CSI reporting on PUCCH Activation/Deactivation MAC CE

The SP CSI reporting on PUCCH Activation/Deactivation MAC CE is identified by a MAC PDU subheader with LCID as specified in Table 6.2.1-1. It has a fixed size of 16 bits with following fields:

- Serving Cell ID: This field indicates the identity of the Serving Cell for which the MAC CE applies. The length of the field is 5 bits;
- BWP ID: This field contains *BWP-Id*, as specified in TS 38.331 [5], of a uplink bandwidth part for which the MAC CE applies. The length of the BWP ID field is 2 bits;
- S_i : This field indicates the activation/deactivation status of the Semi-Persistent CSI report configuration within *csi-ReportConfigToAddModList*, as specified in TS 38.331 [5]. S_0 refers to the report configuration which includes PUCCH resources for SP CSI reporting in the indicated BWP and has the lowest *CSI-ReportConfigId* within the list with type set to "*semiPersistentOnPUCCH*", S_1 to the report configuration which includes PUCCH resources for SP CSI reporting in the indicated BWP and has the second lowest *CSI-ReportConfigId* and so on. If the number of report configurations within the list with type set to "*semiPersistentOnPUCCH*" in the indicated BWP is less than $i + 1$, MAC entity shall ignore the S_i field. The S_i field is set to "1" to indicate that the corresponding Semi-Persistent CSI report configuration shall be activated. The S_i field is set to "0" to indicate that the corresponding Semi-Persistent CSI report configuration i shall be deactivated;
- R: Reserved bit, set to "0".

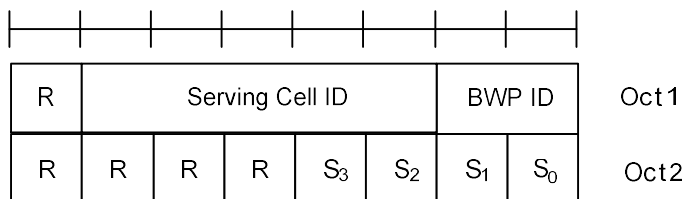

Figure 6.1.3.16-1: SP CSI reporting on PUCCH Activation/Deactivation MAC CE

6.1.3.17 SP SRS Activation/Deactivation MAC CE

The SP SRS Activation/Deactivation MAC CE is identified by a MAC PDU subheader with LCID as specified in Table 6.2.1-1. It has a variable size with following fields:

- A/D: This field indicates whether the MAC CE is used to activate or deactivate indicated SP SRS resource set. The field is set to "1" to indicate activation, otherwise it indicates deactivation;
- SRS Resource Set's Cell ID: This field indicates the identity of the Serving Cell, which contains activated/deactivated SP SRS Resource Set. The length of the field is 5 bits;

- SRS Resource Set's BWP ID: This field contains *BWP-Id*, as specified in TS 38.331 [5], of an uplink bandwidth part, which contains activated/deactivated SP SRS Resource Set. The length of the field is 2 bits;
- C: This field indicates whether the octets containing Resource Serving Cell ID field(s) and Resource BWP ID field(s) are present. If this field is set to "1", the octets containing Resource Serving Cell ID field(s) and Resource BWP ID field(s) are present. If this field is set to "0", they are not present and all resources indicated in the Resource ID_i fields are located on the Serving Cell and BWP indicated by SRS Resource Set's cell ID and SRS Resource Set's BWP ID fields;
- SUL: This field indicates whether the MAC CE applies to the NUL carrier or SUL carrier configuration. This field is set to "1" to indicate it applies to the SUL carrier configuration, it is set to "0" to indicate it applies to the NUL carrier configuration;
- SP SRS Resource Set ID: This field indicates the SP SRS Resource Set ID identified by *SRS-ResourceSetId* as specified in TS 38.331 [5], which is to be activated or deactivated. The length of the field is 4 bits;
- F_i: This field indicates the type of a resource used as a spatial relationship for SRS resource within SP SRS Resource Set indicated with SP SRS Resource Set ID field. F₀ refers to the first SRS resource within the resource set, F₁ to the second one and so on. The field is set to "1" to indicate NZP CSI-RS resource index is used, it is set to "0" to indicate either SSB index or SRS resource index is used. The length of the field is 1 bit. This field is only present if MAC CE is used for activation, i.e. A/D field is set to "1";
- Resource ID_i: This field contains an identifier of the resource used for spatial relationship derivation for SRS resource *i*. Resource ID₀ refers to the first SRS resource within the resource set, Resource ID₁ to the second one and so on. If F_i is set to "0" and the first bit of this field is set to "1", then the remainder of this field contains *SSB-Index* as specified in TS 38.331 [5], if F_i is set to "0" and the first bit of this field is set to "0" then the remainder this field contains *SRS-ResourceId* as specified in TS 38.331 [5]. The length of the field is 7 bits. This field is only present if MAC CE is used for activation, i.e. A/D field is set to "1";
- Resource Serving Cell ID_i: This field indicates the identity of the Serving Cell on which the resource used for spatial relationship derivation for SRS resource *i* is located. The length of the field is 5 bits;
- Resource BWP ID_i: This field contains *BWP-Id*, as specified in TS 38.331 [5], of an uplink bandwidth part on which the resource used for spatial relationship derivation for SRS resource *i* is located. The length of the field is 2 bits;
- R: Reserved bit, set to "0".

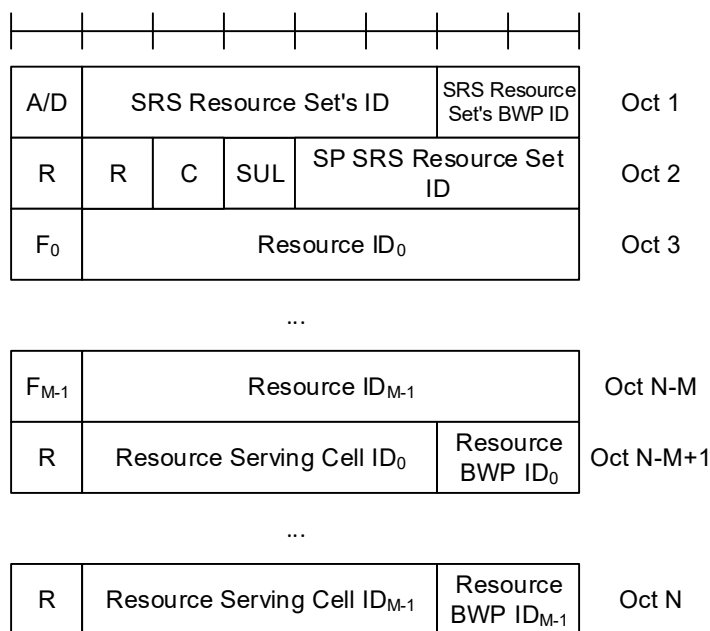

Figure 6.1.3.17-1: SP SRS Activation/Deactivation MAC CE

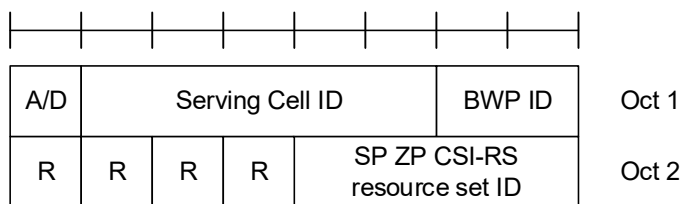

Figure 6.1.3.19-1: SP ZP CSI-RS Resource Set Activation/Deactivation MAC CE

6.1.3.20 Recommended bit rate MAC CE

The Recommended bit rate MAC CE is identified by a MAC PDU subheader with LCID as specified in Tables 6.2.1-1 and 6.2.1-2 for bit rate recommendation message from the gNB to the UE and bit rate recommendation query message from the UE to the gNB, respectively. It has a fixed size and consists of two octets defined as follows (Figure 6.1.3.20-1):

- LCID: This field indicates the identity of the logical channel for which the recommended bit rate or the recommended bit rate query is applicable. The length of the field is 6 bits;
- Uplink/Downlink (UL/DL): This field indicates whether the recommended bit rate or the recommended bit rate query applies to uplink or downlink. The length of the field is 1 bit. The UL/DL field set to "0" indicates downlink. The UL/DL field set to "1" indicates uplink;
- Bit Rate: This field indicates an index to Table 6.1.3.20-1. The length of the field is 6 bits. For bit rate recommendation the value indicates the recommended bit rate. For bit rate recommendation query the value indicates the desired bit rate;
- R: reserved bit, set to "0".

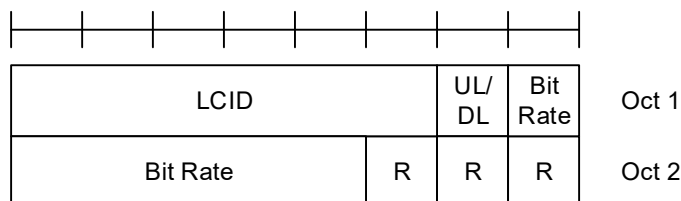

Figure 6.1.3.20-1: Recommended bit rate MAC CE

Table 6.1.3.20-1: Values (kbit/s) for Bit Rate field

Index	NR Recommended Bit Rate value [kbit/s]	Index	NR Recommended Bit Rate value [kbit/s]
0		32	700
1	0	33	800
2	9	34	900
3	11	35	1000
4	13	36	1100
5	17	37	1200
6	21	38	1300
7	25	39	1400
8	29	40	1500
9	32	41	1750
10	36	42	2000
11	40	43	2250
12	48	44	2500
13	56	45	2750
14	72	46	3000
15	88	47	3500
16	104	48	4000
17	120	49	4500
18	140	50	5000
19	160	51	5500
20	180	52	6000
21	200	53	6500
22	220	54	7000
23	240	55	7500
24	260	56	8000
25	280	57	Reserved
26	300	58	Reserved
27	350	59	Reserved
28	400	60	Reserved
29	450	61	Reserved
30	500	62	Reserved
31	600	63	Reserved

6.1.4 MAC PDU (transparent MAC)

A MAC PDU consists solely of a MAC SDU whose size is aligned to a TB; as described in Figure 6.1.4-1. This MAC PDU is used for transmissions on PCH, BCH, and DL-SCH including BCCH.

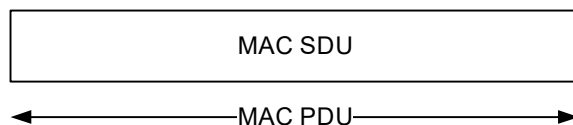

Figure 6.1.4-1: Example of MAC PDU (transparent MAC)

6.1.5 MAC PDU (Random Access Response)

A MAC PDU consists of one or more MAC subPDUs and optionally padding. Each MAC subPDU consists one of the following:

- a MAC subheader with Backoff Indicator only;
- a MAC subheader with RAPID only (i.e. acknowledgment for SI request);
- a MAC subheader with RAPID and MAC RAR.

A MAC subheader with Backoff Indicator consists of five header fields E/T/R/R/BI as described in Figure 6.1.5-1. A MAC subPDU with Backoff Indicator only is placed at the beginning of the MAC PDU, if included. 'MAC subPDU(s) with RAPID only' and 'MAC subPDU(s) with RAPID and MAC RAR' can be placed anywhere between MAC subPDU with Backoff Indicator only (if any) and padding (if any).

A MAC subheader with RAPID consists of three header fields E/T/RAPID as described in Figure 6.1.5-2.

Padding is placed at the end of the MAC PDU if present. Presence and length of padding is implicit based on TB size, size of MAC subPDU(s).

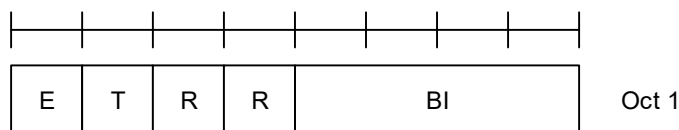

Figure 6.1.5-1: E/T/R/R/BI MAC subheader

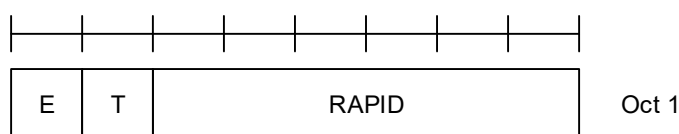

Figure 6.1.5-2: E/T/RAPID MAC subheader

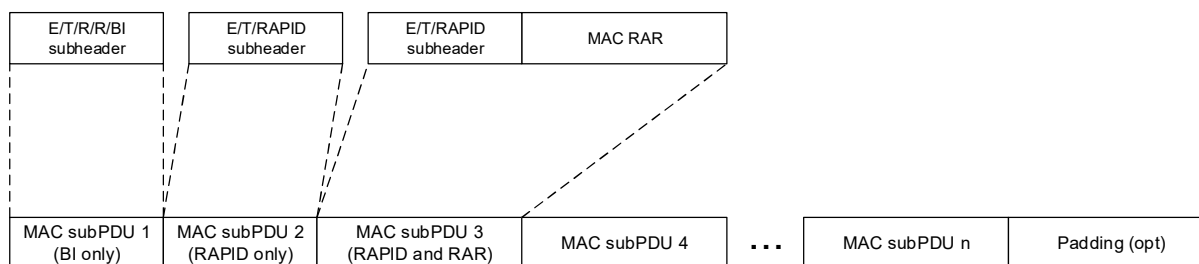

Figure 6.1.5-3: Example of MAC PDU consisting of MAC RARs

6.2 Formats and parameters

6.2.1 MAC subheader for DL-SCH and UL-SCH

The MAC subheader consists of the following fields:

- LCID: The Logical Channel ID field identifies the logical channel instance of the corresponding MAC SDU or the type of the corresponding MAC CE or padding as described in Tables 6.2.1-1 and 6.2.1-2 for the DL-SCH and UL-SCH respectively. There is one LCID field per MAC subheader. The LCID field size is 6 bits;
- L: The Length field indicates the length of the corresponding MAC SDU or variable-sized MAC CE in bytes. There is one L field per MAC subheader except for subheaders corresponding to fixed-sized MAC CEs, padding, and MAC SDUs containing UL CCCH. The size of the L field is indicated by the F field;
- F: The Format field indicates the size of the Length field. There is one F field per MAC subheader except for subheaders corresponding to fixed-sized MAC CEs, padding, and MAC SDUs containing UL CCCH. The size of the F field is 1 bit. The value 0 indicates 8 bits of the Length field. The value 1 indicates 16 bits of the Length field;
- R: Reserved bit, set to zero.

The MAC subheader is octet aligned.

Table 6.2.1-1 Values of LCID for DL-SCH

Index	LCID values
0	CCCH
1–32	Identity of the logical channel
33–46	Reserved
47	Recommended bit rate
48	SP ZP CSI-RS Resource Set Activation/Deactivation
49	PUCCH spatial relation Activation/Deactivation
50	SP SRS Activation/Deactivation
51	SP CSI reporting on PUCCH Activation/Deactivation
52	TCI State Indication for UE-specific PDCCH
53	TCI States Activation/Deactivation for UE- specific PDSCH
54	Aperiodic CSI Trigger State Subselection
55	SP CSI-RS / CSI-IM Resource Set Activation/Deactivation
56	Duplication Activation/Deactivation
57	SCell Activation/Deactivation (four octet)
58	SCell Activation/Deactivation (one octet)
59	Long DRX Command
60	DRX Command
61	Timing Advance Command
62	UE Contention Resolution Identity
63	Padding

Table 6.2.1-2 Values of LCID for UL-SCH

Index	LCID values
0	CCCH of size 64 bits
1–32	Identity of the logical channel
33–51	Reserved
52	CCCH of size 48 bits
53	Recommended bit rate query
54	Multiple Entry PHR (four octet C _i)
55	Configured Grant Confirmation
56	Multiple Entry PHR (one octet C _i)
57	Single Entry PHR
58	C-RNTI
59	Short Truncated BSR
60	Long Truncated BSR
61	Short BSR
62	Long BSR
63	Padding

6.2.2 MAC subheader for Random Access Response

The MAC subheader consists of the following fields:

- E: The Extension field is a flag indicating if the MAC subPDU including this MAC subheader is the last MAC subPDU or not in the MAC PDU. The E field is set to "1" to indicate at least another MAC subPDU follows. The E field is set to "0" to indicate that the MAC subPDU including this MAC subheader is the last MAC subPDU in the MAC PDU;
- T: The Type field is a flag indicating whether the MAC subheader contains a Random Access Preamble ID or a Backoff Indicator. The T field is set to "0" to indicate the presence of a Backoff Indicator field in the subheader (BI). The T field is set to "1" to indicate the presence of a Random Access Preamble ID field in the subheader (RAPID);

- R: Reserved bit, set to "0";
- BI: The Backoff Indicator field identifies the overload condition in the cell. The size of the BI field is 4 bits;
- RAPID: The Random Access Preamble IDentifier field identifies the transmitted Random Access Preamble (see subclause 5.1.3). The size of the RAPID field is 6 bits. If the RAPID in the MAC subheader of a MAC subPDU corresponds to one of the Random Access Preambles configured for SI request, MAC RAR is not included in the MAC subPDU.

The MAC subheader is octet aligned.

6.2.3 MAC payload for Random Access Response

The MAC RAR is of fixed size as depicted in Figure 6.2.3-1, and consists of the following fields:

- R: Reserved bit, set to "0";
- Timing Advance Command: The Timing Advance Command field indicates the index value T_A used to control the amount of timing adjustment that the MAC entity has to apply in TS 38.213 [6]. The size of the Timing Advance Command field is 12 bits;
- UL Grant: The Uplink Grant field indicates the resources to be used on the uplink in TS 38.213 [6]. The size of the UL Grant field is 27 bits;
- Temporary C-RNTI: The Temporary C-RNTI field indicates the temporary identity that is used by the MAC entity during Random Access. The size of the Temporary C-RNTI field is 16 bits.

The MAC RAR is octet aligned.

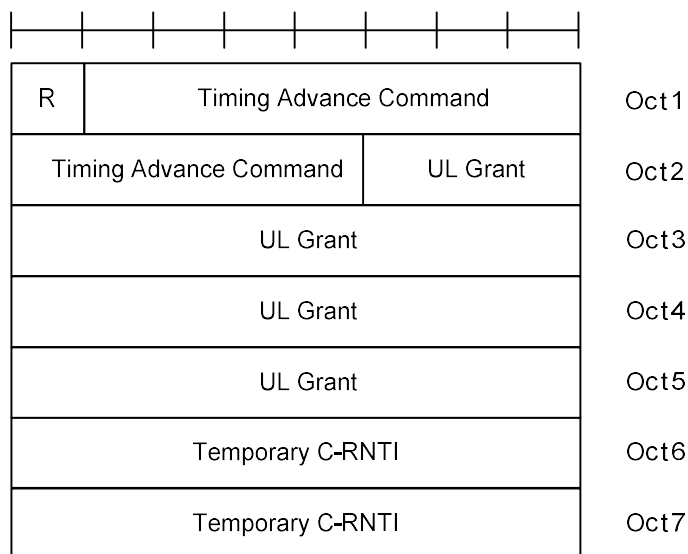

Figure 6.2.3-1: MAC RAR

7 Variables and constants

7.1 RNTI values

RNTI values are presented in Table 7.1-1.

Table 7.1-1: RNTI values.

Value (hexa-decimal)	RNTI
0000	N/A
0001–FFEF	RA-RNTI, Temporary C-RNTI, C-RNTI, MCS-C-RNTI, CS-RNTI, TPC-PUCCH-RNTI, TPC-PUSCH-RNTI, TPC-SRS-RNTI, INT-RNTI, SFI-RNTI, and SP-CSI-RNTI
FFF0–FFFD	Reserved
FFFE	P-RNTI
FFFF	SI-RNTI

Table 7.1-2: RNTI usage.

RNTI	Usage	Transport Channel	Logical Channel
P-RNTI	Paging and System Information change notification	PCH	PCCH
SI-RNTI	Broadcast of System Information	DL-SCH	BCCH
RA-RNTI	Random Access Response	DL-SCH	N/A
Temporary C-RNTI	Contention Resolution (when no valid C-RNTI is available)	DL-SCH	CCCH
Temporary C-RNTI	Msg3 transmission	UL-SCH	CCCH, DCCH, DTCH
C-RNTI, MCS-C-RNTI	Dynamically scheduled unicast transmission	UL-SCH	DCCH, DTCH
C-RNTI	Dynamically scheduled unicast transmission	DL-SCH	CCCH, DCCH, DTCH
MCS-C-RNTI	Dynamically scheduled unicast transmission	DL-SCH	DCCH, DTCH
C-RNTI	Triggering of PDCCH ordered random access	N/A	N/A
CS-RNTI	Configured scheduled unicast transmission (activation, reactivation and retransmission)	DL-SCH, UL-SCH	DCCH, DTCH
CS-RNTI	Configured scheduled unicast transmission (deactivation)	N/A	N/A
TPC-PUCCH-RNTI	PUCCH power control	N/A	N/A
TPC-PUSCH-RNTI	PUSCH power control	N/A	N/A
TPC-SRS-RNTI	SRS trigger and power control	N/A	N/A
INT-RNTI	Indication pre-emption in DL	N/A	N/A
SFI-RNTI	Slot Format Indication on the given cell	N/A	N/A
SP-CSI-RNTI	Activation of Semi-persistent CSI reporting on PUSCH	N/A	N/A
NOTE:	The usage of MCS-C-RNTI is equivalent to that of C-RNTI in MAC procedures (except for the C-RNTI MAC CE).		

7.2 Backoff Parameter values

Backoff Parameter values are presented in Table 7.2-1.

Table 7.2-1: Backoff Parameter values.

Index	Backoff Parameter value (ms)
0	5
1	10
2	20
3	30
4	40
5	60
6	80
7	120
8	160
9	240
10	320
11	480
12	960
13	1920
14	Reserved
15	Reserved

7.3 DELTA_PREAMBLE values

The DELTA_PREAMBLE preamble format based power offset values are presented in Tables 7.3-1 and 7.3-2.

Table 7.3-1: DELTA_PREAMBLE values for long preamble formats.

Preamble Format	DELTA_PREAMBLE values
0	0 dB
1	-3 dB
2	-6 dB
3	0 dB

Table 7.3-2: DELTA_PREAMBLE values for short preamble formats.

Preamble Format	DELTA_PREAMBLE values (dB)
A1	$8 + 3 \times \mu$
A2	$5 + 3 \times \mu$
A3	$3 + 3 \times \mu$
B1	$8 + 3 \times \mu$
B2	$5 + 3 \times \mu$
B3	$3 + 3 \times \mu$
B4	$3 \times \mu$
C0	$11 + 3 \times \mu$
C2	$5 + 3 \times \mu$

where μ is the sub-carrier spacing configuration determined by *msg1-SubcarrierSpacing* and Table 4.2-1 in TS 38.211 [8], and the preamble formats are given by *prach-ConfigurationIndex* and Tables 6.3.3.2-2 and 6.3.3.2-3 in TS 38.211 [8].

7.4 PRACH Mask Index values

Table 7.4-1: PRACH Mask Index values

PRACH Mask Index	Allowed PRACH occasion(s) of SSB
0	All
1	PRACH occasion index 1
2	PRACH occasion index 2
3	PRACH occasion index 3
4	PRACH occasion index 4
5	PRACH occasion index 5
6	PRACH occasion index 6
7	PRACH occasion index 7
8	PRACH occasion index 8
9	Every even PRACH occasion
10	Every odd PRACH occasion
11	Reserved
12	Reserved
13	Reserved
14	Reserved
15	Reserved

Annex A (informative): Change history

Change history							
Date	Meeting	TDoc	CR	Rev	Cat	Subject/Comment	New version
2017-04	RAN2#97bis	R2-1703006	-	-	-	Skeleton of NR MAC specification	0.0.1
2017-04	RAN2#97bis	R2-1703915	-	-	-	Editorial updates	0.0.2
2017-05	RAN2#98	R2-1704475	-	-	-	To capture agreements from RAN2#97bis	0.0.3
2017-06	RAN2 NR AH#2	R2-1706608	-	-	-	To capture agreements from RAN2#98	0.0.4
2017-06	RAN2 NR AH#2	R2-1707471	-	-	-	Endorsement of v0.0.4 (including minor updates)	0.1.0
2017-08	RAN2#99	R2-1707510	-	-	-	To capture agreements from RAN2 NR AH#2	0.2.0
2017-08	RAN2#99	R2-1709946	-	-	-	To capture agreements from RAN2#99	0.3.0
2017-09	RAN#77	RP-171733	-	-	-	To be presented to RAN for information	1.0.0
2017-11	RAN2#100	R2-1712698	-	-	-	To capture agreements from RAN2#99bis	1.1.0
2017-12	RAN2#100	R2-1714253	-	-	-	To capture agreements from RAN2#100	1.2.0
2017-12	RP-78	RP-172419	-	-	-	To be presented to RAN for approval	2.0.0
2017-12	RP-78					Upgraded to Rel-15	15.0.0
2018-03	RP-79	RP-180440	0039	1	F	General corrections on TS 38.321	15.1.0
2018-03	RP-79	RP-180440	0041	-	B	Introduction of MAC CEs for NR MIMO	15.1.0
2018-06	RP-80	RP-181216	0057	5	F	Miscellaneous corrections	15.2.0
	RP-80	RP-181216	0103	2	F	Addition of the beamFailureRecoveryTimer	15.2.0
	RP-80	RP-181214	0115	-	F	Correction to SR triggering to accommodate the configured grant	15.2.0
	RP-80	RP-181215	0145	1	F	Corrections on the timers in MAC	15.2.0
	RP-80	RP-181215	0148	1	F	Alternative 1 for Cross Carrier Indication for Semi-Persistent SRS MAC CE	15.2.0
	RP-80	RP-181215	0153	2	F	Flush HARQ buffer upon skipping a UL transmission	15.2.0
	RP-80	RP-181215	0166	1	F	Addition of Prioritized Random Access	15.2.0
	RP-80	RP-181216	0185	-	F	Introduction of PDCP duplication	15.2.0
	RP-80	RP-181216	0186	-	B	MAC CE adaptation for NR for TS 38.321	15.2.0
2018-09	RP-81	RP-181941	0058	5	F	Clarification on starting of drx-HARQ-RTT-TimerDL	15.3.0
	RP-81	RP-181939	0094	3	F	Correction of Configured Grant formula	15.3.0
	RP-81	RP-181940	0100	4	F	Introduction of DRX ambiguous period	15.3.0
	RP-81	RP-181938	0139	2	F	Clarification on timing requirement of SCell deactivation timer	15.3.0
	RP-81	RP-181938	0141	2	F	Correction on PUSCH resource handling for Semi-Persistent CSI reporting	15.3.0
	RP-81	RP-181940	0184	3	F	CR to 38.321 on the allocation of preambles for group B	15.3.0
	RP-81	RP-181940	0189	3	F	PRACH Preamble Selection for Msg1 based SI Request	15.3.0
	RP-81	RP-181938	0190	1	F	PRACH Resource Selection for RA Initiated by PDCCH Order	15.3.0
	RP-81	RP-181942	0193	4	F	Miscellaneous corrections	15.3.0
	RP-81	RP-181938	0200	1	F	Correction on BWP inactivity timer configuration	15.3.0
	RP-81	RP-181938	0203	2	F	Correction on Ci bitmap length determination in the Activation/Deactivation MAC CE	15.3.0
	RP-81	RP-181938	0206	2	F	Addition of NOTE to clarify meaning of available UL-SCH resource	15.3.0
	RP-81	RP-181939	0214	2	F	Correction to RO selection procedure	15.3.0
	RP-81	RP-181938	0215	2	F	CR on Semi-Persistent CSI Reporting and SRS for DRX	15.3.0
	RP-81	RP-181940	0234	2	F	Correction to CCCH LCID	15.3.0
	RP-81	RP-181938	0242	"	F	Correction to SP CSI reporting on PUCCH Activation and Deactivation MAC CE	15.3.0
	RP-81	RP-181938	0243	1	F	Correction to TCI State Indication for UE-specific PDCCH MAC CE	15.3.0
	RP-81	RP-181938	0245	1	F	CR on MAC RAR	15.3.0
	RP-81	RP-181939	0252	1	F	Correction for LCP restriction for duplication and non-duplication	15.3.0

	RP-81	RP-181939	0254	2	F	CR on BWP Inactivity timer	15.3.0
	RP-81	RP-181939	0255	2	F	Correction to BWP operations	15.3.0
	RP-81	RP-181938	0259	2	F	CR on BSR transmission with insufficient grant	15.3.0
	RP-81	RP-181940	0262	2	F	Corrections on Configured Grants and SPS	15.3.0
	RP-81	RP-181938	0272	2	F	CR on RA parameter description in TS 38.321	15.3.0
	RP-81	RP-181940	0275	1	F	Correction to acknowledgement for SPS deactivation	15.3.0
	RP-81	RP-181940	0276	1	F	Correction to handling of retransmission with a different TBS in DL HARQ	15.3.0
	RP-81	RP-181980	0279	2	F	Correction to BWP handling upon SCell deactivation	15.3.0
	RP-81	RP-181940	0280	2	F	Correction to MAC handling during different measurement gaps	15.3.0
	RP-81	RP-181939	0283	1	F	PDCCH for BFR termination	15.3.0
	RP-81	RP-181939	0285	!	F	CSI reporting in DRX	15.3.0
	RP-81	RP-181940	0290	1	F	Introduction of MCS-C-RNTI	15.3.0
	RP-81	RP-181941	0297	1	F	Clarification on the duration of timers in MAC	15.3.0
	RP-81	RP-181941	0300	1	F	Clarification on support of Type 2 PH	15.3.0
	RP-81	RP-181938	0302	-	F	PRACH Occasion Selection for Msg1 based SI Request	15.3.0
	RP-81	RP-181938	0304	-	F	Correction to RA Resource Selection Procedure	15.3.0
	RP-81	RP-181941	0306	2	F	Correction on BWP operation procedure	15.3.0
	RP-81	RP-181941	0326	2	F	CR on padding BSR	15.3.0
	RP-81	RP-181941	0328	1	F	CR on SR cancellation	15.3.0
	RP-81	RP-181941	0329	2	F	CR on BWP with ongoing RA procedure - Option 1	15.3.0
	RP-81	RP-181940	0331	1	F	CR on BWP inactivity timer stopping due to RA	15.3.0
	RP-81	RP-181941	0342	1	F	Correction for Random Access Back off	15.3.0
	RP-81	RP-181941	0356	1	F	RSRP measurements for Random Access	15.3.0
	RP-81	RP-181938	0357	1	F	Reset of BFD	15.3.0
	RP-81	RP-181942	0368	2	F	CR on first active BWP switching upon RRC (re)configuration	15.3.0
	RP-81	RP-181941	0371	1	F	Clarification on Long Truncated BSR	15.3.0
	RP-81	RP-181940	0376	-	F	Correction on SR with PUSCH resource handling of Semi-Persistent CSI reporting	15.3.0
	RP-81	RP-181940	0378	1	F	BWP operation for BFR RA	15.3.0
	RP-81	RP-181942	0402	2	F	Changes for MAC CEs to Support the Extended Maximum Number of TCI States	15.3.0