

EXHIBIT C – Infringement Claim Chart for U.S. Patent No. 11,192,568

The infringement claim chart below is meant to illustrate how the Accused Products (as identified in the cover document) include each and every limitation of claims 1 and 7-9 of U.S. Patent No. 11,192,568 (the “’568 Patent”). Each and every limitation of these claims of the ’568 Patent are literally present in the Accused Products. Baby Jogger does, however, reserve the right to contend that any claim limitation of the ’568 Patent found to be not literally present in the Accused Products is present under the doctrine of equivalents because each of the components of the Accused Products performs substantially the same function in substantially the same way to achieve substantially the same result as the limitations of the asserted claims of the ’568 Patent, and any alleged difference is insubstantial. Baby Jogger reserves the right to supplement and/or amend these claim charts or to assert new theories of infringement in light of the Court’s claim construction, based on any non-infringement positions asserted, and/or based on any discovery.

The infringement claim chart below cites representative examples of documents, videos, and visual representations to demonstrate how the Accused Products contain each and every limitation of claims 1 and 7-9 of the ’568 Patent. Baby Jogger reserves the right to rely on additional information to support its allegations of infringement, including, but not limited to, materials yet to be produced by UPPAbaby. Baby Jogger further notes that several of the images below have been annotated.

Baby Jogger reserves the right to rely on the entirety of the materials cited in this chart to demonstrate infringement of the Accused Products. Citations presented for one claim limitation are expressly incorporated by reference into all other limitations for that claim as well as all limitations of the claim(s) on which that claim depends.

U.S. Patent No. 11,192,568

[Ipre] A stroller, comprising:

Regardless of whether the preamble of claim 1 is considered a limitation, which Baby Jogger does not concede, the Accused Products are strollers. For example, the images below show a stroller.



<https://uppababy.com/accessories/strollers-accessories/vista-lower-adapter/>



<https://uppababy.com/accessories/strollers-accessories/rumbleseat-v2-plus/jake/>

[1a] a stroller frame comprising:

The Accused Products are strollers comprising a stroller frame. For example, the images below show a stroller frame.



<https://uppababy.com/accessories/strollers-accessories/vista-lower-adapter/>

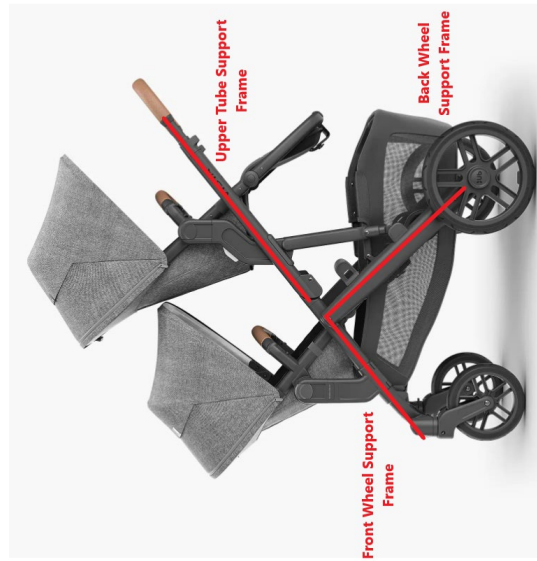

<https://uppababy.com/accessories/strollers-accessories/rumbleseat-v2-plus/jake/>

<p>[1b] a first upper tube support frame;</p>	<p>The Accused Products stroller frame has a first upper tube support frame and a second upper tube support frame. For example, the image below shows the first and second upper tube support frames.</p> <div data-bbox="240 594 695 940" data-label="Image"> <p>The image shows a top-down view of a stroller frame. Two red tubes are highlighted with red text labels. The label 'Second Upper Tube Support Frame' points to the front tube, and the label 'First Upper Tube Support Frame' points to the rear tube. The stroller has a grey seat and black wheels.</p> </div> <p>https://uppababy.com/strollers/full-size/vista-v2/greyson/</p>
<p>[1c] a second upper tube support frame;</p>	<p>See analysis for claim element [1b].</p>
<p>[1d] a first front wheel support frame rotatably adjusted to be substantially parallel with respect to the first upper tube support frame when the stroller frame is unfolded from a folded configuration;</p>	<p>The Accused Products stroller frame has a first front wheel support frame rotatably adjusted to be substantially parallel with respect to the first upper tube support frame when the stroller frame is unfolded from a folded configuration. The first front wheel support frame is located on the same side of the stroller frame as the first upper tube support frame. For example, the image below shows the stroller frame rotatably adjusted in an unfolded configuration such that the front wheel support frame is substantially parallel with respect to the first upper tube support frame. In the image below the first front wheel support frame and first upper tube support frame would be located on the opposite side of the stroller.</p>

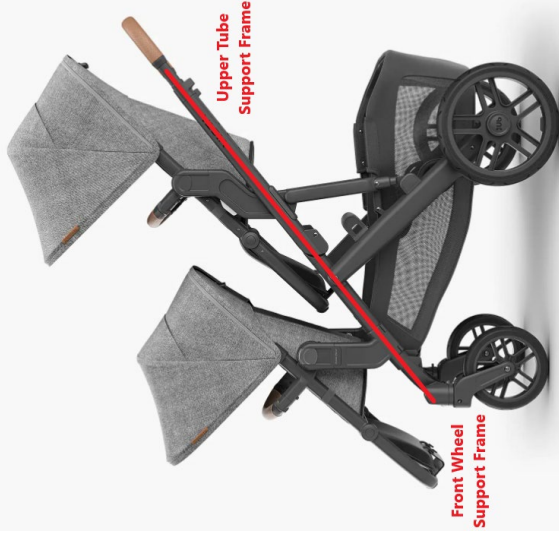

<https://uppababy.com/accessories/strollers-accessories/rumbleseat-v2-plus/jake/>

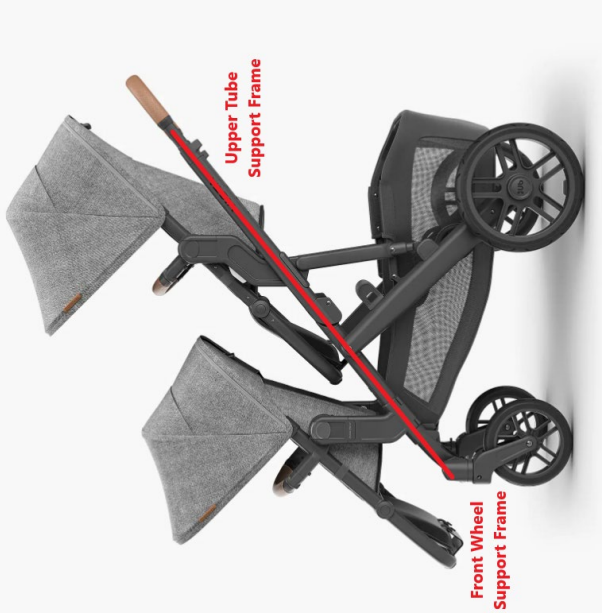

<https://uppababy.com/strollers/full-size/vista-v2/greyson/>

<p>The following videos further illustrate the Accused Products' folding mechanism and front wheel support frame rotatably adjusted to be substantially parallel with respect to the upper tube support frame when the stroller frame is unfolded from a folded configuration:</p> <ul style="list-style-type: none">• UPPAbaby Vista V2 – Fold + Unfold (https://www.youtube.com/watch?v=Vqv_IMezvii) (last accessed December 17, 2024);• UPPAbaby Vista V3 – Fold + Unfold (https://www.youtube.com/watch?v=uhDXXKw9rg8) (last accessed December 17, 2024);• UPPAbaby Vista Stroller – Fold + Store (https://www.youtube.com/watch?v=oaWvMrTDNvc) (last accessed December 17, 2024).	
<p>[1e] a second front wheel support frame rotatably adjusted to be substantially parallel with respect to the second upper tube support frame when the stroller frame is unfolded from a folded configuration; the second front wheel support frame is located on the same side of the stroller frame as the second upper tube support frame. For example, the image below shows the stroller frame rotatably adjusted in an unfolded configuration such that the front wheel support frame is substantially parallel with respect to the first upper tube support frame. In the image below the second front wheel support frame and second upper tube support frame would be located on the annotated side of the stroller.</p>  <p>https://uppababy.com/accessories/strollers-accessories/rumbleseat-v2-plus/jake/</p>	



<https://uppababy.com/strollers/full-size/vista-v2/greyson/>

The following videos further illustrate the Accused Products' folding mechanism and front wheel support frame rotatably adjusted to be substantially parallel with respect to the upper tube support frame when the stroller frame is unfolded from a folded configuration:

- UPPAbaby Vista V2 – Fold + Unfold (https://www.youtube.com/watch?v=Vqv_I梅zvil) (last accessed December 17, 2024);
- UPPAbaby Vista V3 – Fold + Unfold (<https://www.youtube.com/watch?v=uhDXZKw9rg8>) (last accessed December 17, 2024);
- UPPAbaby Vista Stroller – Fold + Store (<https://www.youtube.com/watch?v=oaWvMrTDNvc>) (last accessed December 17, 2024).

[11] a first back wheel support frame rotated with respect to the first upper tube support frame; and

The Accused Products have first and second back wheel support frames rotated with respect to the first and second upper tube support frames, respectively. For example, the images below show the upper tube support frame and back wheel support frames in a folded configuration and an unfolded configuration.



<https://uppababy.com/strollers/full-size/vista-v2/greyson/>

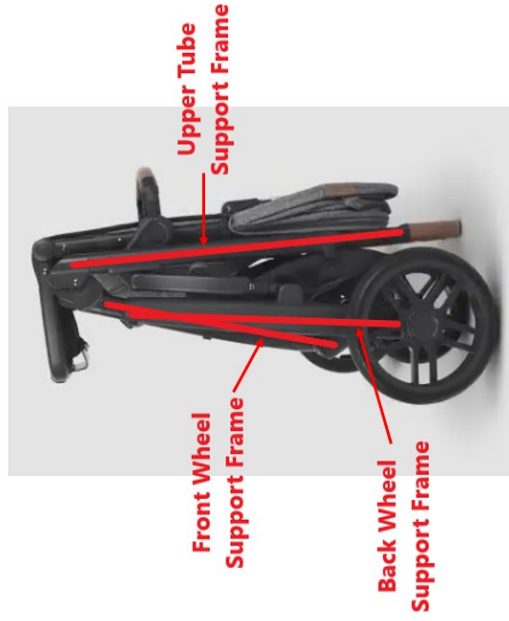

<https://uppababy.com/accessories/strollers-accessories/vista-lower-adapter/>

	<p>The following videos further illustrate the Accused Products’ folding mechanism and the first and second back wheel support frames rotated with respect to the first and second upper tube support frames:</p> <ul style="list-style-type: none"> • UPPAbaby Vista V2 – Fold + Unfold (https://www.youtube.com/watch?v=Vqv_IMezvii) (last accessed December 17, 2024); • UPPAbaby Vista V3 – Fold + Unfold (https://www.youtube.com/watch?v=uhDXZKw9rg8) (last accessed December 17, 2024); • UPPAbaby Vista Stroller – Fold + Store (https://www.youtube.com/watch?v=oaWvMrTDNvc) (last accessed December 17, 2024).
<p>[1g] a second back wheel support frame rotated with respect to the second upper tube support frame;</p>	<p>See analysis of claim element [1f].</p>
<p>[1h] a plurality of wheels comprising at least one front wheel and a plurality of back wheels;</p>	<p>The Accused Products comprise a plurality of wheels comprising at least one front wheel and a plurality of back wheels. For example, the images below show a stroller having two front wheels and two back wheels.</p>  <p>https://uppababy.com/accessories/strollers-accessories/vista-lower-adapter/</p>

	 <p>https://uppababy.com/accessories/strollers-accessories/rumbleseat-v2-plus/jake/</p>
<p>[ii] a first seat coupled along the first upper tube support frame and the second upper tube support frame at a first vertical position of the stroller frame;</p>	<p>The Accused Products comprise a first seat coupled along the first upper tube support frame and the second upper tube support frame at a first vertical position of the stroller frame. For example, the images below show a first seat coupled to the first and second upper tube support frames at a first vertical position.</p>



<https://uppababy.com/accessories/strollers-accessories/vista-lower-adapter/>

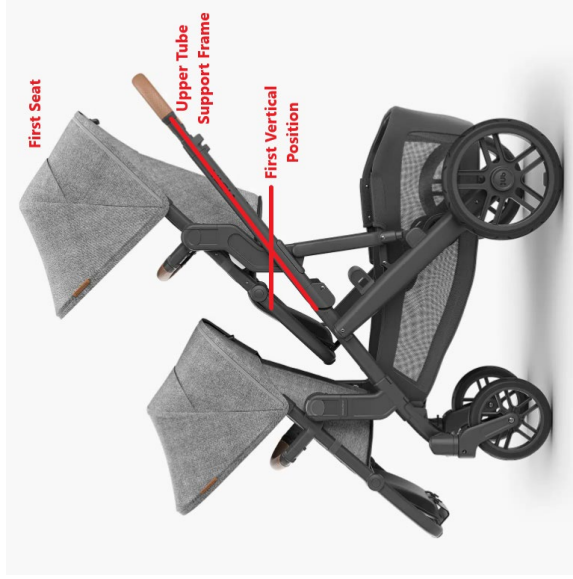

<https://uppababy.com/accessories/strollers-accessories/rumbleseat-v2-plus/jake/>

[1j] a first seat attachment adapter coupled to the first front wheel support frame at a second vertical position of the stroller frame that is below the first vertical position;

The Accused Products comprise a first seat attachment adapter coupled to the first front wheel support frame at a second vertical position of the stroller frame that is below the first vertical position. For example, the images below show a first seat attachment adapter coupled to the first front wheel support frame at a second vertical position. The second vertical position is below the first vertical position.

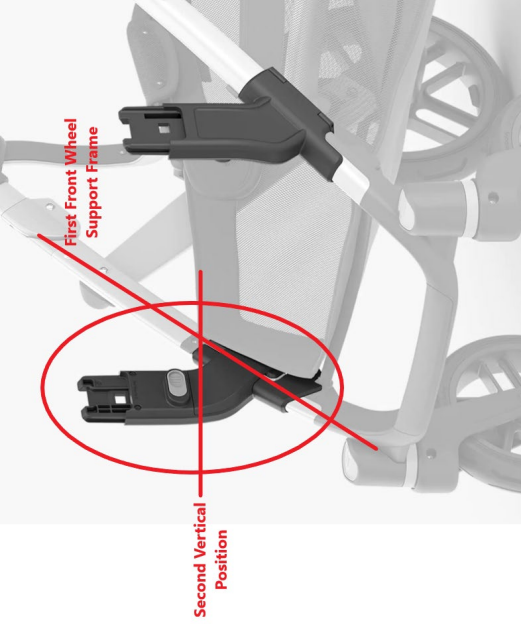

<https://uppababy.com/accessories/strollers-accessories/vista-lower-adapter/>

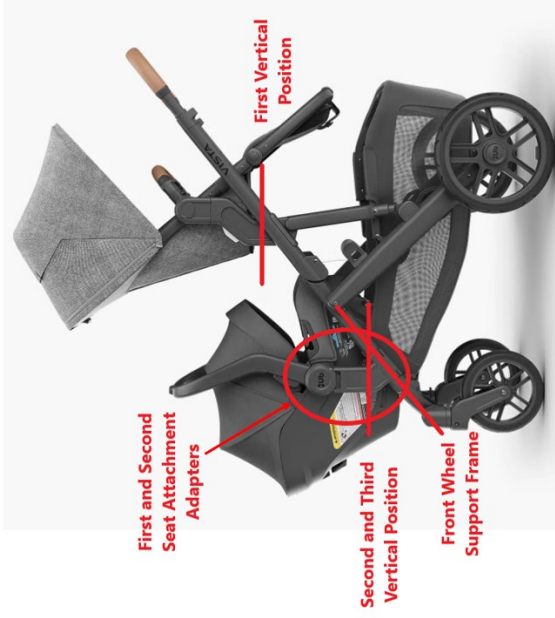

<https://uppababy.com/accessories/strollers-accessories/vista-lower-adapter/>

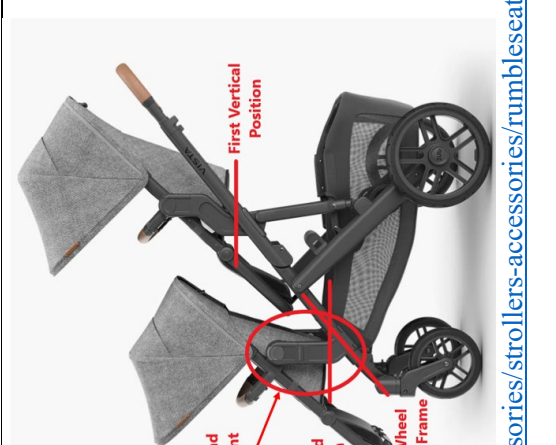
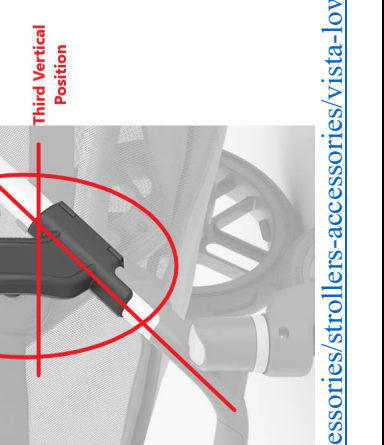
	 <p>https://uppababy.com/accessories/strollers-accessories/rumbleseat-v2-plus/jake/</p>
<p>[11k] a second seat attachment adapter coupled to the second front wheel support frame at a third vertical position of the stroller frame that is below the first vertical position;</p>	<p>The Accused Products comprise a second seat attachment adapter coupled to the second front wheel support frame at a third vertical position of the stroller frame that is below the first vertical position. For example, the images below show a second seat attachment adapter coupled to the second front wheel support frame at a third vertical position. The third vertical position is below the first vertical position.</p>
	 <p>https://uppababy.com/accessories/strollers-accessories/vista-lower-adapter/</p>

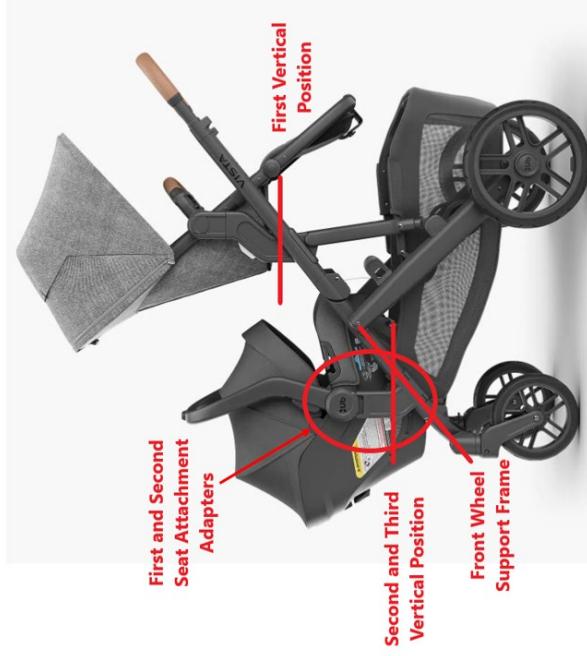

<https://uppababy.com/accessories/strollers-accessories/vista-lower-adapter/>

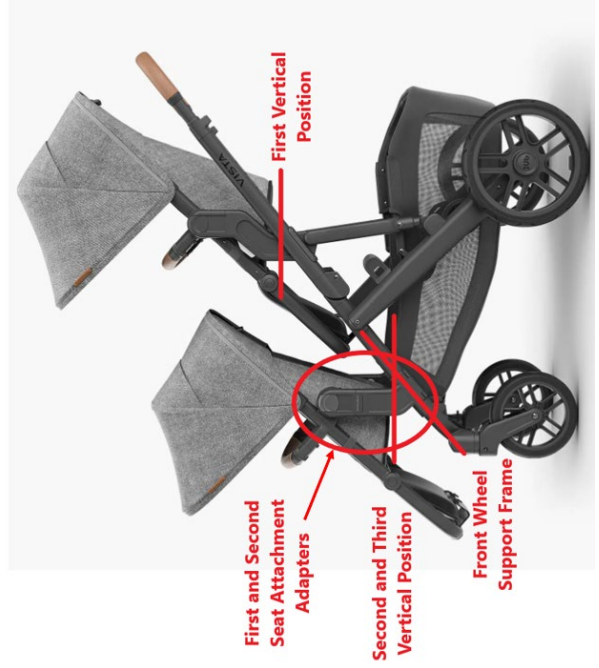

<https://uppababy.com/accessories/strollers-accessories/rumbleseat-v2-plus/jake/>

[III] wherein a second seat is removably coupled to the first seat attachment adapter and the second seat attachment adapter to position the second seat at a fourth vertical position and wherein the second vertical position and the third vertical position are at a same vertical height.

The Accused Products comprise a second seat that is removably coupled to the first seat attachment adapter and the second seat attachment adapter to position the second seat at a fourth vertical position that is below the first vertical position and wherein the second vertical position and the third vertical position are at a same vertical height. For example, the images below show the second seat removably coupled to the first and second seat attachment adapters at a fourth vertical position below the first vertical position. Further the images below show the second and third vertical positions at the same vertical height as each other.

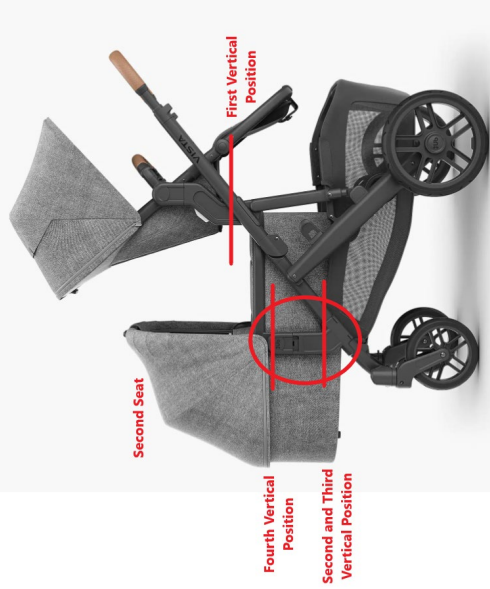

<https://uppababy.com/accessories/strollers-accessories/vista-lower-adapter/>

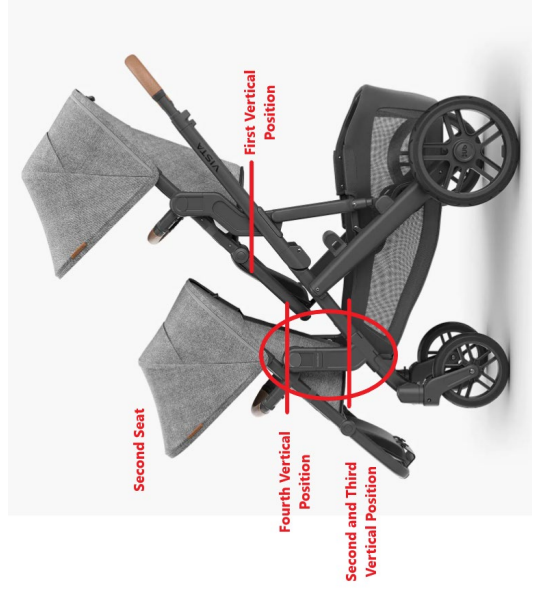

<https://uppababy.com/accessories/strollers-accessories/rumbleseat-v2-plus/jake/>

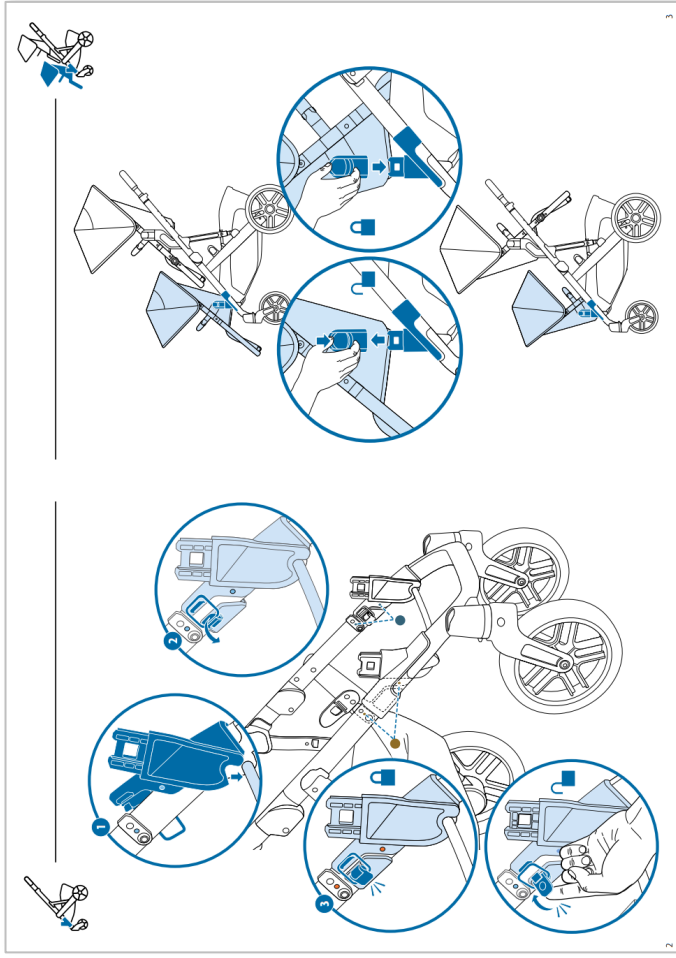

UPPAbaby RumbleSeat V2 Manual, at 2-3 (https://uppababy.com/wp-content/uploads/2023/12/0920-RBS_RumbleSeatV2Manual_010523.pdf)

The following videos further illustrate the Accused Products' second seat removably coupled to the first and second seat attachment adapters at a fourth vertical position below the first vertical position. The videos further show the second and third vertical positions at the same height.

- UPPAbaby Vista V3 – How-To Use in Double Mode (North America) (https://www.youtube.com/watch?v=DpGleTd_7LI&list=PPSV) (last accessed December 17, 2024);
- UPPAbaby Vista Stroller – Attaching the RumbleSeat Adapters (https://www.youtube.com/watch?v=QGSuC9d9k_Q&list=PPSV) (last accessed December 17, 2024);
- UPPAbaby Vista V2 Stroller (<https://www.youtube.com/watch?v=05j7t7hqWY4&list=PPSV>) (last accessed December 17, 2024);

- UPPAbaby Vista Stroller – Attaching the RumbleSeat Adapters + Lower Adapters (<https://www.youtube.com/watch?v=Tf5laA1JQKA&list=PPSV>) (last accessed December 17, 2024);
- UPPAbaby Vista Stroller – Infant + Toddler (<https://www.youtube.com/watch?v=g717b09f1os>) (last accessed December 17, 2024);
- UPPAbaby Vista Stroller – Twin Mode (<https://www.youtube.com/watch?v=VX8Ut21jVEQ>) (last accessed December 17, 2024);
- UPPAbaby Vista Stroller – Multiple Mode (<https://www.youtube.com/watch?v=c9HVuqMDvuo>) (last accessed December 17, 2024);
- UPPAbaby Vista Stroller – Toddler + Toddler (<https://www.youtube.com/watch?v=laDOKpoCY6k>) (last accessed December 17, 2024).

The Accused Products are strollers in which the first seat can be a baby seat, a car seat, a stroller seat, a bassinet, a baby carrier, or a pram and the second seat can likewise be baby seat, a car seat, a stroller seat, a bassinet, a baby carrier, or a pram. For example, the images below show examples of the various seat options for the first and second seats.

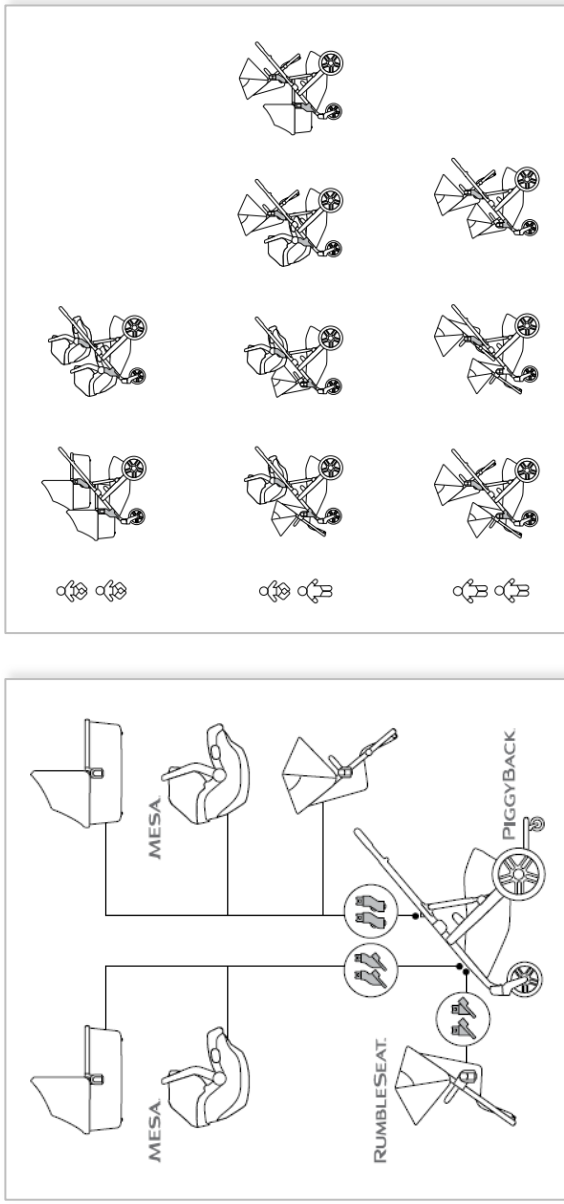

UPPAbaby Vista V2 Manual, at 44-45 (https://uppababy.com/wp-content/uploads/2023/09/VistaV2_Manual_230831.pdf); see also UPPAbaby Vista V3 Manual, at 22-23 (https://uppababy.com/wp-content/uploads/2024/09/0303-VSO_VistaV3ProductManual_2400819.pdf)

[8a] The stroller of claim 1, further comprising: a third seat attachment adapter coupled to the stroller frame at the first vertical position; and

The Accused Products are strollers comprising a third seat attachment adapter coupled to the stroller frame at the first vertical position. For example, the images below show the third seat attachment adapter coupled to the stroller frame at the first vertical position.

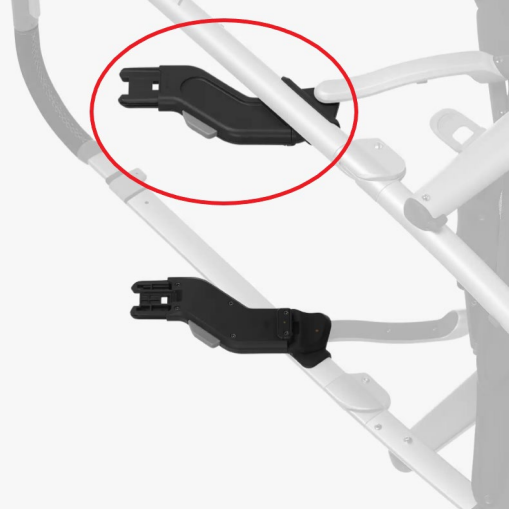

<https://uppbaby.com/accessories/strollers-accessories/vista-upper-adapter/>

The following videos further illustrate the Accused Products' third seat attachment adapter coupled to the stroller frame at the first vertical position:

- UPPAbaby Vista V3 – How-To Use in Double Mode (North America) (https://www.youtube.com/watch?v=DpGleTd_7Ll&list=PPSV) (last accessed December 17, 2024);
- UPPAbaby Vista Stroller – Attaching the RumbleSeat Adapters (https://www.youtube.com/watch?v=QGSuC9d9k_Q&list=PPSV) (last accessed December 17, 2024);
- UPPAbaby Vista V2 Stroller (<https://www.youtube.com/watch?v=05j7t7hqWY4&list=PPSV>) (last accessed December 17, 2024);
- UPPAbaby Vista Stroller – Attaching the RumbleSeat Adapters + Lower Adapters (<https://www.youtube.com/watch?v=Tf5IaA1JQKA&list=PPSV>) (last accessed December 17, 2024);
- UPPAbaby Vista Stroller – Infant + Toddler (<https://www.youtube.com/watch?v=g717b09f1os>) (last accessed December 17, 2024);

- UPPAbaby Vista Stroller – Twin Mode (<https://www.youtube.com/watch?v=VX8Ur21jVEQ>) (last accessed December 17, 2024);
- UPPAbaby Vista Stroller – Multiple Mode (<https://www.youtube.com/watch?v=c9HVuqMDvuo>) (last accessed December 17, 2024);
- UPPAbaby Vista Stroller – Toddler + Toddler (<https://www.youtube.com/watch?v=laDOKpoCY6k>) (last accessed December 17, 2024).

The Accused Products are strollers comprising a fourth seat attachment adapter coupled to the stroller frame at the first vertical position. For example, the images below show the fourth seat attachment adapter coupled to the stroller frame at the first vertical position.

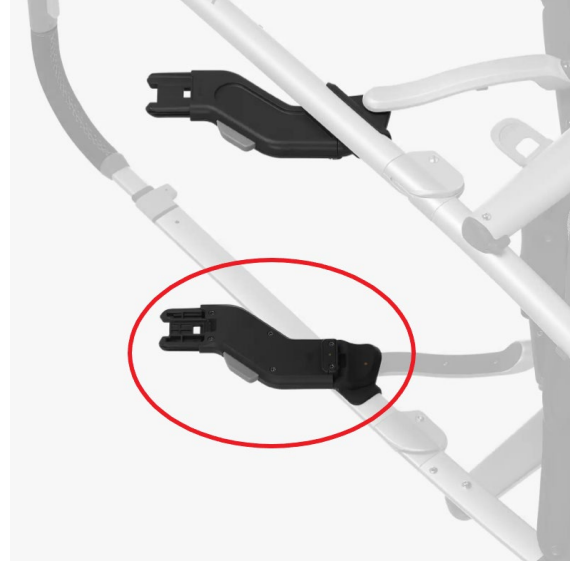

<https://uppababy.com/accessories/strollers-accessories/vista-upper-adapter/>

The following videos further illustrate the Accused Products' fourth seat attachment adapter coupled to the stroller frame at the first vertical position:

- UPPAbaby Vista V3 – How-To Use in Double Mode (North America) (https://www.youtube.com/watch?v=DpGleTd_7LJ&list=PPSV) (last accessed December 17, 2024);
- UPPAbaby Vista Stroller – Attaching the RumbleSeat Adapters (https://www.youtube.com/watch?v=QGSuC9d9k_Q&list=PPSV) (last accessed December 17, 2024);

- UPPAbaby Vista V2 Stroller (<https://www.youtube.com/watch?v=05j7t7hqWY4&list=PPSV>) (last accessed December 17, 2024);
- UPPAbaby Vista Stroller – Attaching the RumbleSeat Adapters + Lower Adapters (<https://www.youtube.com/watch?v=Tf5IaA1JQKA&list=PPSV>) (last accessed December 17, 2024);
- UPPAbaby Vista Stroller – Infant + Toddler (<https://www.youtube.com/watch?v=g717b09f1os>) (last accessed December 17, 2024);
- UPPAbaby Vista Stroller – Twin Mode (<https://www.youtube.com/watch?v=VX8Ut21jVEQ>) (last accessed December 17, 2024);
- UPPAbaby Vista Stroller – Multiple Mode (<https://www.youtube.com/watch?v=c9HVuqMDvuo>) (last accessed December 17, 2024);
- UPPAbaby Vista Stroller – Toddler + Toddler (<https://www.youtube.com/watch?v=laDOKpoCY6k>) (last accessed December 17, 2024).

[8c] wherein the first seat is removably coupled to the third seat attachment adapter and the fourth seat attachment adapter.

The Accused Products are strollers in which the first seat is removably coupled to the third seat attachment adapter and the fourth seat attachment adapter. For example, the images below show the first seat removably coupled to the third and fourth seat attachment adapters.

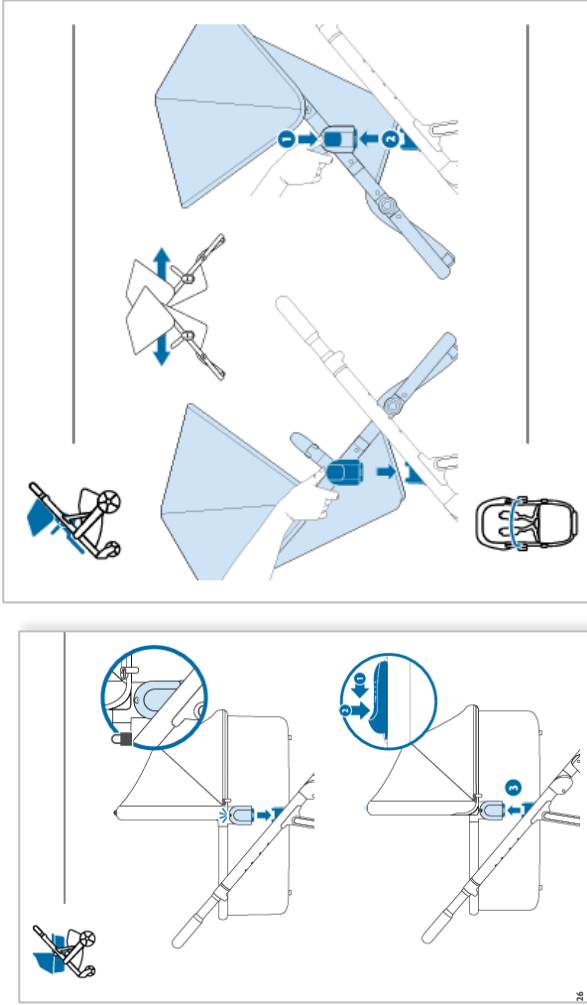

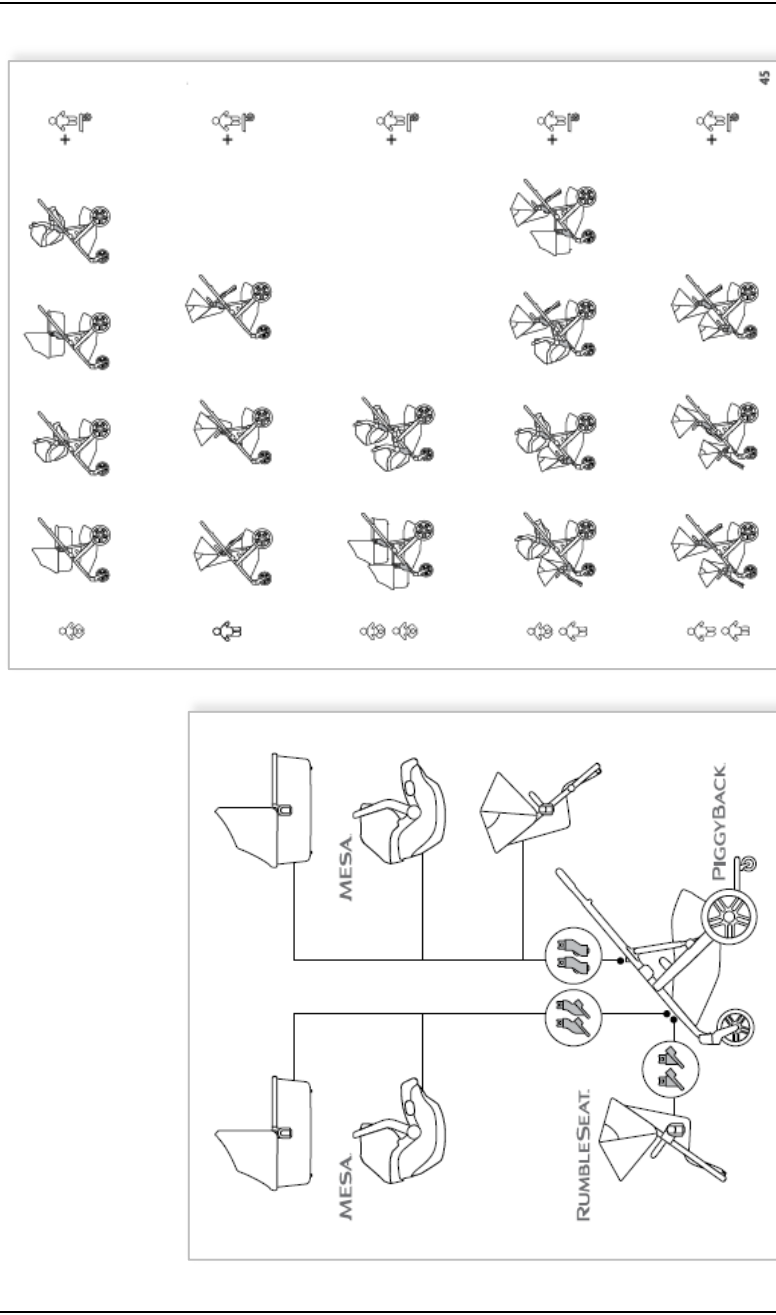

UPPAbaby Vista V2 Manual, at 26, 28, 44-45 (https://uppababy.com/wp-content/uploads/2023/09/VistaV2_Manual_230831.pdf); see also UPPAbaby Vista V3 Manual, at 6, 22-23 (https://uppababy.com/wp-content/uploads/2024/09/0303-VSO_VistaV3ProductManual_2400819.pdf)

The following videos further illustrate the Accused Products' first seat removably coupled to the third and fourth seat attachment adapters:

- UPPAbaby Vista V3 – How-To Use in Double Mode (North America) (https://www.youtube.com/watch?v=DpGfLeTd_7LI&list=PPSV) (last accessed December 17, 2024);
- UPPAbaby Vista Stroller – Attaching the RumbleSeat Adapters (https://www.youtube.com/watch?v=QGSuC9d9k_Q&list=PPSV) (last accessed December 17, 2024);
- UPPAbaby Vista V2 Stroller (<https://www.youtube.com/watch?v=05j7t7hqWY4&list=PPSV>) (last accessed December 17, 2024);

<ul style="list-style-type: none"> • UPPAbaby Vista Stroller – Attaching the RumbleSeat Adapters + Lower Adapters (https://www.youtube.com/watch?v=Tf5laA1JQKA&list=PPSV) (last accessed December 17, 2024); • UPPAbaby Vista Stroller – Infant + Toddler (https://www.youtube.com/watch?v=g717b09f1os) (last accessed December 17, 2024); • UPPAbaby Vista Stroller – Twin Mode (https://www.youtube.com/watch?v=VX8Ut21jVEQ) (last accessed December 17, 2024); • UPPAbaby Vista Stroller – Multiple Mode (https://www.youtube.com/watch?v=c9HVuqMDvuo) (last accessed December 17, 2024); • UPPAbaby Vista Stroller – Toddler + Toddler (https://www.youtube.com/watch?v=laDOKpoCY6k) (last accessed December 17, 2024). 	
<p>The Accused Products are strollers comprising a handle comprising a first end coupled to the first upper tube support frame and a distal second end coupled to the second upper tube support frame. For example, the images below show a handle having a first end couple to the first upper tube support frame and a distal second end coupled to the second upper tube support frame.</p>  <p>https://uppababy.com/strollers/full-size/vista-v2/greyson/</p>	<p>[9] The stroller of claim 1, further comprising a handle comprising a first end coupled to the first upper tube support frame and a distal second end coupled to the second upper tube support frame.</p>