

# Fleet Hoster FleetFlix Lite Pro+

## Infringement where the diversity antenna is considered the first antenna

\* The photos used for the **Fleet Hoster FleetFlix Lite Pro+** correspond to the **Streamax C6 Lite Dual Lens**, since both devices have the same architecture and same antenna geometries.

**CONFIDENTIAL**

# US 11,349,200 - Fleet Hoster FleetFlix Lite Pro+

## Claim 6

[6-preamble] A wireless device comprising

[6-preamble]  
Wireless device



CONFIDENTIAL

# US 11,349,200 - Fleet Hoster FleetFlix Lite Pro+

## Claim 6

[6a] an antenna system comprising  
[6b] a ground plane and  
[6c] at least two antennas within the wireless device, the antenna system comprising:

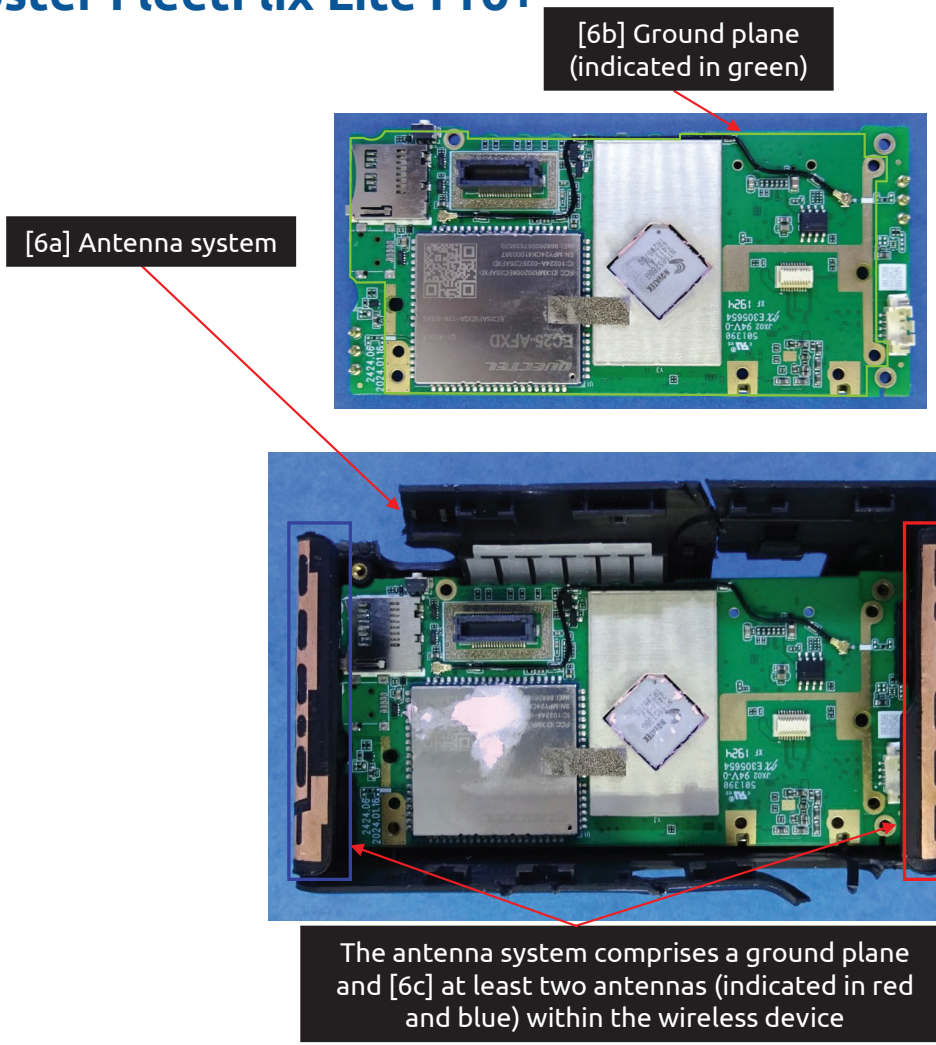

CONFIDENTIAL

# US 11,349,200 - Fleet Hoster FleetFlix Lite Pro+

## Claim 6

[6d] a first antenna configured to provide operation in at least four frequency bands being used by 4G communication standards, wherein

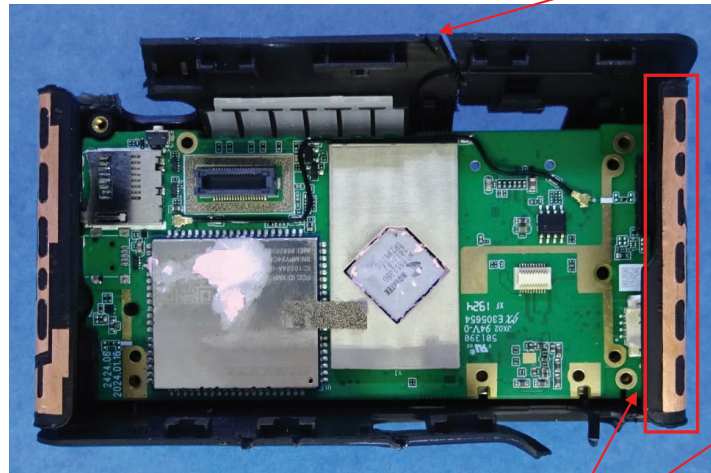

Antenna system

[6d] The antenna system comprises a first antenna (indicated in red) configured to provide operation in at least LTE 700(B12)/850(B5)/2100(B4)/1900(B2)

LTE Cat 4	EC25-AFXD (Data-only)
Region/Operator	North America
Dimensions (mm)	29.0 × 32.0 × 2.4
Temperature Ranges	
Operating Temperature	-35 °C to +75 °C
Extended Temperature	-40 °C to +85 °C
Frequency Bands	
LTE-FDD	B2/4/5/12/13/14/66/71
LTE-TDD	-
WCDMA	B2/4/5
GSM/EDGE	-
GNSS (Optional)	GPS/GLONASS/BDS/Galileo/QZSS

Source: Quectel EC25 Series

CONFIDENTIAL

# US 11,349,200 - Fleet Hoster FleetFlix Lite Pro+

## Claim 6

[6e] at least two of the at least four frequency bands are contained within a first frequency range and  
 [6f] at least two of the at least four frequency bands are contained within a second frequency range,  
 [6g] the first frequency range being lower in frequency than the second frequency range,

[6e] At least two of the at least four frequency bands are contained within a first frequency range (filled in red) and  
 [6f] at least two of the at least four frequency bands are contained within a second frequency range (filled in blue)

LTE Cat 4	EC25-AFXD (Data-only)
Region/Operator	North America
Dimensions (mm)	29.0 × 32.0 × 2.4
Temperature Ranges	
Operating Temperature	-35 °C to +75 °C
Extended Temperature	-40 °C to +85 °C
Frequency Bands	
LTE-FDD	B2/4/5/13/13/14/66/71
LTE-TDD	-
WCDMA	B2/A/5
GSM/EDGE	-
GNSS (Optional)	GPS/GLONASS/BDS/Galileo/QZSS

Source: Quectel EC25 Series

[6g] The first frequency range being lower in frequency than the second frequency range

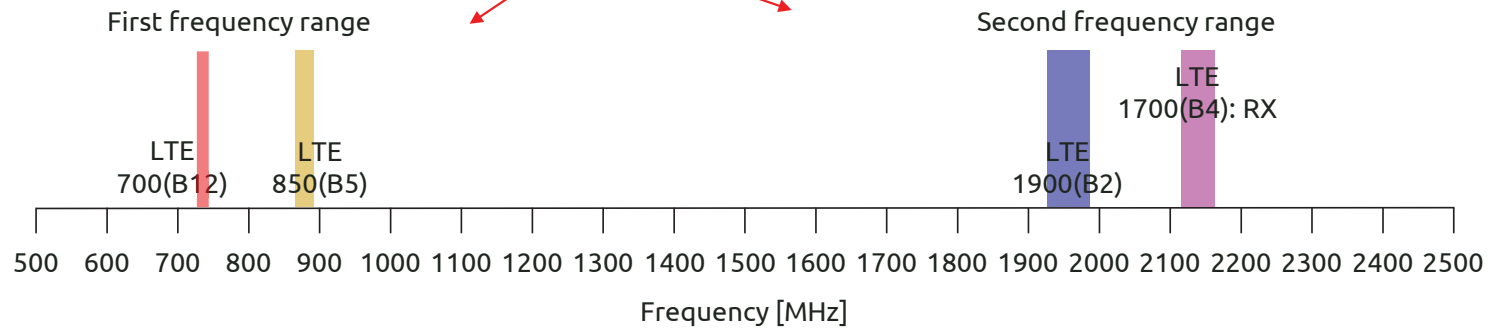

CONFIDENTIAL

# US 11,349,200 - Fleet Hoster FleetFlix Lite Pro+

## Claim 6

[6h] the first antenna defining a first antenna contour comprising an entire perimeter of the first antenna, and

[6h] The first antenna defines a first antenna contour (indicated in blue and red) comprising an entire perimeter of the first antenna

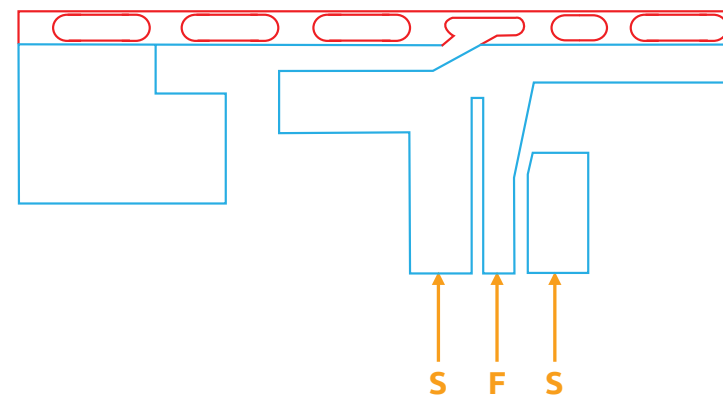
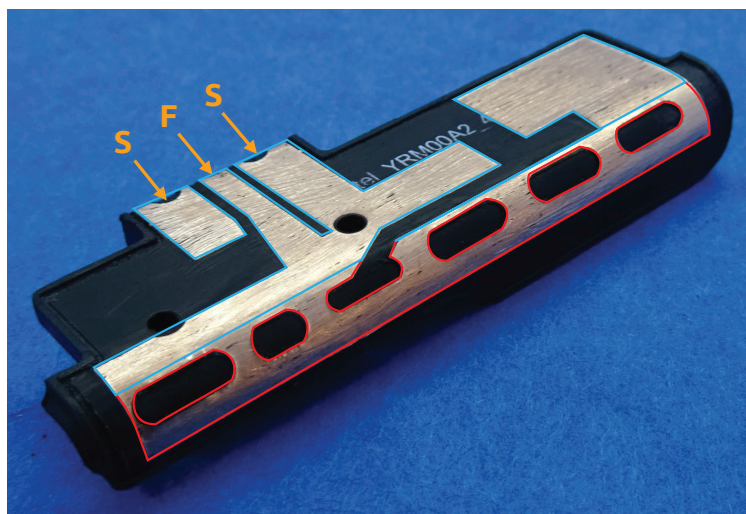

CONFIDENTIAL

# US 11,349,200 - Fleet Hoster FleetFlix Lite Pro+

## Claim 6

[6i] wherein the first antenna contour has a level of complexity defined by complexity factor  $F_{21}$  having a value of at least 1.20 and

[6i] The first antenna contour has a level of complexity defined by complexity factor  $F_{21}$  having a value of at least 1.20

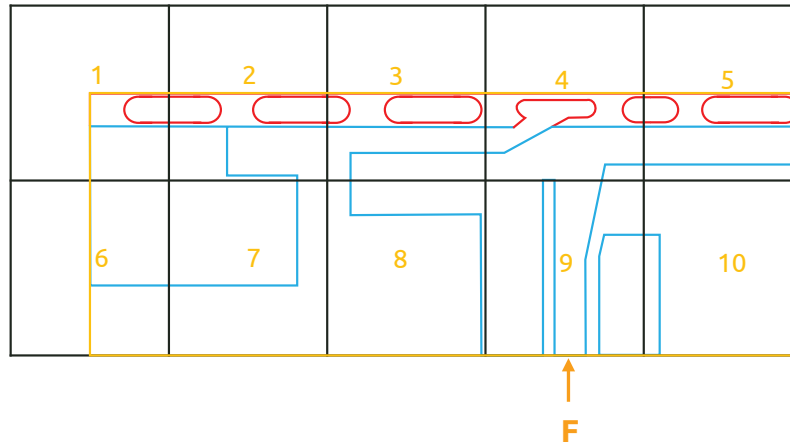

$N_1 = 10$  cells

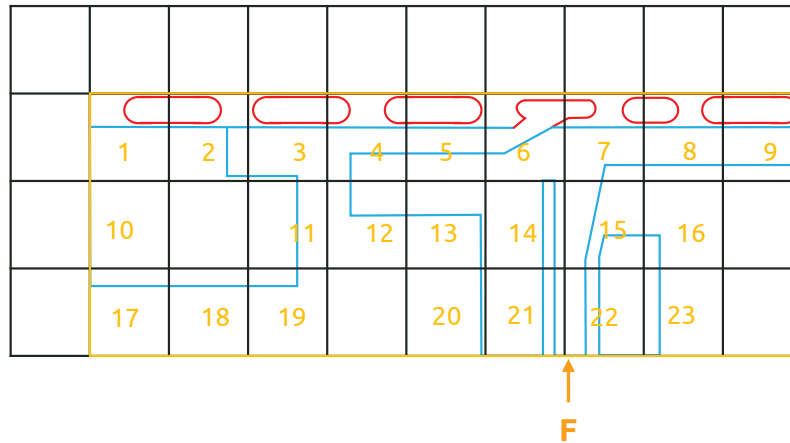

$N_2 = 23$  cells

$$F_{21} = -\frac{\log(N_2) - \log(N_1)}{\log\left(\frac{1}{2}\right)} = \frac{\log(23/10)}{\log(2)} = 1.201 \geq 1.20$$

CONFIDENTIAL

# US 11,349,200 - Fleet Hoster FleetFlix Lite Pro+

## Claim 6

[6j] complexity factor  $F_{32}$  having a value of at least 1.35; and

[6j] The first antenna contour has a level of complexity defined by complexity factor  $F_{32}$  having a value of at least 1.35

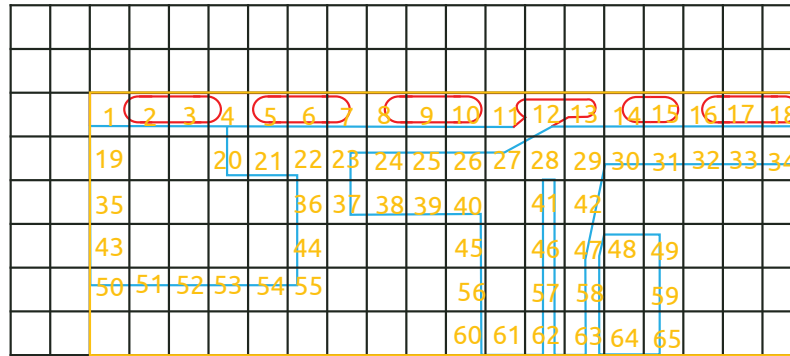

$N_3 = 65 \text{ cells}$

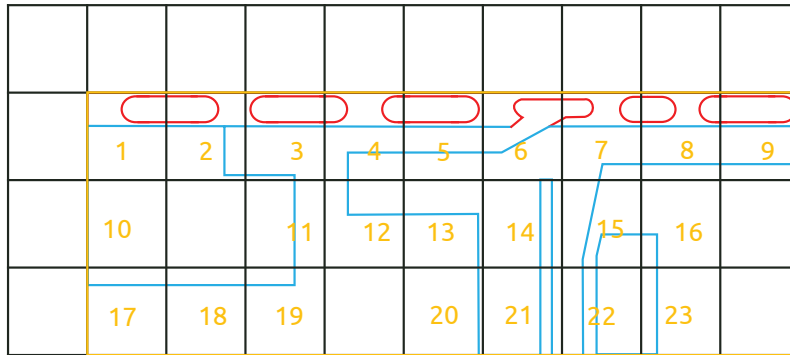

$N_2 = 23 \text{ cells}$

$$F_{32} = -\frac{\log(N_3) - \log(N_2)}{\log\left(\frac{1}{2}\right)} = \frac{\log(65/23)}{\log(2)} = 1.50 \geq 1.35$$

CONFIDENTIAL

# US 11,349,200 - Fleet Hoster FleetFlix Lite Pro+

## Claim 6

[6k] a second antenna configured to operate in at least one frequency band being used by a 4G communication standard,

Antenna system

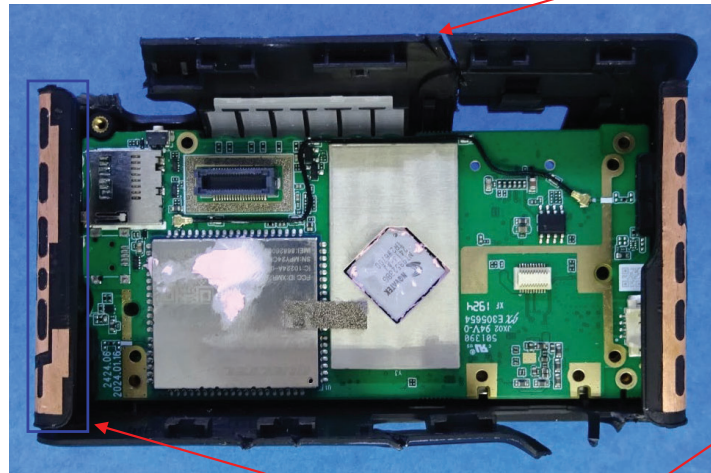

[6k] The antenna system comprises a second antenna (indicated in blue) configured to operate in at least LTE 700(B12)

LTE Cat 4	EC25-AFXD (Data-only)
Region/Operator	North America
Dimensions (mm)	29.0 × 32.0 × 2.4
Temperature Ranges	
Operating Temperature	-35 °C to +75 °C
Extended Temperature	-40 °C to +85 °C
Frequency Bands	
LTE-FDD	B2/4/5/12/13/14/66/71
LTE-TDD	-
WCDMA	B2/4/5
GSM/EDGE	-
GNSS (Optional)	GPS/GLONASS/BDS/Galileo/QZSS

Source: Quectel EC25 Series

CONFIDENTIAL

## US 11,349,200 - Fleet Hoster FleetFlix Lite Pro+

### Claim 6

[6l] the second antenna defining an antenna box that is a minimum-sized parallelepiped that completely encloses a volume of the second antenna and [6m] wherein each face of the minimum-sized parallelepiped is tangent to at least one point of the volume of the second antenna,

[6l] The second antenna defines an antenna box (outlined in pink) that is a minimum-sized parallelepiped that completely encloses a volume of the second antenna

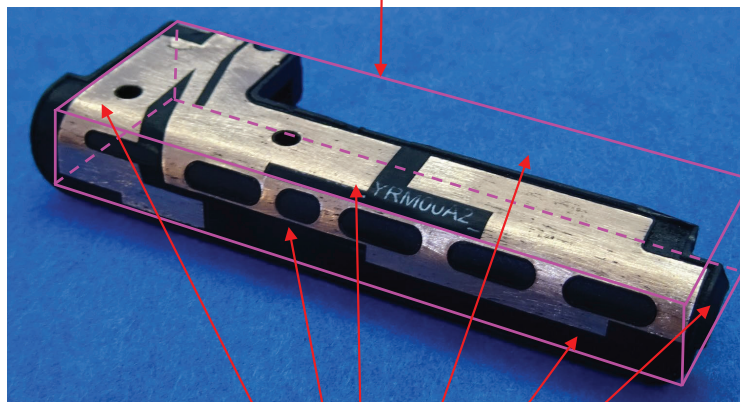

[6m] Each face of the minimum-sized parallelepiped is tangent to at least one point of the volume of the second antenna

CONFIDENTIAL

## US 11,349,200 - Fleet Hoster FleetFlix Lite Pro+

### Claim 6

[6n] an orthogonal projection of the antenna box along a normal to a face with a largest area of the second antenna defining [6o] an antenna rectangle,

[6o] Antenna rectangle (filled in green)

[6n] An orthogonal projection of the antenna box along a normal to a face\* with a largest area of the second antenna

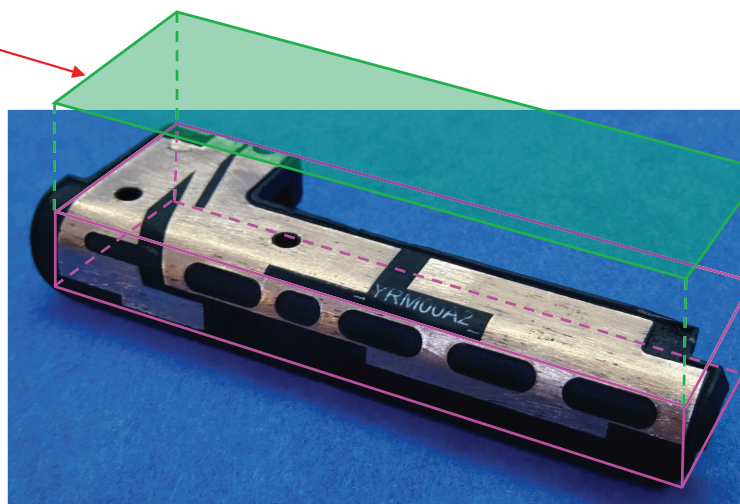

\*Normal to a face means perpendicular to the face

**CONFIDENTIAL**

## US 11,349,200 - Fleet Hoster FleetFlix Lite Pro+

### Claim 6

[6p] an aspect ratio of the antenna rectangle being defined as a ratio between a width and a height of the antenna rectangle, and wherein the aspect ratio has a value of at least 2, and

[6p] Aspect ratio of the antenna rectangle being defined as a ratio between a width and a height of the antenna rectangle, and wherein the aspect ratio has a value of  $53.5/18.9 = 2.83 \geq 2$

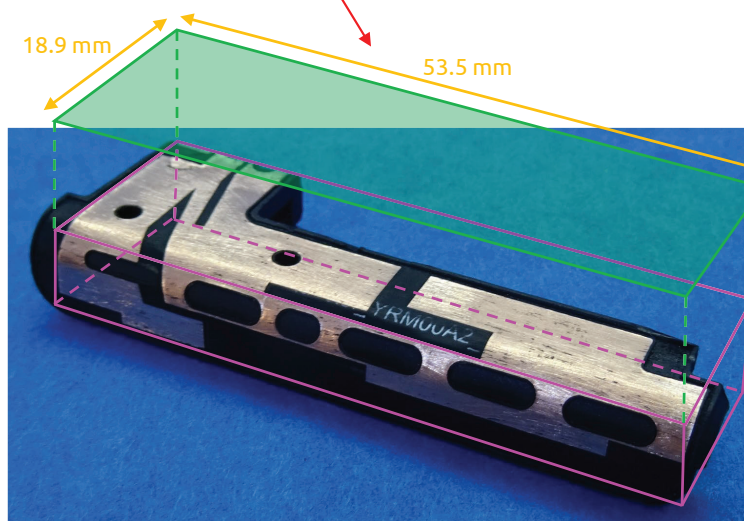

CONFIDENTIAL

# US 11,349,200 - Fleet Hoster FleetFlix Lite Pro+

## Claim 6

[6q] wherein at least one of the first and second antennas is close to a first short side of a ground plane rectangle enclosing the ground plane.

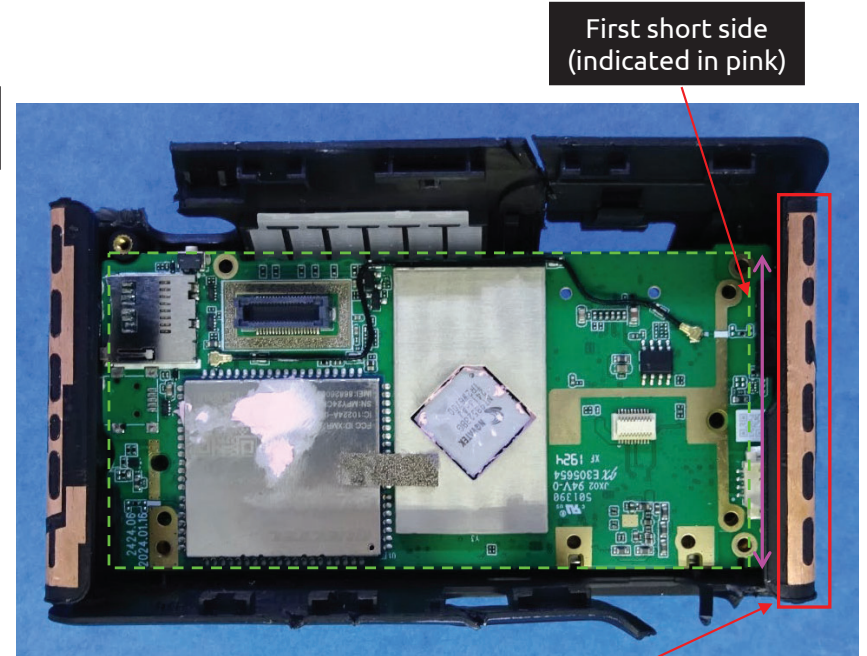
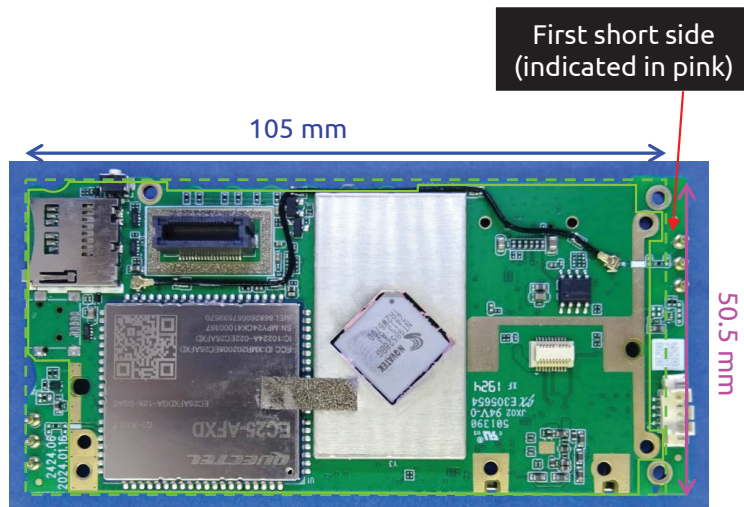

[6q] At least the first antenna is close to a first short side of a ground plane rectangle (indicated with a dashed green line) enclosing the ground plane

CONFIDENTIAL

# US 11,349,200 - Fleet Hoster FleetFlix Lite Pro+

## Claim 7

[7a] The wireless device of claim 6, wherein the first antenna contour comprises at least 20 segments.

[7a] The first antenna contour (indicated in blue and red) comprises at least 20 segments

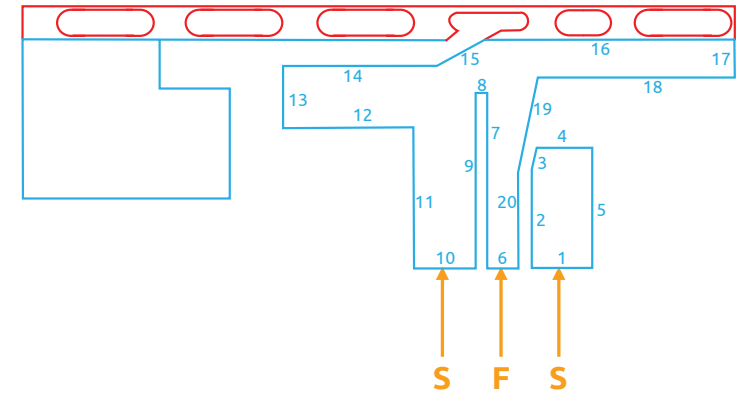
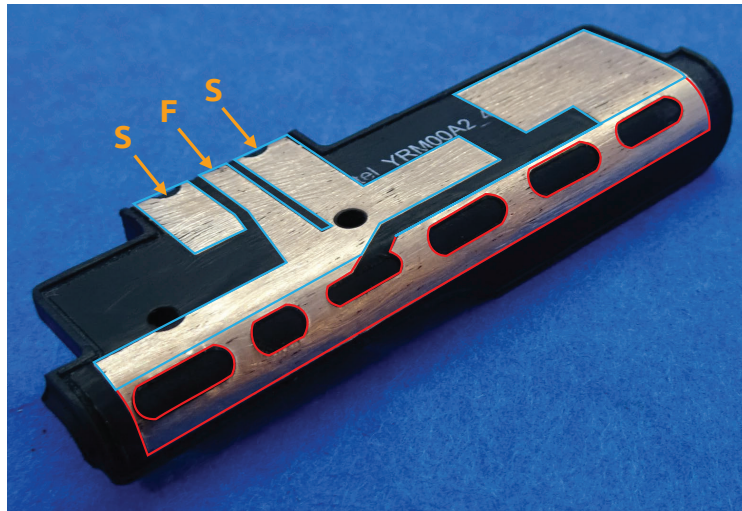

CONFIDENTIAL

# US 11,349,200 - Fleet Hoster FleetFlix Lite Pro+

## Claim 9

[9a] The wireless device of claim 6, wherein the second antenna defines a second antenna contour comprising an entire perimeter of the second antenna,

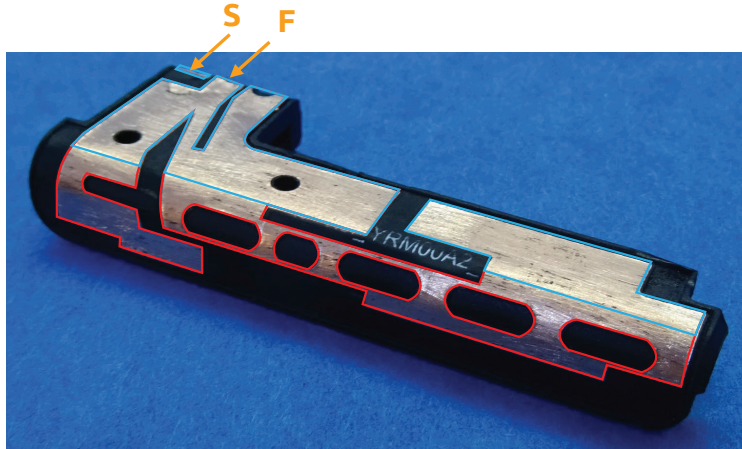

[9a] The second antenna defines a second antenna contour (indicated in blue and red) comprising an entire perimeter of the second antenna

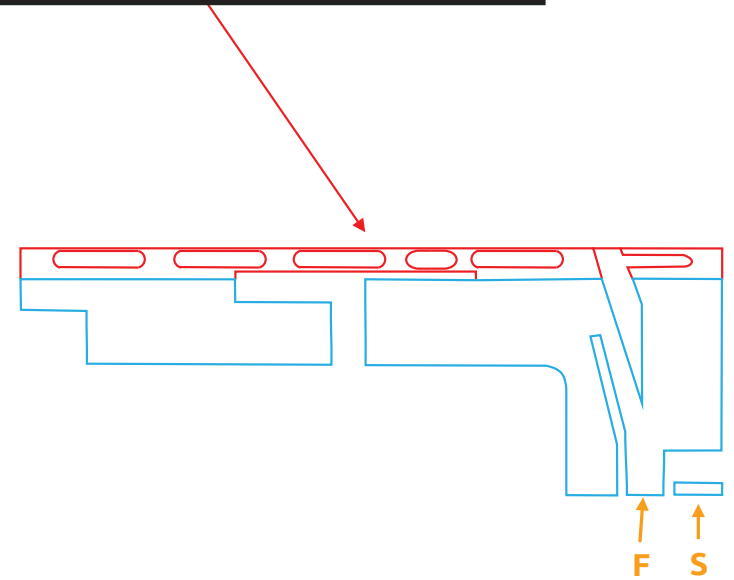

CONFIDENTIAL

# US 11,349,200 - Fleet Hoster FleetFlix Lite Pro+

## Claim 9

[9b] wherein a length of the second antenna contour is greater than four times a diagonal of the antenna rectangle.

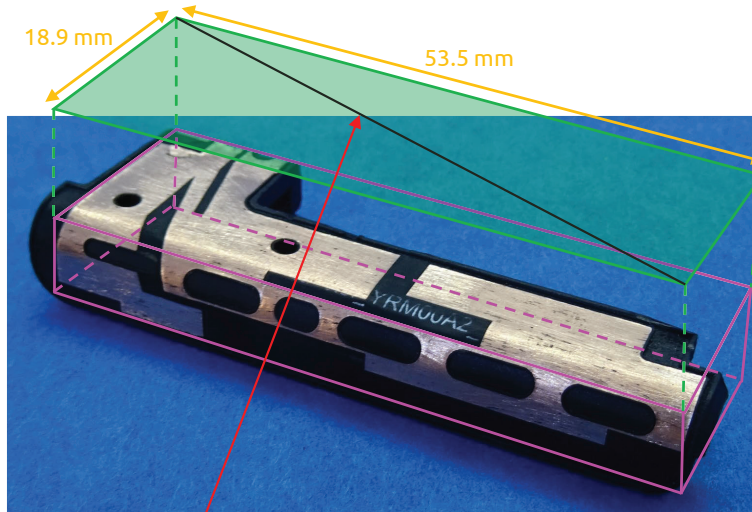

Diagonal of the antenna rectangle = 56.74 mm

[9b] The length of the second antenna contour (362.8 mm) > 4\*Diagonal of the antenna rectangle (4\*56.74 = 226.96 mm)

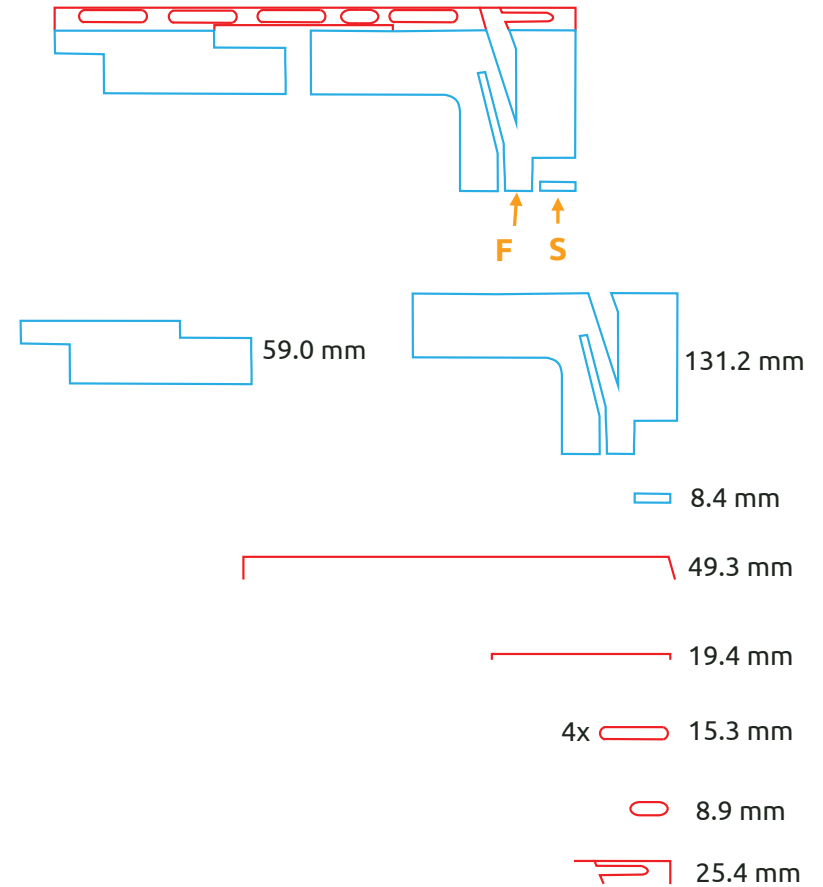

Length of the second antenna contour =  
 $(59.0 + 131.2 + 8.4 + 49.3 + 19.4 + 4*15.3 + 8.9 + 25.4) = 362.8 \text{ mm}$

**CONFIDENTIAL**

# US 11,349,200 - Fleet Hoster FleetFlix Lite Pro+

## Claim 10

[10a] The wireless device of claim 6, wherein the antenna system comprises a third antenna configured to provide operation in a wireless communication standard.

[10a] The antenna system comprises a third antenna (indicated in yellow) configured to provide operation in at least a wireless communication standard: WiFi

### 4.2 General Description of EUT

Product Name:	Camera
Mode No.:	AD Plus2.0/AD Lite,C6 Lite
Test Model No.:	AD Plus2.0
Trade mark:	STREAMAX
EUT Supports Radios	2.4GHz Wi-Fi:

Source: FCC test report

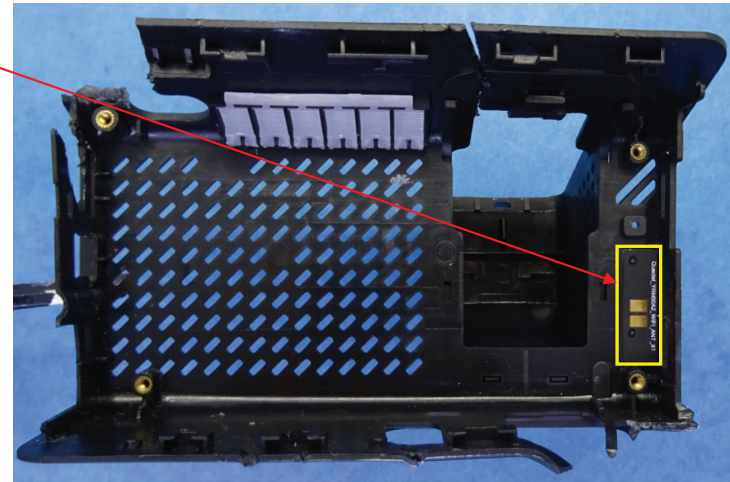

CONFIDENTIAL

## US 11,349,200 - Fleet Hoster FleetFlix Lite Pro+

### Claim 11

[11-preamble] A wireless device comprising:

[11-preamble]  
Wireless device



**CONFIDENTIAL**

# US 11,349,200 - Fleet Hoster FleetFlix Lite Pro+

## Claim 11

[11a] an antenna system comprising  
[11b] a ground plane and  
and  
[11c] at least two antennas within the wireless device, the antenna system comprising:

[11b] Ground plane  
(indicated in green)

[11a] Antenna system

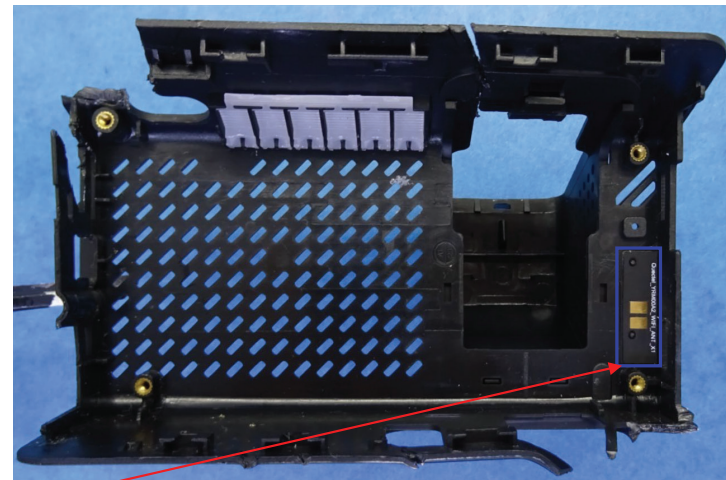
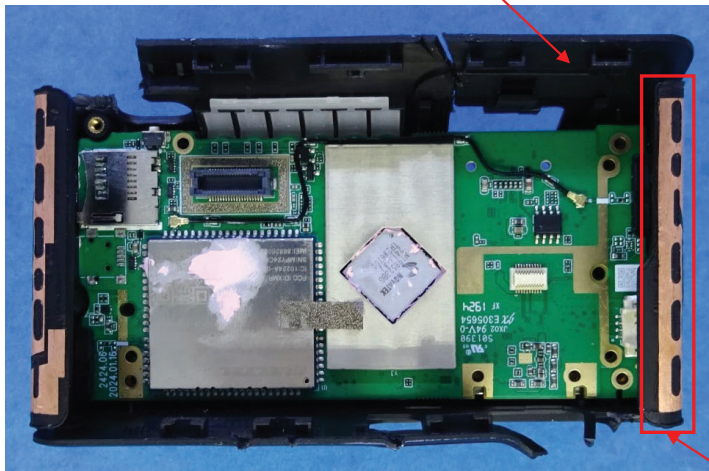
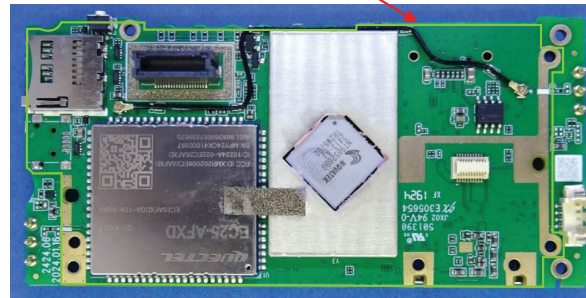

The antenna system comprises a ground plane and [11c] at least two antennas (indicated in red and blue) within the wireless device

**CONFIDENTIAL**

# US 11,349,200 - Fleet Hoster FleetFlix Lite Pro+

## Claim 11

[11d] a first antenna configured to provide operation in at least three frequency bands being used by 4G communication standards,

Antenna system

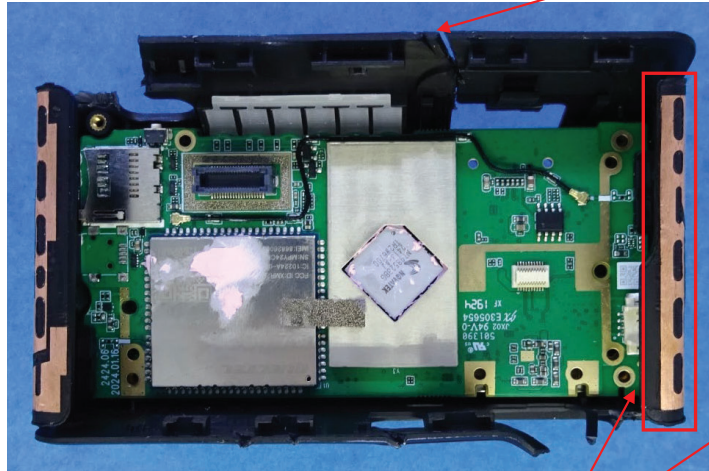

[11d] The antenna system comprises a first antenna (indicated in red) configured to provide operation in at least LTE 700(B12)/2100(B4)/1900(B2)

LTE Cat 4	EC25-AFXD (Data-only)
Region/Operator	North America
Dimensions (mm)	29.0 × 32.0 × 2.4
Temperature Ranges	
Operating Temperature	-35 °C to +75 °C
Extended Temperature	-40 °C to +85 °C
Frequency Bands	
LTE-FDD	B2/4/5/12/13/14/66/71
LTE-TDD	-
WCDMA	B2/4/5
GSM/EDGE	-
GNSS (Optional)	GPS/GLONASS/BDS/Galileo/QZSS

Source: Quectel EC25 Series

CONFIDENTIAL

# US 11,349,200 - Fleet Hoster FleetFlix Lite Pro+

## Claim 11

[11e] the first antenna defining an antenna contour comprising an entire perimeter of the first antenna,

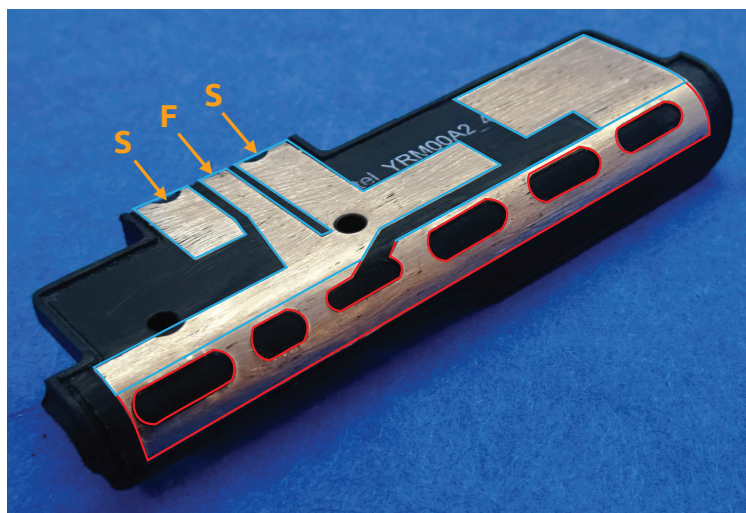

[11e] The first antenna defines a first antenna contour (indicated in blue and red) comprising an entire perimeter of the first antenna

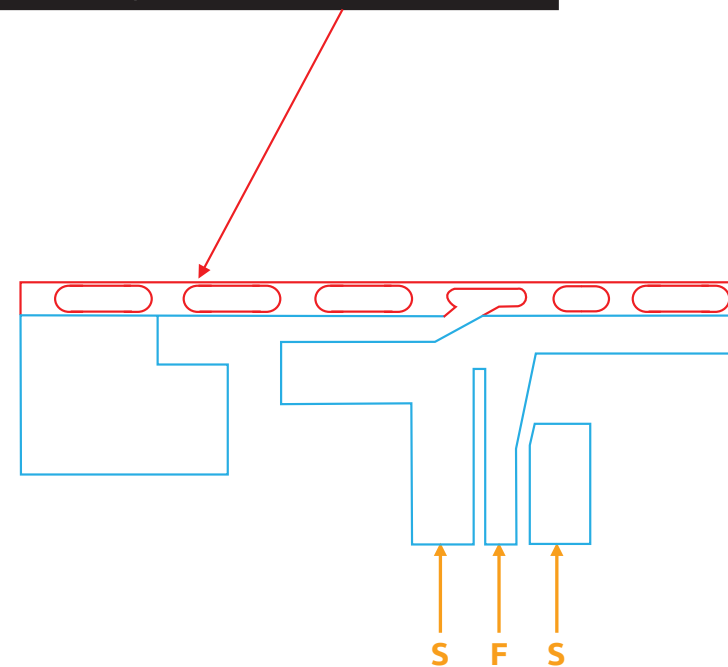

CONFIDENTIAL

# US 11,349,200 - Fleet Hoster FleetFlix Lite Pro+

## Claim 11

[11f] the antenna contour comprising at least twenty segments,

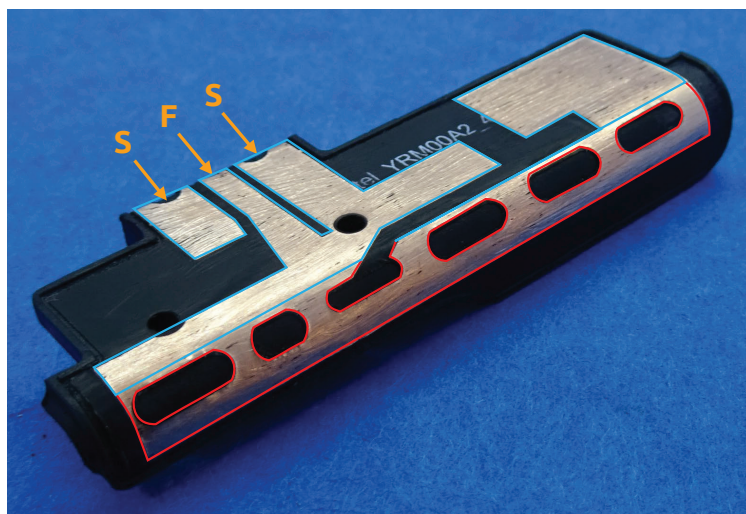

[11f] The first antenna contour (indicated in blue and red) comprises at least 20 segments

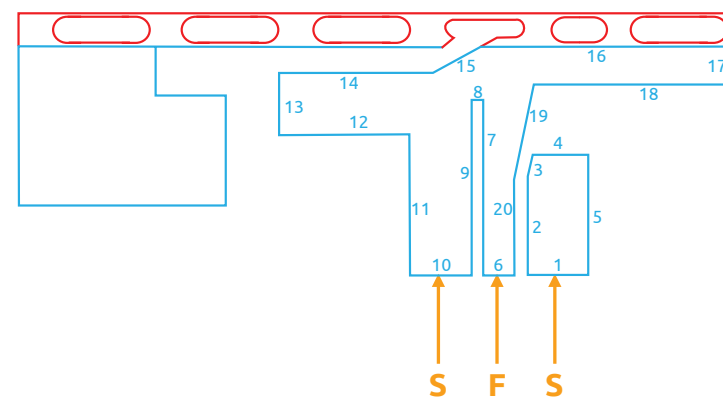

CONFIDENTIAL

# US 11,349,200 - Fleet Hoster FleetFlix Lite Pro+

## Claim 11

[11g] wherein the antenna contour has a level of complexity defined by complexity factor  $F_{21}$  having a value of at least 1.20 and

[11g] The first antenna contour has a level of complexity defined by complexity factor  $F_{21}$  having a value of at least 1.20

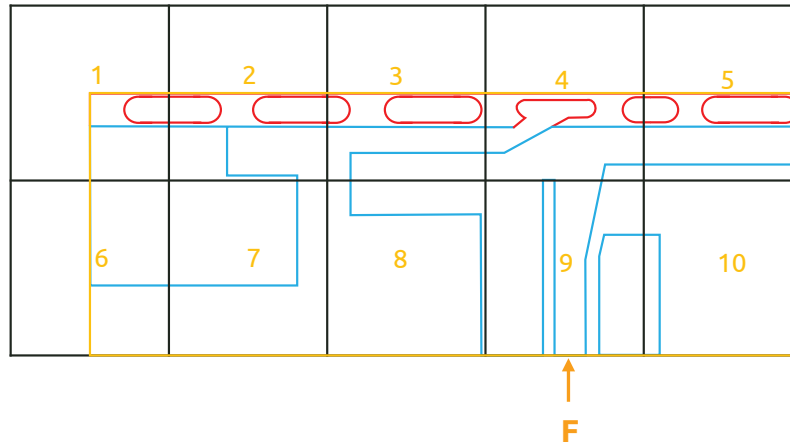

$N_1 = 10$  cells

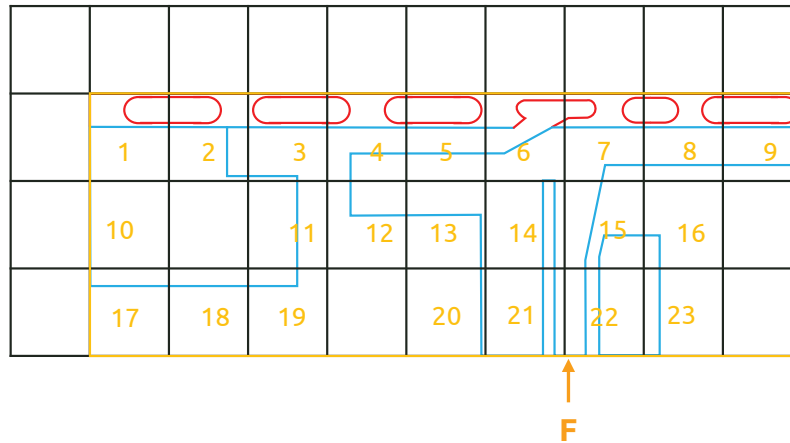

$N_2 = 23$  cells

$$F_{21} = -\frac{\log(N_2) - \log(N_1)}{\log\left(\frac{1}{2}\right)} = \frac{\log(23/10)}{\log(2)} = 1.201 \geq 1.20$$

CONFIDENTIAL

# US 11,349,200 - Fleet Hoster FleetFlix Lite Pro+

## Claim 11

[11h] complexity factor  $F_{32}$  having a value of at least 1.35, and

[11h] The first antenna contour has a level of complexity defined by complexity factor  $F_{32}$  having a value of at least 1.35

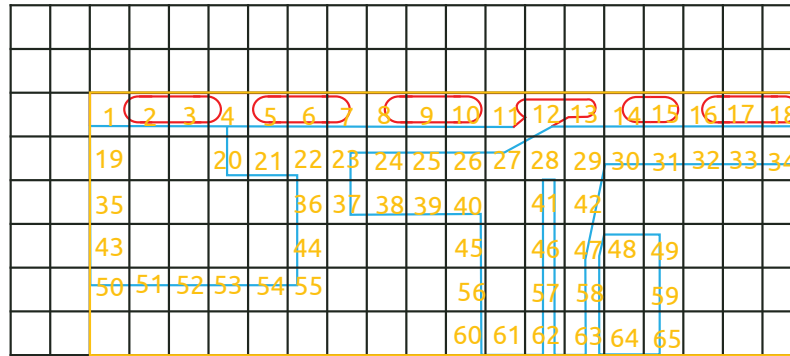

$N_3 = 65$  cells

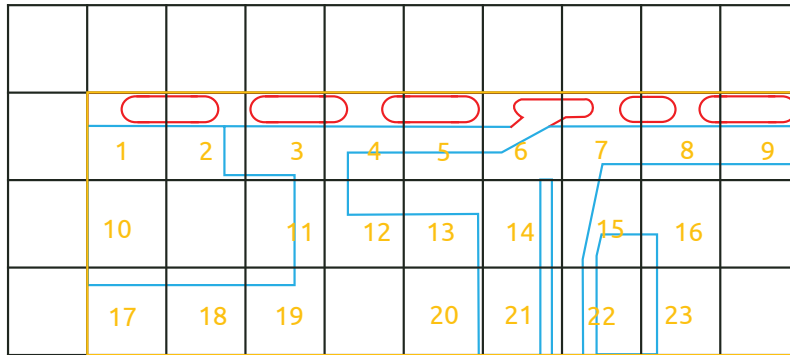

$N_2 = 23$  cells

$$F_{32} = -\frac{\log(N_3) - \log(N_2)}{\log\left(\frac{1}{2}\right)} = \frac{\log(65/23)}{\log(2)} = 1.50 \geq 1.35$$

CONFIDENTIAL

## US 11,349,200 - Fleet Hoster FleetFlix Lite Pro+

### Claim 11

[11i] wherein the first antenna defines an antenna box that is a minimum-sized parallelepiped that completely encloses a volume of the first antenna and  
[11j] wherein each face of the minimum-sized parallelepiped is tangent to at least one point of the volume of the first antenna,

[11i] The first antenna defines an antenna box (outlined in pink) that is a minimum-sized parallelepiped that completely encloses a volume of the first antenna

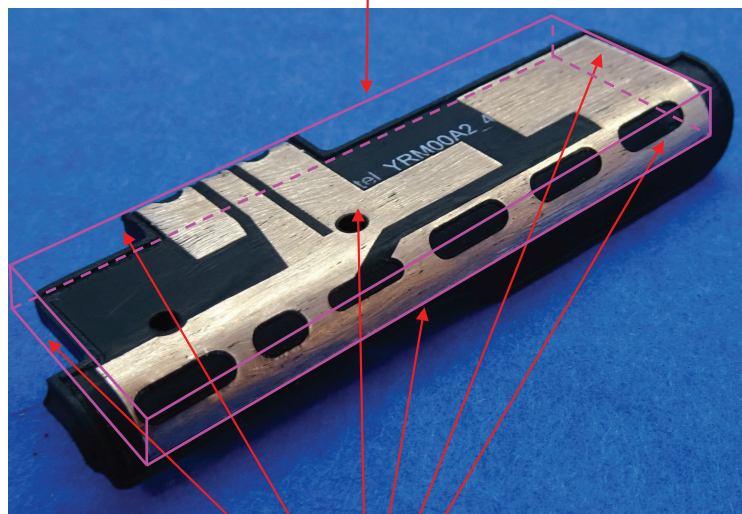

[11j] Each face of the minimum-sized parallelepiped is tangent to at least one point of the volume of the first antenna

**CONFIDENTIAL**

## US 11,349,200 - Fleet Hoster FleetFlix Lite Pro+

### Claim 11

[11k] an orthogonal projection of the antenna box along a normal to a face with a largest area of the first antenna defining [11l] an antenna rectangle,

[11l] Antenna rectangle  
(filled in green)

[11k] An orthogonal projection of the antenna box along a normal to a face\* with a largest area of the first antenna

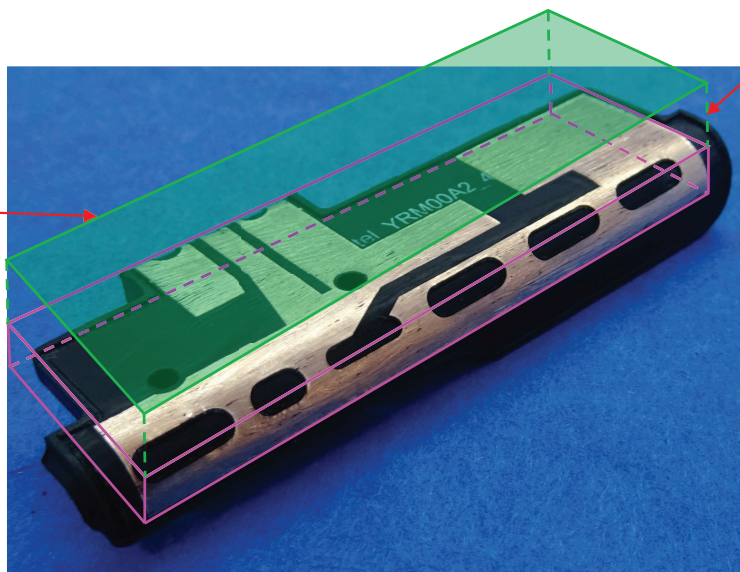

\*Normal to a face means perpendicular to the face

**CONFIDENTIAL**

## US 11,349,200 - Fleet Hoster FleetFlix Lite Pro+

### Claim 11

[11m] an aspect ratio of the antenna rectangle being defined as a ratio between a width and a height of the antenna rectangle, wherein the aspect ratio has a value of at least 2; and

[11m] Aspect ratio of the antenna rectangle being defined as a ratio between a width and a height of the antenna rectangle, and wherein the aspect ratio has a value of  $51.9/19.2 = 2.70 \geq 2$

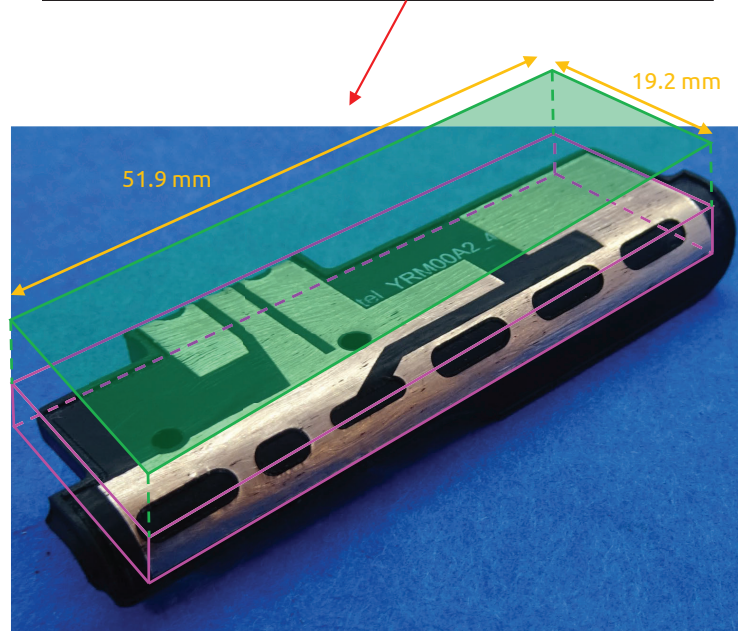

CONFIDENTIAL

# US 11,349,200 - Fleet Hoster FleetFlix Lite Pro+

## Claim 11

[11n] a second antenna configured to provide operation in a first wireless service, [11o] the second antenna being proximate to a side of a ground plane rectangle enclosing the ground plane.

[11n] The antenna system comprises a second antenna (indicated in blue) configured to provide operation in at least a first wireless service: WiFi 2.4GHz, and [11o] is proximate to a side of a ground plane rectangle (indicated with a dashed green line) enclosing the ground plane

### 4.2 General Description of EUT

Product Name:	Camera
Mode No.:	AD Plus2.0, AD Lite, C6 Lite
Test Model No.:	AD Plus2.0
Trade mark:	STREAMAX
EUT Supports Radios	2.4GHz Wi-Fi:

Source: FCC test report

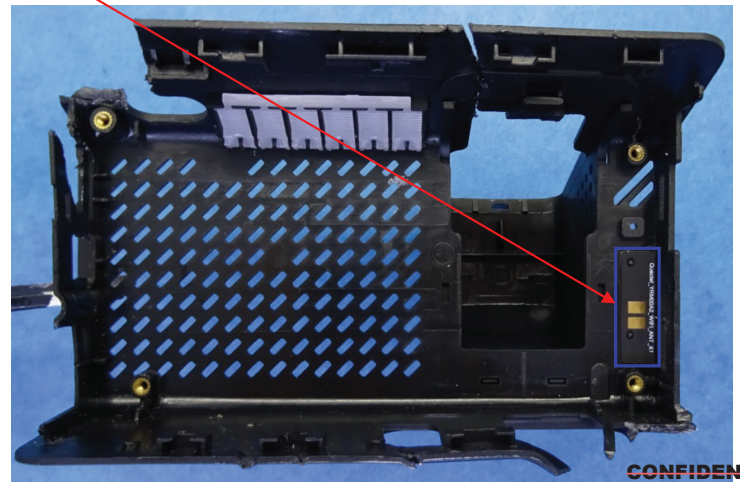
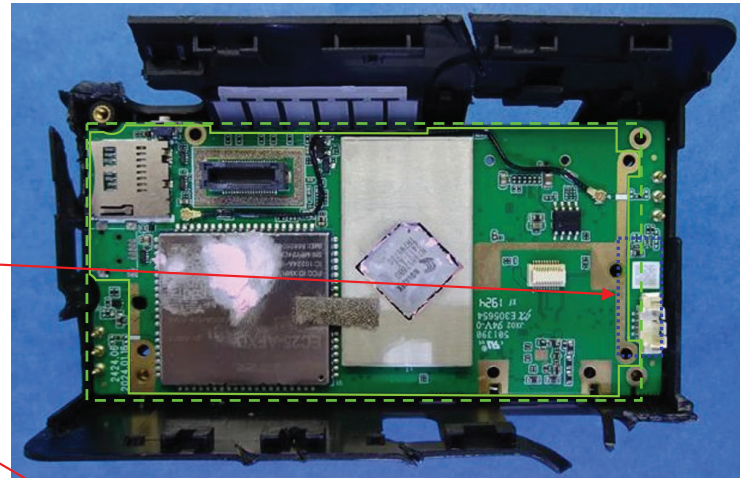

CONFIDENTIAL

# US 11,349,200 - Fleet Hoster FleetFlix Lite Pro+

## Claim 12

[12a] The wireless device of claim 11, wherein the first antenna is configured to support at least four frequency bands.

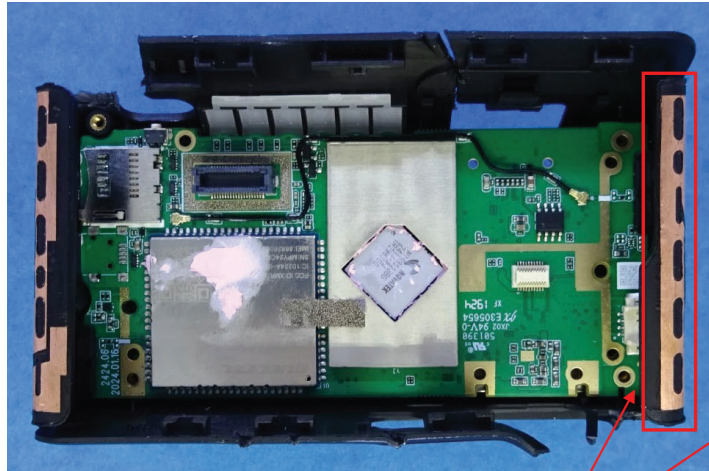

[12a] The first antenna (indicated in red) is configured to support at least LTE 700(B12)/850(B5)/2100(B4)/1900(B2)

LTE Cat 4	EC25-AFXD (Data-only)
Region/Operator	North America
Dimensions (mm)	29.0 × 32.0 × 2.4
Temperature Ranges	
Operating Temperature	-35 °C to +75 °C
Extended Temperature	-40 °C to +85 °C
Frequency Bands	
LTE-FDD	B2/4/5/12/13/14/66/71
LTE-TDD	-
WCDMA	B2/4/5
GSM/EDGE	-
GNSS (Optional)	GPS/GLONASS/BDS/Galileo/QZSS

Source: Quectel EC25 Series

CONFIDENTIAL

# US 11,349,200 - Fleet Hoster FleetFlix Lite Pro+

## Claim 13

[13a] The wireless device of claim 11, wherein the first wireless service is a WiFi communication standard.

[13a] The first wireless service is a WiFi communication standard

### 4.2 General Description of EUT

Product Name:	Camera
Mode No.:	AD Plus2.0 AD Lite, C6 Lite
Test Model No.:	AD Plus2.0
Trade mark:	STREAMAX
EUT Supports Radios	2.4GHz Wi-Fi:

Source: FCC test report

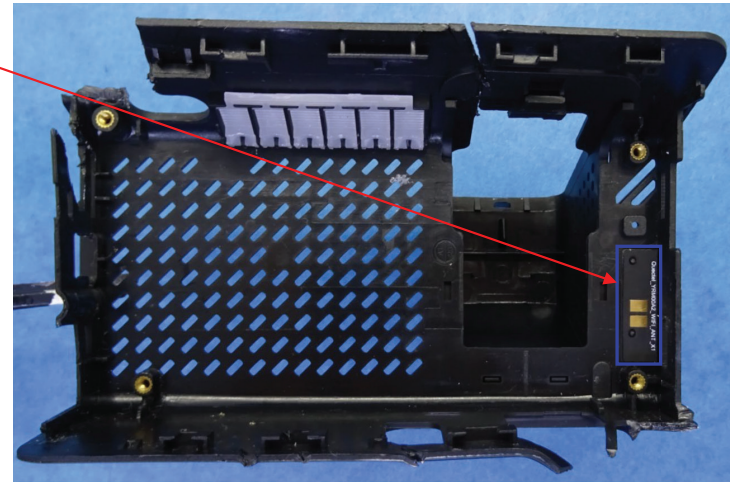

CONFIDENTIAL

## US 11,349,200 - Fleet Hoster FleetFlix Lite Pro+

### Claim 15

[15a] The wireless device of claim 11, wherein the antenna system comprises a third antenna.

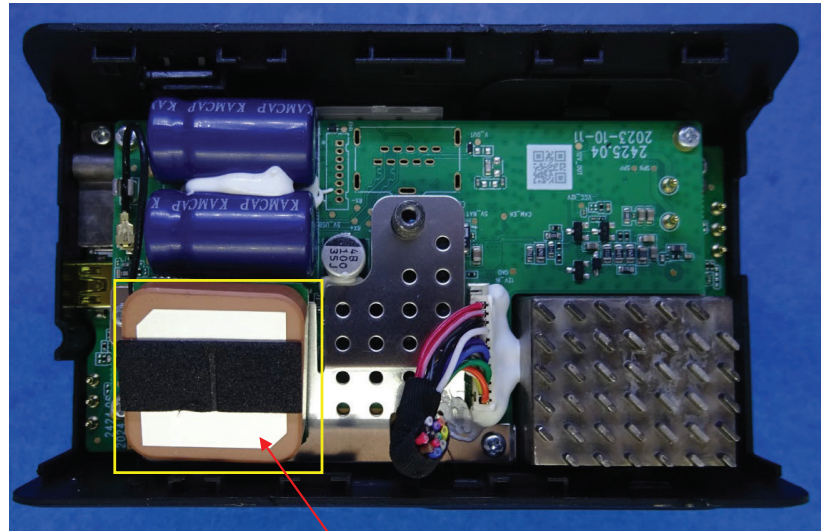

[15a] The antenna system comprises a third antenna (indicated in yellow)

CONFIDENTIAL

# US 11,349,200 - Fleet Hoster FleetFlix Lite Pro+

## Claim 17

[17a] The wireless device of claim 15, wherein the third antenna is configured to provide operation in a second wireless service.

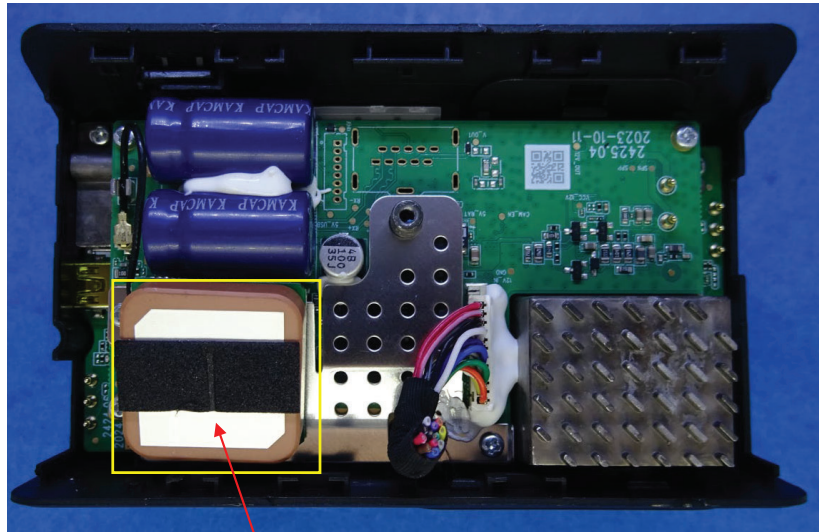

[17a] The third antenna (indicated in yellow) configured to provide operation in at least a second wireless service: GPS

Streamax

AD Plus2.0 User Manual

the set value in the sleep status.

6. **Low Volt Upload:** automatically reports the low voltage to the platform after being selected when the low voltage protection is triggered.
7. **Note:** When the low voltage protection is not enabled, 7 V is the judgment condition for low voltage protection by default.
8. **Sleep Upload:** reports the GPS information so that you can view the vehicle location information when the device restarts at regular intervals after the vehicle is turned off and goes online properly. The time interval cannot be modified for the time being, and the default is 5 minutes.

Source: device user manual

**CONFIDENTIAL**

## US 11,349,200 - Fleet Hoster FleetFlix Lite Pro+

### Claim 19

[19a] The wireless device of claim 15, wherein the antenna system comprises a fourth antenna.

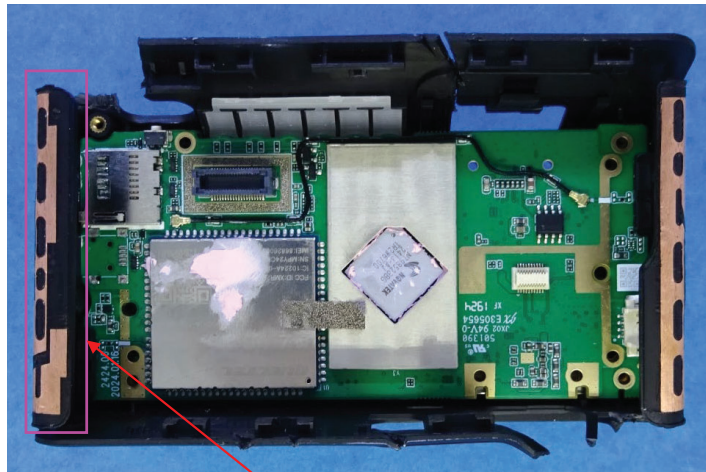

[19a] The antenna system comprises a fourth antenna (indicated in pink)

CONFIDENTIAL