

States certain semiconductor memory devices, including DRAM and NAND flash memory devices.

THE PARTIES

3. Plaintiff Palisade is a corporation organized and existing under the laws of Nevada, with its principal place of business in Gardnerville, Nevada.

4. On information and belief, Defendant Micron Technology Inc. (“MTI”) is a corporation organized and existing under the laws of the State of Delaware. MTI is registered to do business in Texas. MTI has a regular and established place of business located at 101 West Louis Henna Boulevard, Suite 210, Austin, Texas 78728. *See, e.g.*, <https://www.micron.com/about/locations>. MTI can be served with process through its registered agent for service of process, Corporation Service Company, at 211 E. 7th Street, Suite 620, Austin, Texas 78701-3128.

5. On information and belief, Defendant Micron Semiconductor Products, Inc. (“MSP”) is a corporation organized and existing under the laws of the State of Idaho. MSP is registered to do business in the State of Texas. MSP has a regular and established place of business located at 101 West Louis Henna Boulevard, Suite 210, Austin, Texas 78728. MSP can be served with process through its registered agent of process, Corporation Service Company, at 211 E. 7th Street, Suite 620, Austin, Texas 78701-3128. MSP is a wholly owned subsidiary of MTI. MTI does not separately report revenue from MSP in its public filings submitted to the Securities and Exchange Commission (“SEC”).

6. On information and belief, MSP is a wholly owned subsidiary of MTI. MTI does not separately report revenue from Micron Semiconductor in its filings to the Securities Exchange Commission, but rather reports combined revenue from its various products and subsidiaries.

7. On information and belief, Defendants have semiconductor fabrication plants in the United States and other countries throughout the world and manufacture memory products such as DRAM, NAND Flash, and NOR Flash at those plants. Defendants also use, sell, and offer for sale in the United States, import into the United States and/or export from the United States memory products, including solid state storage devices and memory modules, such as LPDDR5 (“Accused Products”). Defendants have at least imported, advertised, distributed, used, sold, or offered to sell products and services, including the Accused Products, in this judicial district, e.g., through sales and distribution channels managed by its agents and affiliates.

8. On information and belief, Defendants place, have placed, and contributed to placing Accused Products into the stream of commerce via an established distribution channel knowing or understanding that such products would be sold and used in the United States, including in this judicial district. Defendants have also derived substantial revenues from infringing acts in this judicial district, including from the sale and use of the Accused Products.

JURISDICTION AND VENUE

9. This is an action for patent infringement arising under the patent laws of the United States, 35 U.S.C. §§ 1, *et seq.* This Court has jurisdiction over this action pursuant to 28 U.S.C. §§ 1331, 1338(a) and 1367.

10. This Court has specific and personal jurisdiction over Micron consistent with the requirements of the Due Process Clause of the United States Constitution and the Texas Long Arm Statute because, *inter alia*, (i) Micron has done and continues to do business in Texas, and (ii) Micron has committed and continues to commit, directly or through intermediaries (including subsidiaries, distributors, affiliates, retailers, suppliers, integrators, customers, and others), acts of patent infringement in this State. Such acts of infringement include making, using, offering to sell,

and/or selling Accused Products (as more particularly identified and described throughout this Complaint, below) in this State and this District and/or importing Accused Products into this State and/or inducing others to commit acts of patent infringement in this State. Indeed, Micron has purposefully and voluntarily placed, and is continuing to place, one or more Accused Products into the stream of commerce through established distribution channels (including the Internet) with the expectation and intent that such products will be sold to and purchased by consumers in the United States, this State, and this District; and with the knowledge and expectation that such products (whether in standalone form or as integrated in downstream products) will be imported into the United States, this State, and this District.

11. Micron has derived substantial revenues from its infringing acts occurring within this State and this District. It has substantial business in this State and this District, including: (i) at least part of its infringing activities alleged herein; and (ii) regularly doing or soliciting business, engaging in other persistent conduct, and/or deriving substantial revenue from infringing goods offered for sale, sold, and imported, and services provided to Texas residents vicariously through and/or in concert with its alter egos, intermediaries, agents, distributors, importers, customers, subsidiaries, and/or consumers.

12. This Court has personal jurisdiction over Micron, Micron regularly conducts business and has committed acts of patent infringement and/or has induced acts of patent infringement by others in this District and/or has contributed to patent infringement by others in this District, the State of Texas, and elsewhere in the United States. Further, this Court has personal jurisdiction over Micron through intermediaries (including subsidiaries, distributors, affiliates, retailers, suppliers, integrators, customers, and others). Through direction and control of such intermediaries, Micron has committed acts of direct and/or indirect patent infringement within this

State and elsewhere within the United States giving rise to this action and/or has established minimum contacts with this forum such that the exercise of personal jurisdiction over Micron would not offend traditional notions of fair play and substantial justice.

13. In addition, Micron has knowingly induced, and continues to knowingly induce, infringement within this District by advertising, marketing, offering for sale and/or selling Accused Products (such as solid state storage devices and DRAM memory) that incorporate the fundamental technologies covered by the Asserted Patents. Such advertising, marketing, offering for sale and/or selling of Accused Products is directed to consumers, customers, manufacturers, integrators, suppliers, distributors, resellers, partners, and/or end users, and this includes providing instructions, user manuals, advertising, and/or marketing materials facilitating, directing and/or encouraging use of infringing functionality with Micron's knowledge thereof.

14. Micron has, thus, in the multitude of ways described above, availed itself of the benefits and privileges of conducting business in this State and willingly subjected itself to the exercise of this Court's personal jurisdiction over it. Indeed, Micron has sufficient minimum contacts with this forum through its transaction of substantial business in this State and this District and its commission of acts of patent infringement as alleged in this Complaint that are purposefully directed towards this State and District.

15. Micron has infringed or caused infringement in Texas, including in this Judicial District, by, among other things, promoting, offering for sale, distributing, and/or selling infringing products. Defendants have various physical locations in Texas, including within this Judicial District, at which Defendants transact business, conduct office and research operations, and recruit and hire employees. For example, Micron tests semiconductor memory devices, including at least NAND memory chips, in Austin, TX. Defendants also have authorized sellers and sales

representatives that offer for sale and sell infringing products to consumers at various locations throughout Texas and this Judicial District and Division, including but not limited to: Best Buy at 2511 W Loop 250 N in Midland, TX; Walmart Supercenter at 2450 NW Loop 338 State Rte W, Odessa, TX; and Amazon.com (which delivers infringing products throughout this Judicial District). On information and belief, Defendants intend for customers to use their products within this Judicial District. Therefore, the exercise of jurisdiction over Defendants is appropriate under the applicable jurisdictional statutes and would not offend traditional notions of fair play and substantial justice.

16. Venue is proper in this district for Defendants pursuant to 28 U.S.C. § 1400(b). Each of the Defendants committed and continues to commit acts of patent infringement in this District, including making, using, offering to sell, and/or selling accused products in this District, and/or importing accused products into this District, including by Internet sales and sales via retail and wholesale stores, inducing others to commit acts of patent infringement in Texas, and/or committing at least a portion of any other infringements alleged herein in this District. Each of the Defendants has a regular and established places of business in this district, including at least at 101 West Louis Henna Boulevard, Suite 210, Austin, Texas 78728. *See, e.g.*, <https://www.micron.com/about/locations>.

THE ASSERTED PATENTS

17. Palisade is the sole and exclusive owner of all right, title, and interest in the '962 patent, '838 patent, '051 patent, '314 patent, and '974 patent and holds the exclusive right to take all actions necessary to enforce its rights in, and to, the Asserted Patents, including the filing of this patent infringement lawsuit. Palisade also has the right to recover all damages for past, present, and future infringements of the Asserted Patents and to seek injunctive relief as appropriate under the law.

18. The '962 patent is titled "Transient Load Voltage Regulator." The '962 patent lawfully issued on April 3, 2012, and stems from U.S. Patent Application No. 12/464,301, which was filed on May 12, 2009.

19. The '838 patent is titled "Structure Variation Detection for a Memory Having a Three-Dimensional Memory Configuration." The '838 patent lawfully issued on March 31, 2015, and stems from U.S. Patent Application No. 14/273,031, which was filed on May 8, 2014.

20. The '051 patent is titled "Portable Handheld Memory Card and Methods for Use Therewith." The '051 patent lawfully issued on December 4, 2012, and stems from U.S. Patent Application No. 11/986,389, which was filed on November 20, 2007.

21. The '314 patent is titled "Non-Volatile Storage Having Oxide/Nitride Sidewall." The '314 patent lawfully issued on March 8, 2016, and stems from U.S. Patent Application No. 14/511,834, which was filed on October 10, 2014.

22. The '974 patent is titled "Alternating Sidewall Assisted Patterning." The '974 patent lawfully issued on December 20, 2016, and stems from U.S. Patent Application No. 14/806,111, which was filed on July 22, 2015.

23. Palisade and its predecessors complied with the requirements of 35 U.S.C. § 287, to the extent necessary, such that Palisade may recover pre-suit damages.

24. The claims of the Asserted Patents are directed to patent eligible subject matter under 35 U.S.C. § 101. They are not directed to an abstract idea, and the technologies covered by the claims comprise devices, systems and/or consist of ordered combinations of features and functions that, at the time of invention, were not, alone or in combination, well-understood, routine, or conventional.

COUNT I

(INFRINGEMENT OF U.S. PATENT NO. 8,148,962)

25. Plaintiff incorporates the preceding paragraphs herein by reference.

26. This cause of action arises under the patent laws of the United States, and, in particular, 35 U.S.C. §§ 271, *et seq.*

27. Palisade is the owner of all substantial rights, title, and interest in and to the '962 patent including the right to exclude others and to enforce, sue, and recover damages for past infringements.

28. The '962 patent is valid, enforceable, and was duly and legally issued by the United States Patent and Trademark Office on April 3, 2012, after full and fair examination.

29. Defendants directly and/or indirectly infringed (by inducing infringement) one or more claims of the '962 patent in this District and elsewhere in Texas and the United States by making, using, selling, offering to sell, and/or importing, and by actively inducing others to make, use, sell, offer to sell, and/or import products containing voltage regulators, such as DRAM, and/or products containing the same that incorporate the fundamental technologies covered by the '962 patent, including, but not limited to, the Micron MT62F1G64D4ZV-026 WT:B (the "'962 Accused Products").

Direct Infringement (35 U.S.C. § 271(a))

30. Defendants directly infringed one or more claims of the '962 patent in this District and elsewhere in Texas and the United States.

31. Defendants directly infringed, either by itself or via its agent(s), at least Claim 1 of the '962 patent¹ as set forth under 35 U.S.C. § 271(a) by making, using, offering for sale, selling,

¹ Throughout this Complaint, wherever Palisade identifies specific claims of the Asserted Patents infringed by Defendants, Palisade expressly reserves the right to identify additional claims and

and/or importing the '962 Accused Products. Furthermore, Defendants made and sold the '962 Accused Products outside of the United States and either delivered those products to its customers, distributors, and/or subsidiaries in the United States, or, in the case that it delivered the '962 Accused Products outside of the United States, it did so intending and/or knowing that those products were destined for the United States and/or designed and designated for sale in the United States, thereby directly infringing the '962 patent. *See, e.g., Lake Cherokee Hard Drive Techs., L.L.C. v. Marvell Semiconductor, Inc.*, 964 F. Supp. 2d 653, 658 (E.D. Tex. 2013).

32. By way of illustration only, the '962 Accused Products comprise each and every element of claim 1 of the '962 patent. On information and belief, the '962 Accused Products comprise “a voltage regulator circuit integrated in an integrated circuit (IC) and adapted to provide a voltage from a power supply to a load under varying load conditions.” The '962 Accused Products comprise voltage regulators.

33. On information and belief, the voltage regulators in the '962 Accused Products comprise “an input adapted to receive a voltage from the power supply.” For example, the voltage regulators are configured to receive an input, Vdd, from a power supply.

34. On information and belief, the voltage regulators in the '962 Accused Products comprise “an output adapted to be coupled to said load.” For example, the voltage regulators are configured to provide an output, Vout, that is coupled to the load.

35. On information and belief, the voltage regulators in the '962 Accused Products comprise “a feedback circuit coupled to a first current path and including a feedback transistor, wherein said feedback circuit is constructed to maintain a voltage at a gate of said feedback

products in its infringement contentions in accordance with applicable local rules and the Court's case management orders. Specifically identified claims throughout this Complaint are provided for notice pleading only.

transistor substantially constant.” For example, the voltage regulators comprise a feedback circuit that includes a feedback transistor that is constructed so that the voltage at the gate of the feedback transistor is substantially constant. A current path goes through the feedback transistor into a programmable resistor divider. The resistor divider is coupled to an input of a differential amplifier. The output of the differential amplifier is coupled to the gate of the feedback transistor. As a result, the differential amplifier maintains the voltage at the gate of the feedback transistor at a substantially constant value.

36. On information and belief, the voltage regulators in the '962 Accused Products comprise “a first current supply circuit constructed to supply to a second current path a first current that is substantially constant.” For example, the first current supply circuit comprises a diode connected transistor that is connected on one end to Vdd and coupled to a second transistor. The gate of the second transistor is connected to the output of the feedback circuit. The diode connected transistor and second transistor supply a first current that is substantially constant. The circuitry in the '962 Accused Products is configured such that the first current feeds into a resistor that provides a second path.

37. On information and belief, the voltage regulators in the '962 Accused Products comprise “a second current supply circuit coupled to said first current supply circuit, said gate of said feedback transistor, and said output of said voltage regulator circuit and constructed to supply a second current to said second current path with a magnitude based on said voltage at said gate of said feedback transistor and a voltage at said output of said voltage regulator circuit.” For example, the second current supply circuit comprises a diode connected transistor that is connected on one end to Vdd and coupled to a second transistor. The gate of the second transistor is connected to the output of the voltage regulator circuit. The diode connected transistor and second transistor

supply a second current. The circuitry in the '962 Accused Products is configured such that the second current feeds into the same resistor that the first current feeds into via a second path. The first and second current supply circuits are coupled via a feedback path.

38. On information and belief, the voltage regulators in the '962 Accused Products comprise “a pass device including a gate coupled to said second current path and adapted to receive a signal based on said current of said second current path and supply a load current to said load via said output of said voltage regulator circuit with a magnitude based on said signal.” For example, the pass device comprises a transistor that is connected to Vdd and coupled to the second current path such that its gate is adjusted by a signal based on the second current. The pass device supplies a current for the output of the voltage regulator dependent on the signal.

39. On information and belief, the voltage regulators in the '962 Accused Products comprise “wherein said second current supply circuit is adapted to, via said pass device, cause an increase in magnitude of said load current supplied to said output if a voltage at said output decreases and cause a decrease in magnitude of said load current supplied to said output if a voltage at said output increases.” For example, the feedback circuit is configured to maintain a substantially constant output such that it causes an increase in magnitude if the voltage at the output decreases and causes a decrease in magnitude if the voltage at the output increases. The feedback circuit maintains this substantially constant output via the second current supply circuit and pass device.

40. On information and belief, the voltage regulators in the '962 Accused Products comprise “wherein said feedback circuit, said first current supply circuit, said second current supply circuit, and said pass device are integrated in an integrated circuit and referenced to said input of said voltage regulator circuit.” For example, the feedback circuit, the first current supply

circuit, the second current supply circuit, and the pass device are all on an integrated circuit and referenced to Vdd, as detailed above.

Post-Suit Indirect Infringement (Inducement – 35 U.S.C. § 271(b))

41. In addition and/or in the alternative to its direct infringements, Defendants have indirectly infringed one or more claims of the '962 patent by knowingly and intentionally inducing others, including its subsidiaries, distributors, affiliates, retailers, suppliers, integrators, importers, customers, and/or consumers, to directly infringe by making, using, offering to sell, selling and/or importing into the United States the '962 Accused Products.

42. Defendants have had knowledge of the '962 patent since the service of the original Complaint in this Action. Since receiving notice of its infringements, Defendants actively induced the direct infringements of its subsidiaries, distributors, affiliates, retailers, suppliers, integrators, importers, customers, and/or consumers as set forth under U.S.C. § 271(b). For example, on information and belief, Defendants induce subsidiaries such as Micron Semiconductor Asia PTE and Micron Technology Taiwan Inc. to import the '962 Accused Products into the United States. Such inducements have been committed with the knowledge that the acts induced constitute infringement of the '962 patent. On information and belief, Defendants intended to cause and took affirmative steps to induce infringement by, among other things, creating and disseminating advertisements and instructive materials that promote the infringing use of the '962 Accused Products; creating and/or maintaining established distribution channels for the '962 Accused Products into and within the United States; manufacturing the '962 Accused Products in conformity with U.S. laws and regulations; distributing or making available datasheets supporting use of the '962 Accused Products that promote their features, specifications, and applications; providing technical documentation and tools for the '962 Accused Products, such as white papers,

brochures, and/or manuals; promoting the incorporation of the '962 Accused Products into end-user products, testing and certifying features related to initializing a dynamic semiconductor memory device of a random access in the '962 Accused Products; and/or by providing technical support and/or related services for these products to purchasers in the United States.

Damages

43. On information and belief, despite having knowledge of the '962 patent and knowledge that it is directly and/or indirectly infringing one or more claims of the '962 patent since the above detailed knowledge, Micron has nevertheless continued its infringing conduct and disregarded an objectively high likelihood of infringement. Micron's infringing activities relative to the '962 patent have been, and continue to be, willful, wanton, malicious, in bad-faith, deliberate, consciously wrongful, flagrant, and an egregious case of misconduct beyond typical infringement such that Palisade is entitled to enhanced damages under 35 U.S.C. § 284 up to three times the amount found or assessed.

44. Palisade has been damaged as a result of Micron's infringing conduct described in this Count. Micron is, thus, liable to Palisade in an amount that adequately compensates Palisade for Micron's infringements, which, by law, cannot be less than a reasonable royalty, together with interest and costs as fixed by this Court under 35 U.S.C. § 284.

COUNT II

(INFRINGEMENT OF U.S. PATENT NO. 8,996,838)

45. Plaintiff incorporates the preceding paragraphs herein by reference.

46. This cause of action arises under the patent laws of the United States, and, in particular, 35 U.S.C. §§ 271, *et seq.*

47. Palisade is the owner of all substantial rights, title, and interest in and to the '838 patent including the right to exclude others and to enforce, sue, and recover damages for past infringements.

48. The '838 patent is valid, enforceable, and was duly and legally issued by the United States Patent and Trademark Office on March 31, 2015, after full and fair examination.

49. Micron directly and/or indirectly infringed (by inducing infringement) one or more claims of the '838 patent in this District and elsewhere in Texas and the United States by making, using, selling, offering to sell, and/or importing, and by actively inducing others to make, use, sell, offer to sell, and/or import products containing 3D NAND with 176 or more layers, such as packages laser marked as NV046, and/or products containing the same, such as the Micron 7450 Pro (collectively, the "'838 Accused Products").

Direct Infringement (35 U.S.C. § 271(a))

50. Micron directly infringed one or more claims of the '838 patent in this District and elsewhere in Texas and the United States.

51. Micron directly infringed, either by itself or via its agent(s), at least Claim 1 of the '838 patent as set forth under 35 U.S.C. § 271(a) by making, using, offering for sale, selling, and/or importing the '838 Accused Products, including by testing the '838 Accused Products in configurations as in the exemplary implementations discussed further below. Furthermore, Micron made and sold the '838 Accused Products outside of the United States and either delivered those products to its customers, distributors, and/or subsidiaries in the United States, or, in the case that it delivered the '838 Accused Products outside of the United States, it did so intending and/or knowing that those products were destined for the United States and/or designed and designated for sale in the United States, thereby directly infringing the '838 patent. *See, e.g., Lake Cherokee*

Hard Drive Techs., L.L.C. v. Marvell Semiconductor, Inc., 964 F. Supp. 2d 653, 658 (E.D. Tex. 2013).

52. By way of illustration only, the '838 Accused Products perform a method comprising each and every step of claim 1 of the '838 patent. On information and belief, the '838 Accused Products performed the claimed steps in a data storage device that includes a memory having a three-dimensional (3D) memory configuration and including a structure extending through multiple layers of the memory. The '838 Accused Products comprise a 3D memory configuration that includes a structure extending through multiple layers of the memory. For example, the annotated image below of a representative '838 Accused Product demonstrates this:

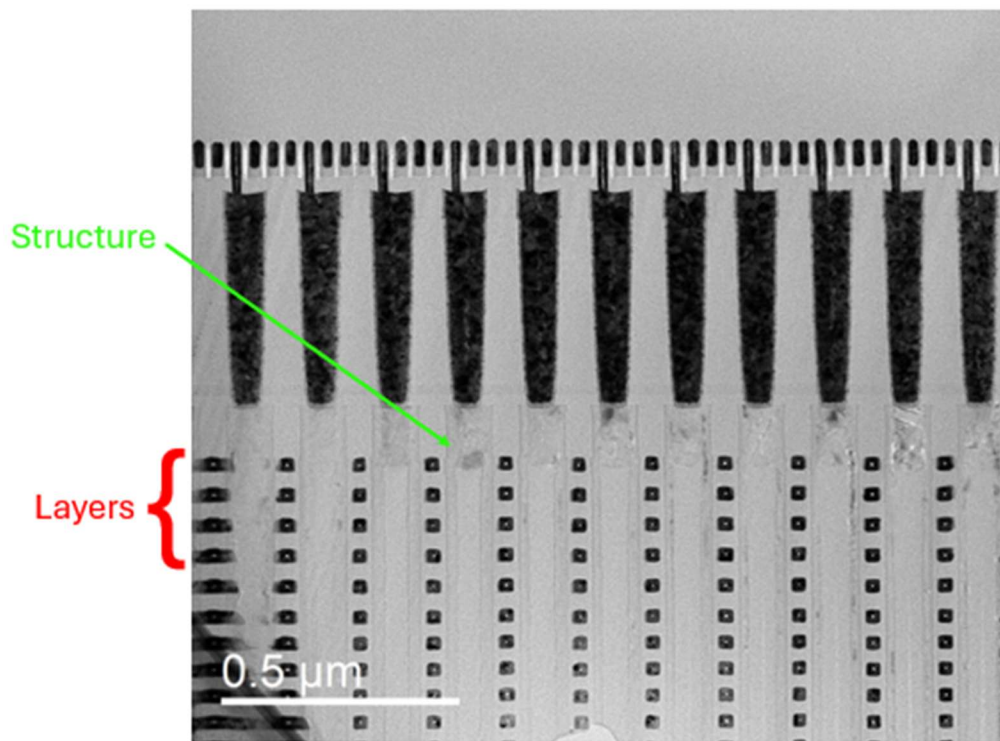

Figure 1 - TEM Image of Micron 7450

53. On information and belief, the '838 Accused Products store information at the data storage device, the information identifying a location associated with a variation of the structure. For example, the '838 Accused Products store information identifying a location associated with

a variation of the structure. As described by Micron’s Akira Goda in a paper titled “Recent Progress on 3D NAND Flash Technologies,” “[i]n the latest achievement, 176-layer stacked 3D NAND has been demonstrated in both publication and mass production.”²

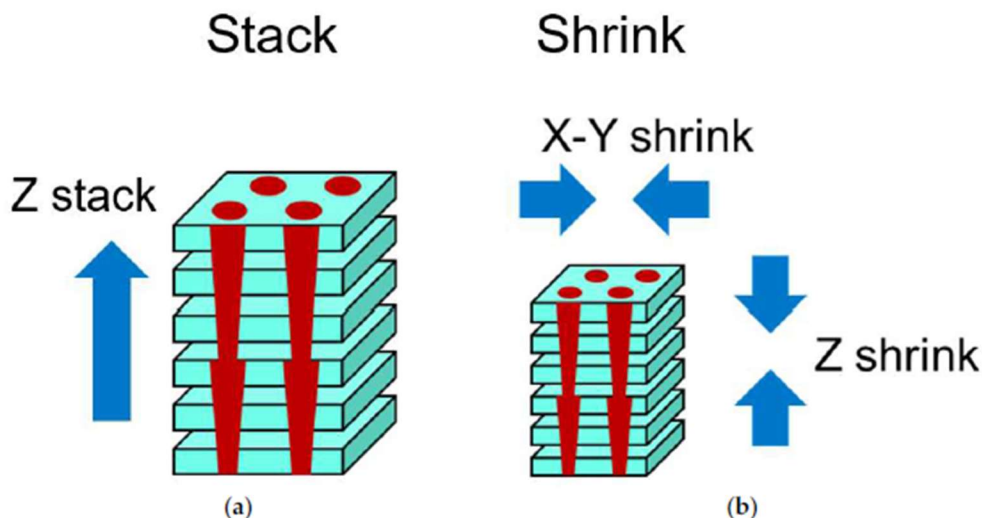

Figure 9. XYZ scaling of 3D NAND. (a) Layer stacking in Z-direction. (b) Footprint shrink of XY dimensions and layer pitch reduction as Z-shrink. Z-shrink is often combined with Z-stack to minimize the increase in the pillar height.

As Micron’s Mr. Goda notes, “[w]ith the WL [word line] pitch scaling, the trapped charge migration between the neighboring cells would raise the reliability concern.”³ And, “large write parallelism (= page size × number of planes) and short tProg are critical to achieve high write bandwidth.”⁴ “The improvements in tProg are realized by combinations of WL and BL bias time reduction, *fine tuning of the programming voltage compensating cell characteristics’ variability across the pillar* and the reduction in the program verify operations.”⁵

54. On information and belief, the ’838 Accused Products access the information. For example, the ’838 Accused Products access the information (i.e., the information identifying a

² Ex. A – Akira Goda, *Recent Progress on 3D NAND Flash Technologies*, at 5 (available at <https://www.mdpi.com/2079-9292/10/24/3156>).

³ *Id.* at 7.

⁴ *Id.* at 9.

⁵ *Id.* (emphasis added).

location associated with a variation of the structure) in order to determine the finely tuned programming voltage noted above.

Indirect Infringement (Inducement – 35 U.S.C. § 271(b))

55. In addition and/or in the alternative to its direct infringements, Defendants have indirectly infringed one or more claims of the '838 patent by knowingly and intentionally inducing others, including its subsidiaries, distributors, affiliates, retailers, suppliers, integrators, importers, customers, and/or consumers, to directly infringe by making, using, offering to sell, selling and/or importing into the United States the '838 Accused Products.

56. Defendants have had knowledge of the '838 patent since at least as early as June 7, 2017 when an examiner cited the '838 patent against MTI's U.S. Patent Application No. 15/381,432. Further, Defendants have had knowledge of the '838 patent no later than August 28, 2018 when U.S. Patent Application No. 15/381,432 issued as U.S. Patent No. 10,061,643, assigned to MTI, which cited the '838 patent on its face. Further still, Defendants have had knowledge of the '838 patent since at least the service of the original Complaint in this Action. Since receiving notice of its infringements, Defendants actively induced the direct infringements of its subsidiaries, distributors, affiliates, retailers, suppliers, integrators, importers, customers, and/or consumers as set forth under U.S.C. § 271(b). For example, on information and belief, Defendants induce subsidiaries such as Micron Semiconductor Asia PTE and Micron Technology Taiwan Inc. to import the '838 Accused Products into the United States. Such inducements have been committed with the knowledge, or with willful blindness to the fact, that the acts induced constitute infringement of the '838 patent. On information and belief, Defendants intended to cause and took affirmative steps to induce infringement by, among other things, creating and disseminating advertisements and instructive materials that promote the infringing use of the '838 Accused

Products; creating and/or maintaining established distribution channels for the '838 Accused Products into and within the United States; manufacturing the '838 Accused Products in conformity with U.S. laws and regulations; distributing or making available datasheets supporting use of the '838 Accused Products that promote their features, specifications, and applications; providing technical documentation and tools for the '838 Accused Products, such as white papers, brochures, and/or manuals; promoting the incorporation of the '838 Accused Products into end-user products, testing and certifying features related to initializing a dynamic semiconductor memory device of a random access in the '838 Accused Products; and/or by providing technical support and/or related services for these products to purchasers in the United States.

Damages

57. On information and belief, despite having knowledge of the '838 patent and knowledge that it is directly and/or indirectly infringing one or more claims of the '838 patent since the above detailed knowledge, Micron has nevertheless continued its infringing conduct and disregarded an objectively high likelihood of infringement. Micron's infringing activities relative to the '838 patent have been, and continue to be, willful, wanton, malicious, in bad-faith, deliberate, consciously wrongful, flagrant, and an egregious case of misconduct beyond typical infringement such that Palisade is entitled to enhanced damages under 35 U.S.C. § 284 up to three times the amount found or assessed.

58. Palisade has been damaged as a result of Micron's infringing conduct described in this Court. Micron is, thus, liable to Palisade in an amount that adequately compensates Palisade for Micron's infringements, which, by law, cannot be less than a reasonable royalty, together with interest and costs as fixed by this Court under 35 U.S.C. § 284.

COUNT III

(INFRINGEMENT OF U.S. PATENT NO. 8,327,051)

59. Plaintiff incorporates the preceding paragraphs herein by reference.

60. This cause of action arises under the patent laws of the United States, and, in particular, 35 U.S.C. §§ 271, *et seq.*

61. Palisade is the owner of all substantial rights, title, and interest in and to the '051 patent including the right to exclude others and to enforce, sue, and recover damages for past and future infringements.

62. The '051 patent is valid, enforceable, and was duly and legally issued by the United States Patent and Trademark Office on December 4, 2012, after full and fair examination.

63. Micron has and continues to directly and/or indirectly infringe (by inducing infringement) one or more claims of the '051 patent in this District and elsewhere in Texas and the United States by making, using, selling, offering to sell, and/or importing, and by actively inducing others to make, use, sell, offer to sell, and/or import, Micron products, their components and processes, and/or products containing the same that incorporate the fundamental technologies covered by the '051 patent, including, but not limited to, SSDs comprising a USB-C port, such as the Crucial X9 portable SSD (collectively, the "'051 Accused Products").

Direct Infringement (35 U.S.C. § 271(a))

64. Micron has directly infringed and continues to directly infringe one or more claims of the '051 patent in this District and elsewhere in Texas and the United States.

65. Micron has directly infringed and continues to directly infringe, either by itself or via its agent(s), at least Claim 1 of the '051 patent as set forth under 35 U.S.C. § 271(a) by making, using, offering for sale, selling, and/or importing the '051 Accused Products, including by testing the '051 Accused Products in configurations as in the exemplary implementation discussed further

below. Furthermore, Micron makes and sells the '051 Accused Products outside of the United States and either delivers those products to its customers, distributors, and/or subsidiaries in the United States, or, in the case that it delivers the '051 Accused Products outside of the United States, it does so intending and/or knowing that those products are destined for the United States and/or designed and designated for sale in the United States, thereby directly infringing the '051 patent. *See, e.g., Lake Cherokee Hard Drive Techs., L.L.C. v. Marvell Semiconductor, Inc.*, 964 F. Supp. 2d 653, 658 (E.D. Tex. 2013).

66. By way of illustration only, the '051 Accused Products comprise each and every element of claim 1 of the '051 patent. On information and belief, the '051 Accused Products comprise “Universal Serial Bus (USB) port comprising a first set of pins.” For example, the port shown below comprises a USB port comprising a first set of pins that allow for communication with a USB Type-A device.



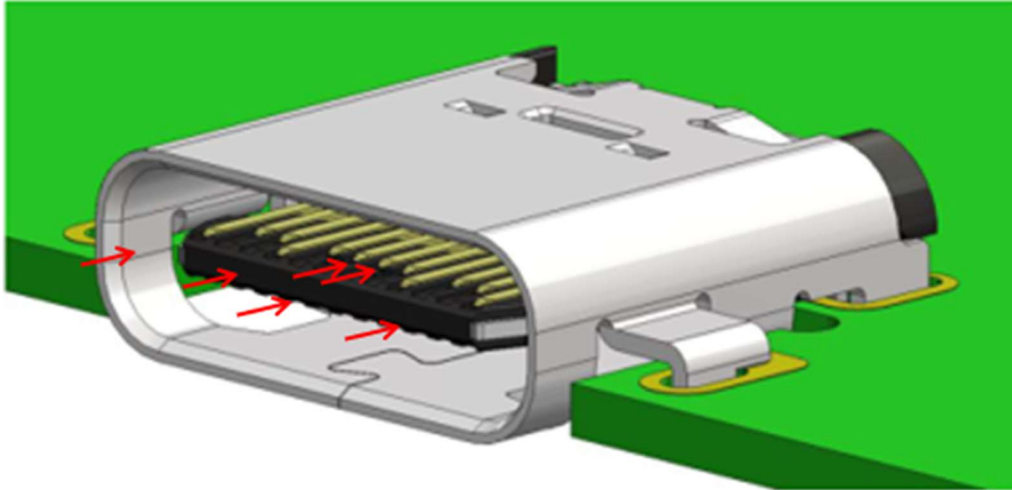

67. On information and belief, the '051 Accused Products comprise “USB controller circuitry electrically connected with the first set of pins of the USB port.” For example, first set of pins is electrically connected with a USB controller that controls the port functionality noted below in red.

Basic USB Type-C® System Implementation Model

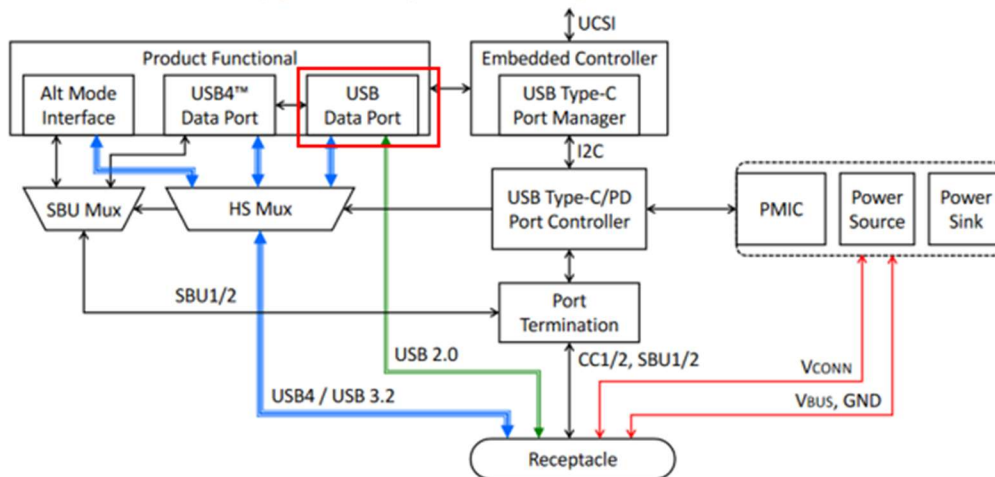

68. On information and belief, the '051 Accused Products comprise “an input/output (I/O) port comprising a second set of pins.” For example, the port shown below comprises an I/O port comprising a second set of pins that allow for communication with a USB Type-C device.

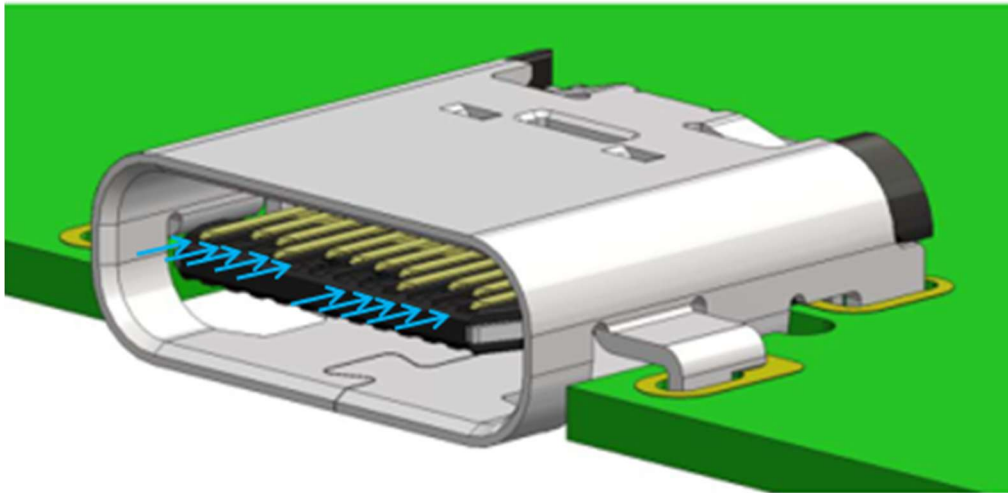

69. On information and belief, the '051 Accused Products comprise “I/O controller circuitry electrically connected with the second set of pins of the I/O port.” For example, second set of pins is electrically connected with an I/O controller that controls the port functionality noted below in red.

Basic USB Type-C® System Implementation Model

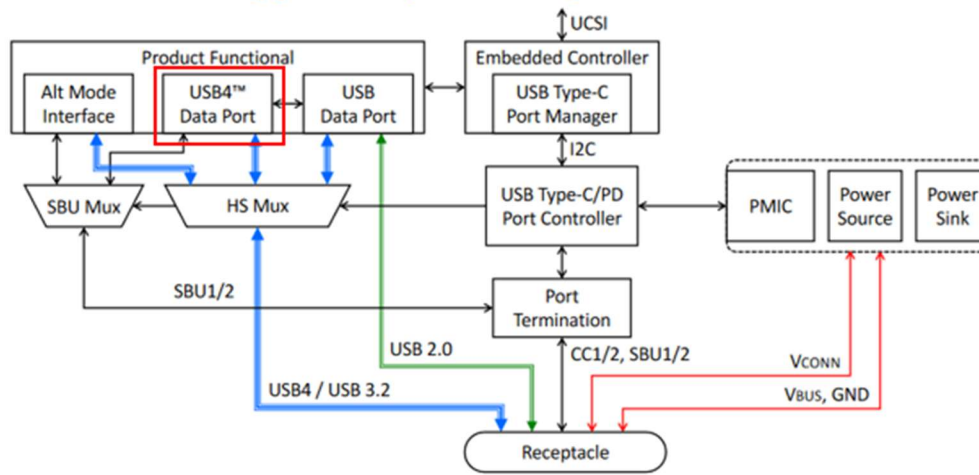

70. On information and belief, the '051 Accused Products comprise “a memory in communication with the USB port and the I/O port.” For example, the '051 Accused Products comprise NAND flash memory that is in communication with both ports as evidenced by the fact the '051 Accused Products can deliver data stored on the memory via either port.

71. On information and belief, the '051 Accused Products comprise “a housing storing the memory and exposing the USB port and the I/O port.” For example, the '051 Accused Products comprise a housing that stores the memory and exposes the USB port and the I/O port.



72. On information and belief, the '051 Accused Products are configured such that “the USB port and the I/O port are positioned on a same end to allow a same card-insertion direction irrespective of whether a host device comprises a mating USB port or a mating I/O port.” For example, the '051 Accused Products are configured such that the USB port and the I/O port are located on the same end. Further the ports are configured to allow for same card-insertion.

73. On information and belief, the '051 Accused Products are configured such that “the USB port and the I/O port are positioned such that when the I/O port is electrically connected with the host device, at least one of the first set of pins of the USB port is not electrically connected to the host device, and when the USB port is electrically connected to the host device, at least one of the second set of pins of the I/O port is not electrically connected to the host device.” For example, the '051 Accused Products are configured such that when the port is connected to a USB Type-A device, the first set of pins is electronically connected to the host device and at least one of the second set of pins is not electronically connected to the host device. Similarly, when the port is connected to a USB Type-C device, the second set of pins is electronically connected to the host device and at least one of the first set of pins, such as the DP/DN pin, is not electronically connected to the host device.

Post-Suit Indirect Infringement (Inducement – 35 U.S.C. § 271(b))

74. In addition and/or in the alternative to its direct infringements, Defendants have indirectly infringed one or more claims of the '051 patent by knowingly and intentionally inducing others, including its subsidiaries, distributors, affiliates, retailers, suppliers, integrators, importers, customers, and/or consumers, to directly infringe by making, using, offering to sell, selling and/or importing into the United States the '051 Accused Products.

75. Defendants have had knowledge of the '051 patent since the service of the original Complaint in this action. Since receiving notice of its infringements, Defendants actively induced the direct infringements of its subsidiaries, distributors, affiliates, retailers, suppliers, integrators, importers, customers, and/or consumers as set forth under U.S.C. § 271(b). For example, Defendants supply data sheets that encourage the use of the USB port on the '051 Accused Products. *See, e.g.*, Ex. B – Crucial X9 Data Sheet, p. 2. Such inducements have been committed with the knowledge that the acts induced constitute infringement of the '051 patent. On information and belief, Defendants intended to cause and took affirmative steps to induce infringement by, among other things, creating and disseminating advertisements and instructive materials that promote the infringing use of the '051 Accused Products; creating and/or maintaining established distribution channels for the '051 Accused Products into and within the United States; manufacturing the '051 Accused Products in conformity with U.S. laws and regulations; distributing or making available datasheets supporting use of the '051 Accused Products that promote their features, specifications, and applications; providing technical documentation and tools for the '051 Accused Products, such as white papers, brochures, and/or manuals; promoting the incorporation of the '051 Accused Products into end-user products, testing and certifying features related to initializing a dynamic semiconductor memory device of a random access in the '051 Accused Products; and/or by providing technical support and/or related services for these products to purchasers in the United States.

Damages

76. On information and belief, despite having knowledge of the '051 patent and knowledge that it is directly and/or indirectly infringing one or more claims of the '051 patent since the above detailed knowledge, Micron has nevertheless continued its infringing conduct and

disregarded an objectively high likelihood of infringement. Micron's infringing activities relative to the '051 patent have been, and continue to be, willful, wanton, malicious, in bad-faith, deliberate, consciously wrongful, flagrant, and an egregious case of misconduct beyond typical infringement such that Palisade is entitled to enhanced damages under 35 U.S.C. § 284 up to three times the amount found or assessed.

77. Palisade has been damaged as a result of Micron's infringing conduct described in this Count. Micron is, thus, liable to Palisade in an amount that adequately compensates Palisade for Micron's infringements, which, by law, cannot be less than a reasonable royalty, together with interest and costs as fixed by this Court under 35 U.S.C. § 284.

COUNT IV

(INFRINGEMENT OF U.S. PATENT NO. 9,281,314)

78. Plaintiff incorporates the preceding paragraphs herein by reference.

79. This cause of action arises under the patent laws of the United States, and, in particular, 35 U.S.C. §§ 271, *et seq.*

80. Palisade is the owner of all substantial rights, title, and interest in and to the '314 patent including the right to exclude others and to enforce, sue, and recover damages for past and future infringements.

81. The '314 patent is valid, enforceable, and was duly and legally issued by the United States Patent and Trademark Office on March 8, 2016, after full and fair examination.

82. Micron has and continues to directly and/or indirectly infringe (by inducing infringement) one or more claims of the '314 patent in this District and elsewhere in Texas and the United States by making, using, selling, offering to sell, and/or importing, and by actively inducing others to make, use, sell, offer to sell, and/or import products containing 3D NAND, such

as packages laser marked as NV046, and/or products containing the same, such as the Micron 7450 Pro (collectively, the “’314 Accused Products”).

Direct Infringement (35 U.S.C. § 271(a) and (g))

83. Micron has directly infringed and continues to directly infringe one or more claims of the ’314 patent in this District and elsewhere in Texas and the United States.

84. Micron has directly infringed and continues to directly infringe, either by itself or via its agent(s), at least Claim 13 of the ’314 patent as set forth under 35 U.S.C. § 271(a) by making, using, offering for sale, selling, and/or importing the ’314 Accused Products, including by testing the ’314 Accused Products in configurations as in the exemplary implementation discussed further below. Further, Micron has infringed certain claims of the ’314 patent under 35 U.S.C. § 271(g) by among other things, making, selling, offering for sale, and/or importing products the ’314 Accused Products that were made in a manner that satisfied the limitations of claim 13. Furthermore, Micron makes and sells the ’314 Accused Products outside of the United States and either delivers those products to its customers, distributors, and/or subsidiaries in the United States, or, in the case that it delivers the ’314 Accused Products outside of the United States, it does so intending and/or knowing that those products are destined for the United States and/or designed and designated for sale in the United States, thereby directly infringing the ’314 patent. *See, e.g., Lake Cherokee Hard Drive Techs., L.L.C. v. Marvell Semiconductor, Inc.*, 964 F. Supp. 2d 653, 658 (E.D. Tex. 2013).

85. By way of illustration only, on information and belief, the ’314 Accused Products are made using a method of manufacturing that infringes claim 13 of the ’314 patent. For example, the method of manufacturing of the ’314 Accused Products comprises “forming a plurality of lines

of memory cells.” This is illustrated by the purple boxes in the below cross section of a ’314 Accused Product:

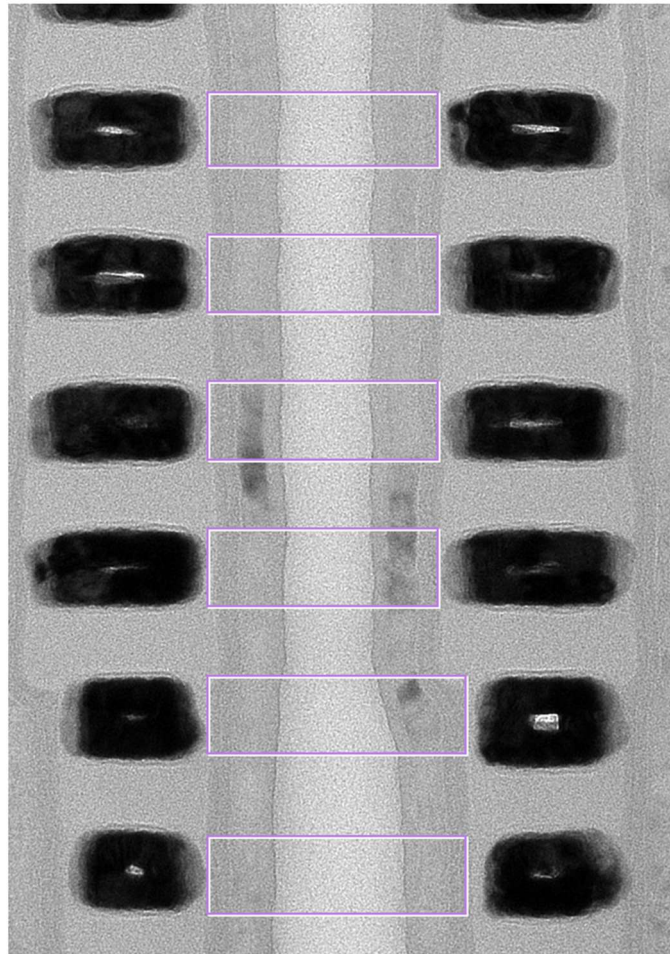

Figure 2 - TEM Image of Micron 7450

Further, the memory cells comprise “a charge storage region having sidewalls” and “a control gate.” For example, a top down view of the ’314 Accused Products shows a charge storage region having sidewalls and a control gate that consists of 1.5-2 nm TiN:

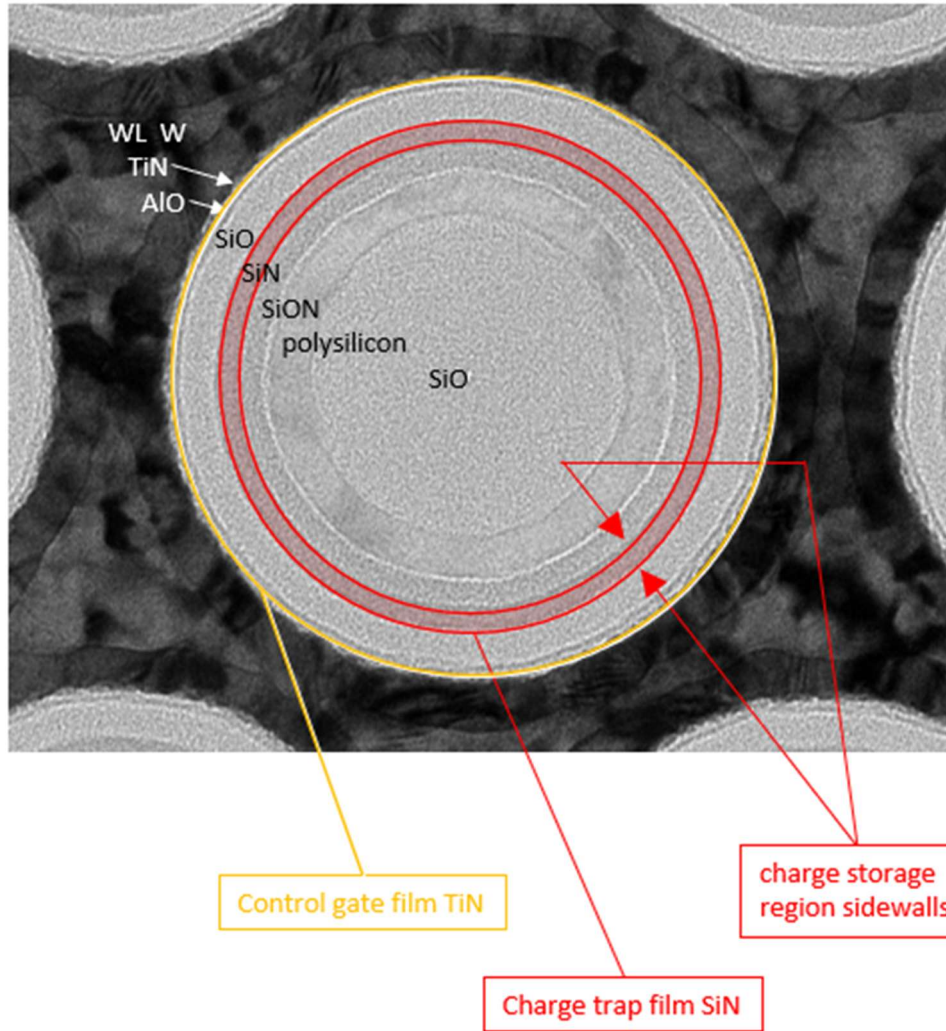

Figure 3 - TEM Image of Micron 7450

86. On information and belief, the method of manufacturing of the '314 Accused Products comprises “forming a plurality of word lines each having sidewalls, each of the word lines being associated with a line of the memory cells, each of the word lines being coupled to the control gates of the memory cells with which it is associated.” This is illustrated by the top down view of a '314 Accused Product showing the word lines are coupled to the control gate:

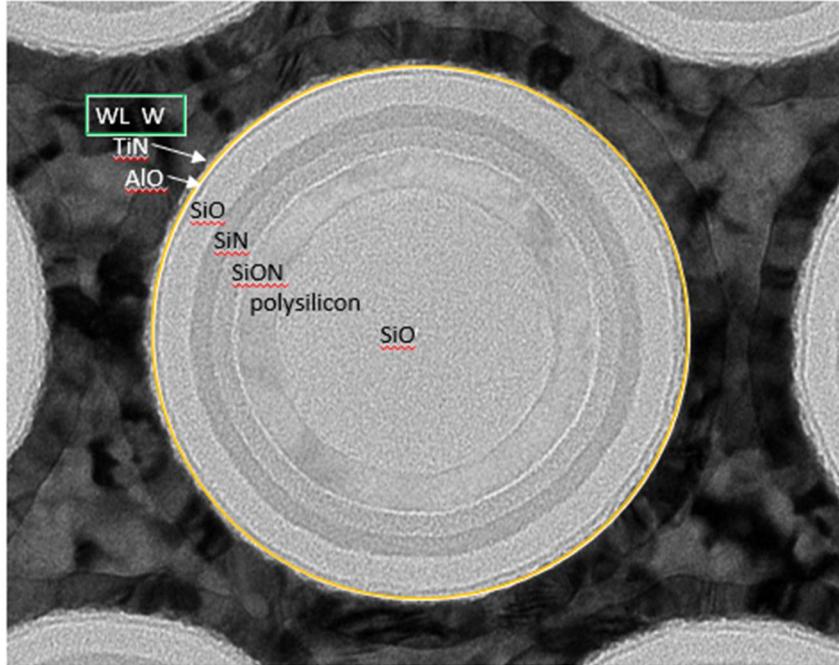

Figure 4 - TEM Image of Micron 7450

And the below cross section of a '314 Accused Product showing tungsten word lines that have side walls and are each coupled to the control gates of the memory cells:

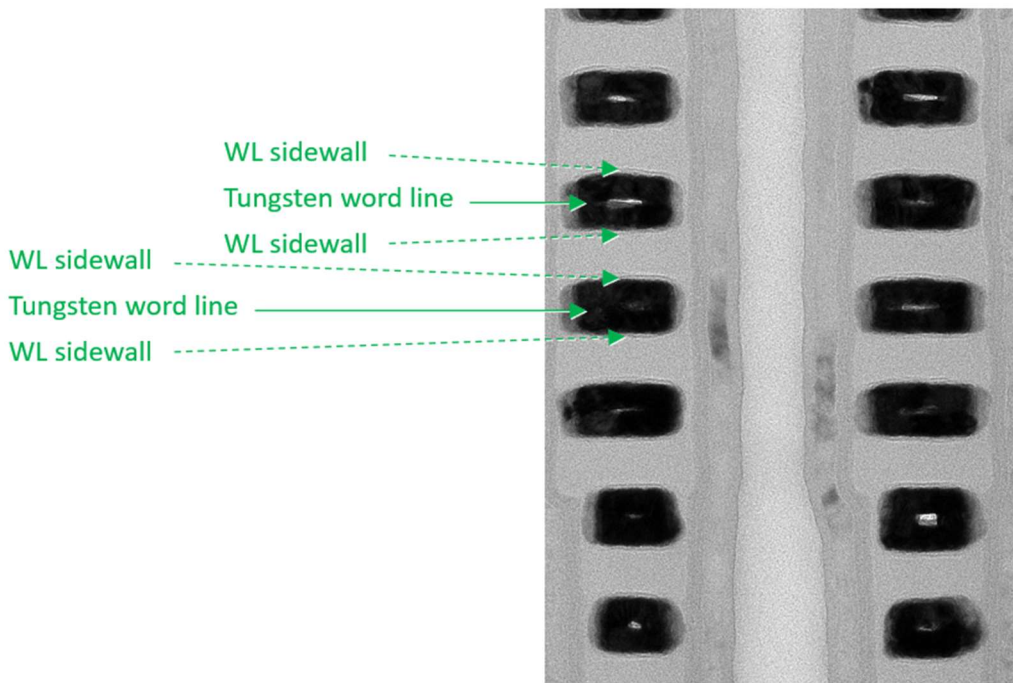

Figure 5 - TEM Image of Micron 7450

87. On information and belief, the method of manufacturing of the '314 Accused Products comprises “forming first oxide regions that cover the sidewalls of the charge storage regions.” For example, in the below cross section, the sidewalls of the charge storage regions are covered by a silicon oxide layer.

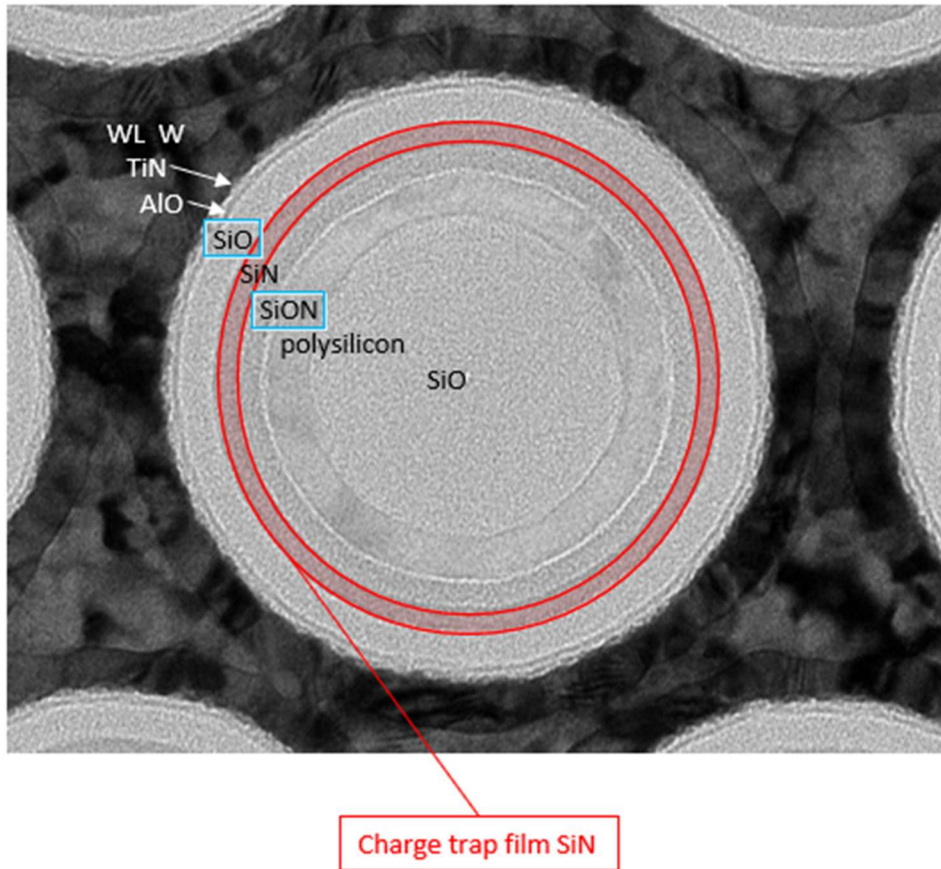

Figure 6 - TEM Image of Micron 7450

88. On information and belief, the method of manufacturing of the '314 Accused Products comprises “forming second oxide regions that cover the sidewalls of the word lines” and “forming nitride regions that cover the second oxide regions.” For example, the below cross section of a '314 Accused Product shows a second oxide region of aluminum oxide or silicon oxide that covers the sidewalls of the word lines and the second oxide region is covered in 1.5-2nm TiN.

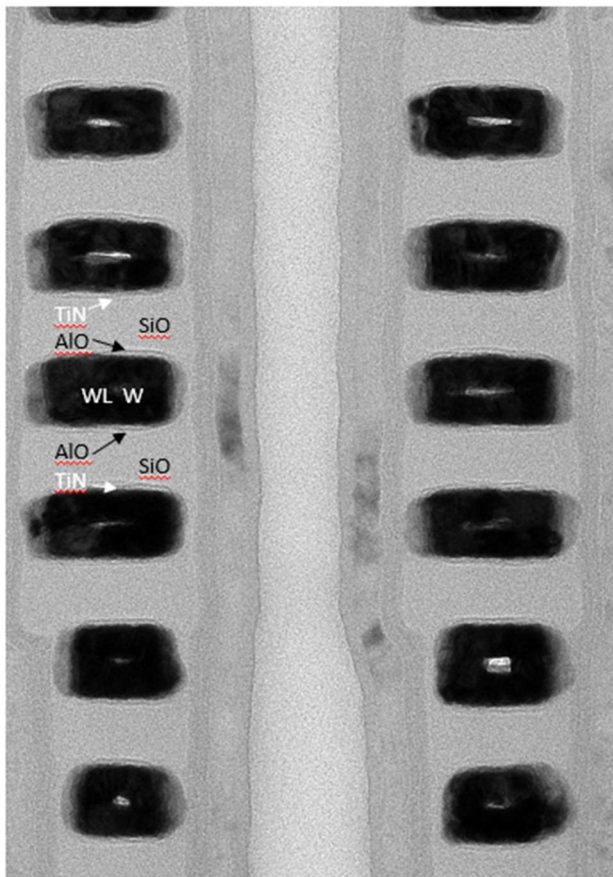

Figure 7 - TEM Image of Micron 7450

89. On information and belief, the method of manufacturing of the '314 Accused Products comprises “forming electrical isolation regions other than silicon nitride adjacent to the first oxide regions that cover the sidewalls of the charge storage regions.” For example, the below cross section of a '314 Accused Product shows a separate polysilicon region that is adjacent to the first oxide region and covers the charge storage region:

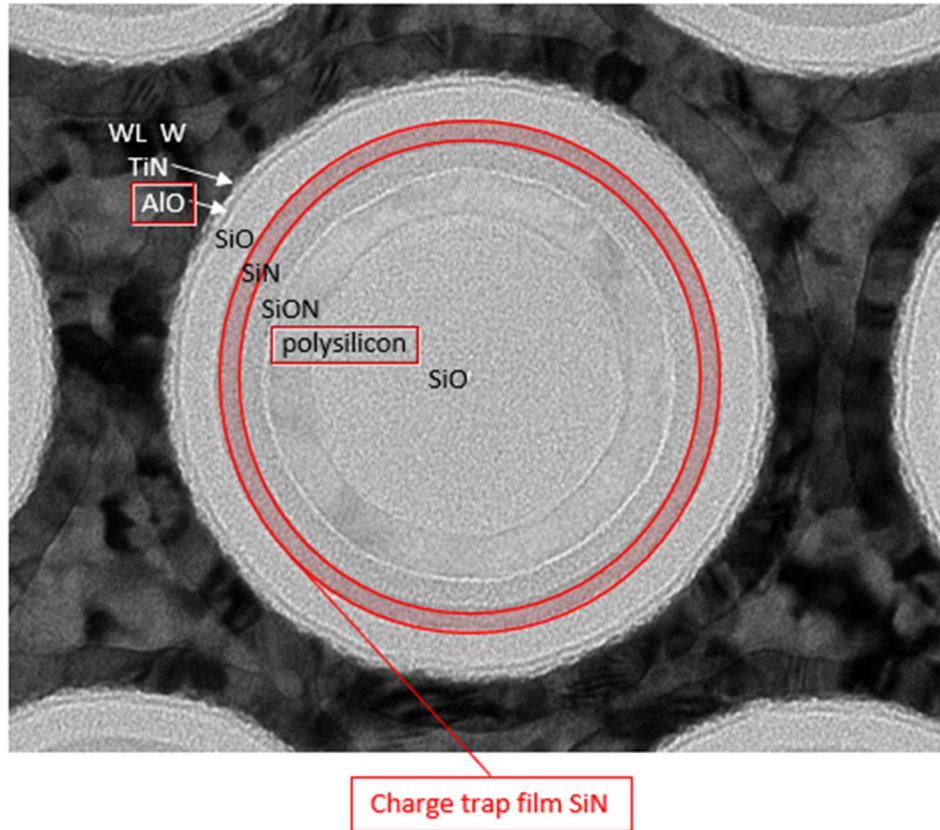

Figure 8 - TEM Image of Micron 7450

Post-Suit Indirect Infringement (Inducement – 35 U.S.C. § 271(b))

90. In addition and/or in the alternative to its direct infringements, Defendants have indirectly infringed one or more claims of the '314 patent by knowingly and intentionally inducing others, including its subsidiaries, distributors, affiliates, retailers, suppliers, integrators, importers, customers, and/or consumers, to directly infringe by making, using, offering to sell, selling and/or importing into the United States the '314 Accused Products.

91. Defendants have had knowledge of the '314 patent since the service of the original Complaint in this action. Since receiving notice of its infringements, Defendants actively induced the direct infringements of its subsidiaries, distributors, affiliates, retailers, suppliers, integrators, importers, customers, and/or consumers as set forth under U.S.C. § 271(b). For example, on information and belief, Defendants induce subsidiaries such as Micron Semiconductor Asia PTE

and Micron Technology Taiwan Inc. to import the '314 Accused Products into the United States. Such inducements have been committed with the knowledge that the acts induced constitute infringement of the '314 patent. On information and belief, Defendants intended to cause and took affirmative steps to induce infringement by, among other things, creating and disseminating advertisements and instructive materials that promote the infringing use of the '314 Accused Products; creating and/or maintaining established distribution channels for the '314 Accused Products into and within the United States; manufacturing the '314 Accused Products in conformity with U.S. laws and regulations; distributing or making available datasheets supporting use of the '314 Accused Products that promote their features, specifications, and applications; providing technical documentation and tools for the '314 Accused Products, such as white papers, brochures, and/or manuals; promoting the incorporation of the '314 Accused Products into end-user products, testing and certifying features related to initializing a dynamic semiconductor memory device of a random access in the '314 Accused Products; and/or by providing technical support and/or related services for these products to purchasers in the United States.

Damages

92. On information and belief, despite having knowledge of the '314 patent and knowledge that it is directly and/or indirectly infringing one or more claims of the '314 patent since the above detailed knowledge, Micron has nevertheless continued its infringing conduct and disregarded an objectively high likelihood of infringement. Micron's infringing activities relative to the '314 patent have been, and continue to be, willful, wanton, malicious, in bad-faith, deliberate, consciously wrongful, flagrant, and an egregious case of misconduct beyond typical infringement such that Palisade is entitled to enhanced damages under 35 U.S.C. § 284 up to three times the amount found or assessed.

93. Palisade has been damaged as a result of Micron's infringing conduct described in this Count. Micron is, thus, liable to Palisade in an amount that adequately compensates Palisade for Micron's infringements, which, by law, cannot be less than a reasonable royalty, together with interest and costs as fixed by this Court under 35 U.S.C. § 284.

COUNT V

(INFRINGEMENT OF U.S. PATENT NO. 9,524,974)

94. Plaintiff incorporates the preceding paragraphs herein by reference.

95. This cause of action arises under the patent laws of the United States, and, in particular, 35 U.S.C. §§ 271, *et seq.*

96. Palisade is the owner of all substantial rights, title, and interest in and to the '974 patent including the right to exclude others and to enforce, sue, and recover damages for past and future infringements.

97. The '974 patent is valid, enforceable, and was duly and legally issued by the United States Patent and Trademark Office on December 20, 2016, after full and fair examination.

98. Micron has and continues to directly and/or indirectly infringe (by inducing infringement) one or more claims of the '974 patent in this District and elsewhere in Texas and the United States by making, using, selling, offering to sell, and/or importing, and by actively inducing others to make, use, sell, offer to sell, and/or import products containing NAND, such as packages laser marked as NV046, and/or products containing the same, such as the Micron 7450 Pro (collectively, the "'974 Accused Products").

Direct Infringement (35 U.S.C. § 271(a) and (g))

99. Micron has directly infringed and continues to directly infringe one or more claims of the '974 patent in this District and elsewhere in Texas and the United States.

100. Micron has directly infringed and continues to directly infringe, either by itself or via its agent(s), at least Claim 1 of the '974 patent as set forth under 35 U.S.C. § 271(a) by making, using, offering for sale, selling, and/or importing the '974 Accused Products, including by testing the '974 Accused Products in configurations as in the exemplary implementation discussed further below. Further, Micron has infringed certain claims of the '974 patent under 35 U.S.C. § 271(g) by among other things, making, selling, offering for sale, and/or importing products the '974 Accused Products that were made in a manner that satisfied the limitations of claim 12. Furthermore, Micron makes and sells the '974 Accused Products outside of the United States and either delivers those products to its customers, distributors, and/or subsidiaries in the United States, or, in the case that it delivers the '974 Accused Products outside of the United States, it does so intending and/or knowing that those products are destined for the United States and/or designed and designated for sale in the United States, thereby directly infringing the '974 patent. *See, e.g., Lake Cherokee Hard Drive Techs., L.L.C. v. Marvell Semiconductor, Inc.*, 964 F. Supp. 2d 653, 658 (E.D. Tex. 2013).

101. By way of illustration only, the '974 Accused Products comprise each and every element of claim 1 of the '974 patent. On information and belief, the '974 Accused Products are NAND flash memory that comprise a semiconductor substrate. For example, as the below annotated cross section of a representative '974 Accused Product illustrates, the '974 Accused Products comprise a “semiconductor substrate,” a “dielectric layer extending over the semiconductor substrate,” “a plurality of first trenches in the dielectric layer, each first trench being elongated along a first direction and having a first shape in cross section along a plane that is perpendicular to the first direction,” “a plurality of second trenches in the dielectric layer, each second trench being elongated along the first direction and having a second shape in cross section

along the plane, the second shape being different from the first shape, the first and second trenches arranged in an alternating pattern that alternates from first trench to second trench along a second direction that is perpendicular to the first direction,” and “a plurality of bit lines located in the first trenches.”

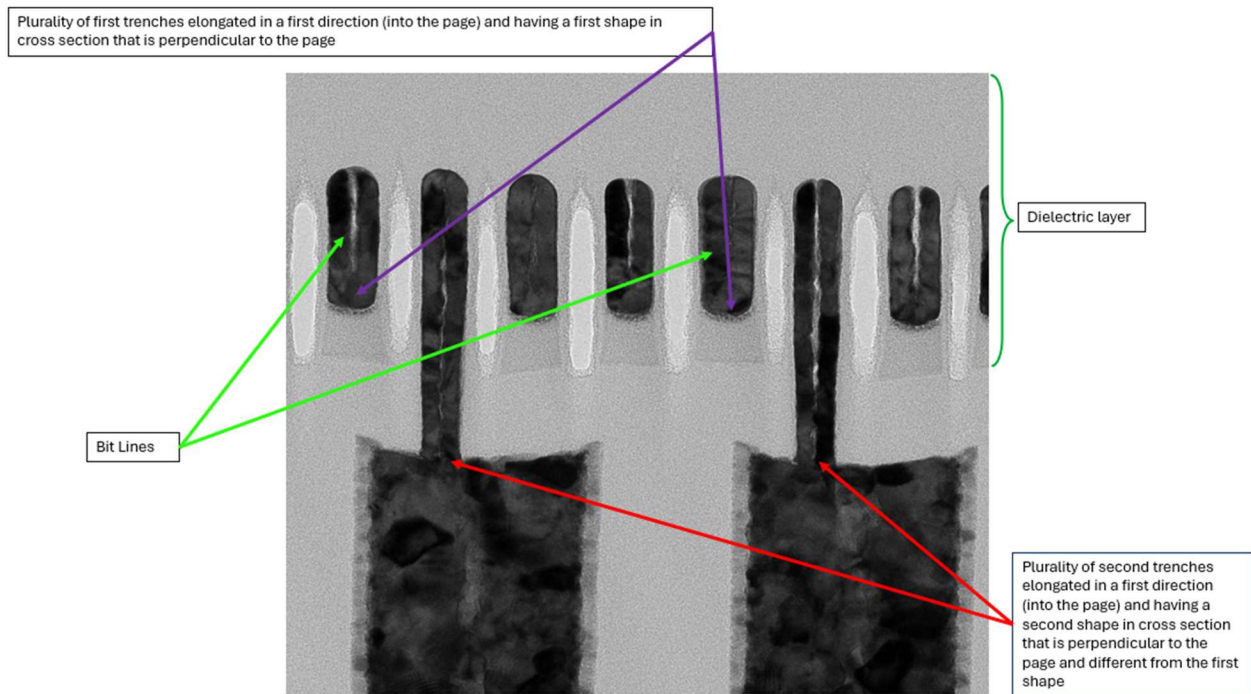

Figure 9 - TEM Image of Micron 7450

For example, the plurality of first trenches (pointed to in purple above) are elongated into the page. The '974 Accused Products also comprise a plurality of second trenches (pointed to in red above). The second trenches have a different height/width from the first trenches. The first and second trenches are arranged in an alternating pattern. Bit lines are located in the plurality of first trenches.

Post-Suit Indirect Infringement (Inducement – 35 U.S.C. § 271(b))

102. In addition and/or in the alternative to its direct infringements, Defendants have indirectly infringed one or more claims of the '974 patent by knowingly and intentionally inducing others, including its subsidiaries, distributors, affiliates, retailers, suppliers, integrators, importers,

customers, and/or consumers, to directly infringe by making, using, offering to sell, selling and/or importing into the United States the '974 Accused Products.

103. Defendants have had knowledge of the '974 patent since the service of the original Complaint in this action. Since receiving notice of its infringements, Defendants actively induced the direct infringements of its subsidiaries, distributors, affiliates, retailers, suppliers, integrators, importers, customers, and/or consumers as set forth under U.S.C. § 271(b). For example, on information and belief, Defendants induce subsidiaries such as Micron Semiconductor Asia PTE and Micron Technology Taiwan Inc. to import the '974 Accused Products into the United States. Such inducements have been committed with the knowledge that the acts induced constitute infringement of the '974 patent. On information and belief, Defendants intended to cause and took affirmative steps to induce infringement by, among other things, creating and disseminating advertisements and instructive materials that promote the infringing use of the '974 Accused Products; creating and/or maintaining established distribution channels for the '974 Accused Products into and within the United States; manufacturing the '974 Accused Products in conformity with U.S. laws and regulations; distributing or making available datasheets supporting use of the '974 Accused Products that promote their features, specifications, and applications; providing technical documentation and tools for the '974 Accused Products, such as white papers, brochures, and/or manuals; promoting the incorporation of the '974 Accused Products into end-user products, testing and certifying features related to initializing a dynamic semiconductor memory device of a random access in the '974 Accused Products; and/or by providing technical support and/or related services for these products to purchasers in the United States.

Damages

104. On information and belief, despite having knowledge of the '974 patent and knowledge that it is directly and/or indirectly infringing one or more claims of the '974 patent since the above detailed knowledge, Micron has nevertheless continued its infringing conduct and disregarded an objectively high likelihood of infringement. Micron's infringing activities relative to the '974 patent have been, and continue to be, willful, wanton, malicious, in bad-faith, deliberate, consciously wrongful, flagrant, and an egregious case of misconduct beyond typical infringement such that Palisade is entitled to enhanced damages under 35 U.S.C. § 284 up to three times the amount found or assessed.

105. Palisade has been damaged as a result of Micron's infringing conduct described in this Court. Micron is, thus, liable to Palisade in an amount that adequately compensates Palisade for Micron's infringements, which, by law, cannot be less than a reasonable royalty, together with interest and costs as fixed by this Court under 35 U.S.C. § 284.

CONCLUSION

106. Palisade is entitled to recover from Defendants the damages sustained by Palisade as a result of Defendants' wrongful acts, and willful infringements, in an amount subject to proof at trial, which, by law, cannot be less than a reasonable royalty, together with interest and costs as fixed by this Court.

107. Palisade has incurred and will incur attorneys' fees, costs, and expenses in the prosecution of this action. The circumstances of this dispute may give rise to an exceptional case within the meaning of 35 U.S.C. § 285, and Palisade is entitled to recover its reasonable and necessary attorneys' fees, costs, and expenses.

JURY DEMAND

108. Palisade hereby requests a trial by jury pursuant to Rule 38 of the Federal Rules of Civil Procedure.

PRAYER FOR RELIEF

109. Palisade respectfully requests that the Court find in its favor and against Defendants, and that the Court grant Palisade the following relief:

- (i) A judgment that one or more claims of the Asserted Patents have been infringed, either literally and/or under the doctrine of equivalents, by Defendants;
- (ii) A judgment that one or more claims of the Asserted Patents have been willfully infringed, either literally and/or under the doctrine of equivalents, by Defendants;
- (iii) A judgment that Defendants account for and pay to Plaintiff all damages and costs incurred by Plaintiff because of Defendants' infringing activities and other conduct complained of herein, including an accounting for any sales or damages not presented at trial;
- (iv) A judgment that Defendants account for and pay to Plaintiff a reasonable, ongoing, post judgment royalty because of Defendants' infringing activities, including continuing infringing activities, and other conduct complained of herein;
- (v) A judgment that Plaintiff be granted pre-judgment and post judgment interest on the damages caused by Defendants' infringing activities and other conduct complained of herein;
- (vi) A judgment that this case is exceptional under the provisions of 35 U.S.C. § 285 and award enhanced damages; and
- (vii) Such other and further relief as the Court deems just and equitable.

Dated: December 19, 2024

Respectfully submitted,

/s/ Patrick J. Conroy

Patrick J. Conroy

Texas Bar No. 24012448

T. William Kennedy Jr.

Texas Bar No. 24055771

Ryan P. Griffin

Texas Bar No. 24053687

Jonathan H. Rastegar

Texas Bar No. 24064043

David T. DeZern

Texas Bar No. 24059677

Nelson Bumgardner Conroy PC

2727 N. Harwood St., Suite 250

Dallas, TX 75201

Tel: (214) 446-4950

pat@nelbum.com

bill@nelbum.com

ryan@nelbum.com

jon@nelbum.com

david@nelbum.com

Mark D. Siegmund

Texas Bar No. 24117055

William D. Ellerman

Texas Bar No. 24007151

CHERRY JOHNSON SIEGMUND

JAMES PLLC

Bridgeview Center

7901 Fish Pond Road, 2nd Floor

Waco, Texas 76710

Telephone: (254) 732-2242

Facsimile: (866) 627-3509

msiegmund@cjsjlaw.com

wellerman@cjsjlaw.com

Attorneys for Plaintiff

Palisade Technologies, LLP

CERTIFICATE OF SERVICE

Pursuant to the Federal Rules of Civil Procedure, I hereby certify that all counsel of record who have appeared in this case are being served on this day of December 19, 2024, with a copy of the foregoing via CM/ECF Filing.

/s/ Patrick J. Conroy