



LGEUS is a wholly-owned subsidiary of LGE and has regular and established places of business within this District at 2153-2155 Eagle Parkway, Fort Worth, Texas 76177 and 14901 Beach Street, Fort Worth, Texas 76177. LGEUS may be served with process through its Texas registered agent, United States Corporation Co., 211 East 7th Street, Suite 620, Austin, Texas 78701.

### **JURISDICTION**

4. This is an action for patent infringement arising under the patent laws of the United States, 35 U.S.C. §§ 1, *et seq.* This Court has jurisdiction over this action pursuant to 28 U.S.C. §§ 1331, 1332, 1338 and 1367.

5. This Court has specific and personal jurisdiction over the Defendants consistent with the requirements of the Due Process Clause of the United States Constitution and the Texas Long Arm Statute. Upon information and belief, the Defendants have sufficient minimum contacts with the forum because each Defendant transacts substantial business in the State of Texas and in this Judicial District. Further, each Defendant has, directly or through subsidiaries or intermediaries, committed and continues to commit acts of patent infringement in the State of Texas and in this Judicial District as alleged in this Complaint, as alleged more particularly below.

6. Venue is proper in this Judicial District pursuant to 28 U.S.C. §§ 1400(b) and 1391(b) and (c) because each Defendant is subject to personal jurisdiction in this Judicial District, has committed acts of patent infringement in this Judicial District, and has a regular and established place of business in this Judicial District. Each Defendant, through its own acts and/or through the acts of each other Defendant, makes, uses, sells, offers to sell, and/or imports infringing products within this Judicial District, regularly does and solicits business in this Judicial District, and has the requisite minimum contacts with this Judicial District such that this venue is a fair and reasonable one. LGEUS has maintained regular and established places of business within this

District at 2153-2155 Eagle Parkway, Fort Worth, Texas 76177 and 14901 Beach Street, Fort Worth, Texas 76177. Further, venue is proper in this Judicial District because LGE is a foreign corporation formed under the laws of the Republic of Korea, with a principal place of business in the Republic of Korea. 28 U.S.C. § 1391(c)(3) provides that “a defendant not resident in the United States may be sued in any judicial district, and the joinder of such a defendant shall be disregarded in determining where the action may be brought with respect to other defendants.” Further, upon information and belief, the Defendants have admitted or not contested proper venue in this Judicial District in other patent infringement actions.

### **PATENTS-IN-SUIT**

7. On January 18, 2005, the United States Patent and Trademark Office duly and legally issued U.S. Patent No. 6,845,128 (the “’128 Patent”) entitled “Video-Emphasis Encoding Apparatus and Decoding Apparatus and Method of Video-Emphasis Encoding and Decoding.” A true and correct copy of the ’128 Patent is available at:

<https://patentimages.storage.googleapis.com/fe/9a/1d/5106adc1e2a8f2/US6845128.pdf>.

8. On January 3, 2012, the United States Patent and Trademark Office duly and legally issued U.S. Patent No. 8,090,025 (the “’025 Patent”) entitled “Moving-Picture Coding Apparatus Method and Program, and Moving-Picture Decoding Apparatus, Method and Program.” On October 4, 2022, the United States Patent and Trademark Office duly and legally issued a Certificate of Correction to the ’025 Patent. A true and correct copy of the ’025 Patent is available at: <https://image-ppubs.uspto.gov/dirsearch-public/print/downloadPdf/8090025>.

9. On May 29, 2018, the United States Patent and Trademark Office duly and legally issued U.S. Patent No. 9,986,303 (the “’303 Patent”) entitled “Video Image Coding Data Transmitter, Video Image Coding Data Transmission Method, Video Image Coding Data

Receiver, and Video Image Coding Data Transmission and Reception System.” A true and correct copy of the ’303 Patent is available at <https://image-ppubs.uspto.gov/dirsearch-public/print/downloadPdf/9986303>.

10. On February 26, 2019, the United States Patent and Trademark Office duly and legally issued U. S. Patent No. 10,218,995 entitled “Moving Picture Encoding System, Moving Picture Encoding Method, Moving Picture Encoding Program, Moving Picture Decoding System, Moving Picture Decoding Method, Moving Picture Decoding Program, Moving Picture Reencoding System, Moving Picture Reencoding Method, Moving Picture Reencoding Program.” A true and correct copy of the ’995 Patent is available at: <https://image-ppubs.uspto.gov/dirsearch-public/print/downloadPdf/10218995>.

11. ACT is the sole and exclusive owner of all right, title, and interest in the ’128 Patent, the ’025 Patent, the ’303 Patent, and the ’995 Patent (collectively, the “Patents-in-Suit”) and holds the exclusive right to take all actions necessary to enforce its rights to the Patents-in-Suit, including the filing of this patent infringement lawsuit. ACT also has the right to recover all damages for past, present, and future infringement of the Patents-in-Suit.

### **FACTUAL ALLEGATIONS**

12. The Patents-in-Suit generally relate to systems and methods for coding and decoding data efficiently.

13. The ’128 Patent generally relates to emphasis processing for the encoding and decoding of video bitstreams. The technology described in the ’128 Patent was developed by Kenji Sugiyama of Victor Company of Japan, Ltd.

14. The '025 Patent generally relates to efficient methods of video encoding and decoding using motion compensation. The technology described in the '025 Patent was developed by Satoru Sakazume of Victor Company of Japan, Ltd.

15. The '303 Patent generally relates to technology that allows for the efficient transmission and reception of two different resolutions of video data. The technology described in the '303 Patent was developed by Hideki Takehara and Motoharu Ueda of JVC Kenwood Corporation.

16. The '995 Patent generally relates to hierarchical encoding that implements a process for super-resolution enlargement of video signals. The technology described in the '995 Patent was developed by Satoru Sakazume of JVC Kenwood Corporation.

17. Defendants have infringed and continue to infringe one or more of the Patents-in-Suit by making, using, selling, offering to sell, and/or importing, and by actively inducing others to make, use, sell, offer to sell, and/or import products, including televisions, laptops, and chipsets thereof, that implement the technology claimed by the Patents-in-Suit. For example, the Accused Products include, but are not limited to, LG's Televisions and Laptop Computers as described below.

18. LG has had actual notice of the Asserted Patents, at least as of the filing date of this complaint.

19. ACT has at all times complied with the marking provisions of 35 U.S.C. § 287 with respect to the Asserted Patents.

**COUNT I**  
**(Infringement of the '128 Patent)**

20. Paragraphs 1 through 19 are incorporated by reference as if fully set forth herein.

21. ACT has not licensed or otherwise authorized Defendants to make, use, offer for sale, sell, or import any products that embody the inventions of the '128 Patent.

22. Defendants have and continue to directly infringe the '128 Patent, either literally or under the doctrine of equivalents, without authority and in violation of 35 U.S.C. § 271, by making, using, offering to sell, selling, and/or importing into the United States products that satisfy each and every limitation of one or more claims of the '128 Patent. Such products include each device made, used, offered for sale, sold, and/or imported into the United States containing NVIDIA processors using the “Turing” or “Ampere” architectures (the “'128 Accused Products”), including, but not limited to, the LG gram 16”, LG gram 17”, LG Ultra PC 17”, and the LG UltraGear 17G90Q, which are video-emphasis encoding apparatuses that apply emphasis processing to an input video signal to obtain a video bitstream, include an emphasis-level setter for setting an emphasis level to the input video signal in accordance with at least one factor among control data carried by the input video signal, a picture state detected from the input video signal and encoding conditions for the input video signal; an emphasisizer for applying the emphasis processing to the input video signal at the emphasis level to obtain an emphasized video signal; an encoder for encoding the emphasized video signal to obtain a video bitstream; and a multiplexer for multiplexing the video bitstream and data on the emphasis level.

23. For example, Defendants have and continue to directly infringe at least claim 1 of the '128 Patent by making, using, offering to sell, selling, and/or importing into the United States products that include NVIDIA processors using the “Turing” or “Ampere” architectures that include Emphasis Level Mapping functionality.

24. For example, the '128 Accused Products include an emphasis-level setter for setting an emphasis level to the input video signal in accordance with at least one factor among control

data carried by the input signal, a picture state detected from the input video signal and encoding conditions for the input video signal:

### 3. NVENC BLOCK DIAGRAM

Apart from the rate control and picture type decision, NVENC can perform all tasks that are a critical part of the end-to-end H.264 and H.265 encoding. The rate control algorithm is implemented in GPU's firmware and controlled via the driver. From the application's perspective, rate control is a hardware function controlled via the parameters exposed in the NVENC APIs. The hardware also provides capability to use external motion estimation engine and custom quantization parameter maps (for ROI "region of interest" encoding). The region of interest encoding has been made available using the "QP delta map" where in the Quantization parameters derived from the Rate Control algorithm can be tweaked using the QP delta map.

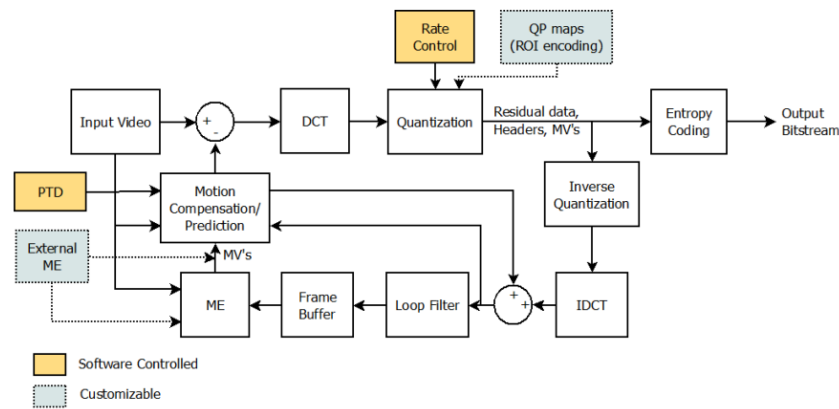

Source: [https://developer.download.nvidia.com/compute/nvenc/v5.0\\_beta/NVENC\\_DA-06209-001\\_v06.pdf](https://developer.download.nvidia.com/compute/nvenc/v5.0_beta/NVENC_DA-06209-001_v06.pdf)

25. The '128 Accused Products include an emphasis for applying emphasis processing to the input video signal at the emphasis level to obtain an emphasized video signal. The quantization block obtains adjusted QP values (*i.e.*, emphasis level data) and uses those to quantize the input video signal from the DCT block:

## 8.8. Emphasis MAP

The emphasis map feature in NVENCODE API provides a way to specify regions in the frame to be encoded at varying levels of quality, at macroblock-level granularity. Depending upon the actual emphasis level for each macroblock, the encoder applies an adjustment to the quantization parameter used to encode that macroblock. The value of this adjustment depends on the following factors:

- ▶ Absolute value of the QP as decided by the rate control algorithm, depending upon the rate control constraints. In general, for a given emphasis level, higher the QP determined by the rate control, higher the (negative) adjustment.
- ▶ Emphasis level value for the macroblock.

**Note:** The QP adjustment is performed after the rate control algorithm has run. Therefore, there is a possibility of VBV/rate violations when using this feature.

Emphasis level map is useful when the client has prior knowledge of the image complexity (e.g. NVFBC's Classification Map feature) and encoding those high-complexity areas at higher quality (lower QP) is important, even at the possible cost of violating bitrate/VBV buffer size constraints. This feature is not supported when AQ (Spatial/Temporal) is enabled.

Follow these steps to enable the feature.

1. Query availability of the feature using `NvEncGetEncodeCaps` API and checking for `NV_ENC_CAPS_SUPPORT_EMPHASIS_LEVEL_MAP`.
2. Set `NV_ENC_RC_PARAMS::qpMapMode = NV_ENC_QP_MAP_EMPHASIS`.
3. Fill up the `NV_ENC_PIC_PARAMS::qpDeltaMap` (which is a signed byte array containing value per macroblock in raster scan order for the current picture) with a value from enum `NV_ENC_EMPHASIS_MAP_LEVEL`.

As explained above, higher values of `NV_ENC_EMPHASIS_MAP_LEVEL` imply higher (negative) adjustment made to the QP to *emphasize* quality of that macroblock. The user can choose higher emphasis level for the regions (s)he wants to encode with a higher quality.

Source: [https://docs.nvidia.com/video-technologies/video-codec-sdk/pdf/NVENC\\_VideoEncoder\\_API\\_ProgGuide.pdf](https://docs.nvidia.com/video-technologies/video-codec-sdk/pdf/NVENC_VideoEncoder_API_ProgGuide.pdf)

26. The '128 Accused Products include an encoder for encoding the emphasized video signal to obtain a video bitstream, such as an H.264/HEVC/AV1 compliant video bit stream.

27. The '128 Accused Products include a multiplexer for multiplexing the video bitstream and data on the emphasis level. The data on the emphasis level, the field "delta QP," is multiplexed into the header of the bitstream packets.

28. LG has indirectly infringed and continues to indirectly infringe one or more claims of the '128 Patent, as provided by 35 U.S.C. § 271(b), by inducing infringement by others, such as LG's customers and end-users, in this District and elsewhere in the United States. For example, LG's customers and end-users directly infringe, either literally or under the doctrine of equivalents, through their use of the inventions claimed in the '128 Patent. LG induces this direct infringement through its affirmative acts of manufacturing, selling, distributing, and/or otherwise making

available the '128 Accused Products, and providing instructions, documentation, and other information to customers and end-users suggesting that they use the '128 Accused Products in an infringing manner, including technical support, marketing, product manuals, advertisements, and online documentation. Because of LG's inducement, LG's customers and end-users use the '128 Accused Products in a way LG intends and they directly infringe the '128 Patent. LG performs these affirmative acts with knowledge of the '128 Patent and with the intent, or willful blindness, that the induced acts directly infringe the '128 Patent.

29. LG has indirectly infringed and continues to indirectly infringe one or more claims of the '128 Patent, as provided by 35 U.S.C. § 271(c), by contributing to direct infringement by others, such as customers and end-users, in this District and elsewhere in the United States. LG's affirmative acts of selling and offering to sell the '128 Accused Products in this District and elsewhere in the United States and causing the '128 Accused Products to be manufactured, used, sold, and offered for sale contribute to others' use and manufacture of the '128 Accused Products, such that the '128 Patent is directly infringed by others. The accused components within the '128 Accused Products are material to the invention of the '128 Patent, are not staple articles or commodities of commerce, have no substantial non-infringing uses, and are known by LG to be especially made or adapted for use in the infringement of the '128 Patent. LG performs these affirmative acts with knowledge of the '128 Patent and with intent, or willful blindness, that they cause the direct infringement of the '128 Patent.

30. ACT has suffered damages as a result of Defendants' direct and indirect infringement of the '128 Patent in an amount to be proved at trial.

**COUNT II**  
**(Infringement of the '025 Patent)**

31. Paragraphs 1 through 19 are incorporated by reference as if fully set forth herein.

32. ACT has not licensed or otherwise authorized Defendants to make, use, offer for sale, sell, or import any products that embody the inventions of the '025 Patent.

33. Defendants have and continue to directly infringe the '025 Patent, either literally or under the doctrine of equivalents, without authority and in violation of 35 U.S.C. § 271, by making, using, offering to sell, selling, and/or importing into the United States products that satisfy each and every limitation of one or more claims of the '025 Patent. Such products include at least LG Televisions compliant with the AV1 and/or SVT-AV1 Standards including, but not limited to, the LG Z2, LG G2, LG C2, LG B2, LG A2, LG QNED99 2022, LG QNED90 2022, LG QNED85 2022, LG QNED80 2022, LG NANO80 2022, LG NANO75 2022, LG UQ90, LG UQ80, LG UQ75, LG UQ70, LG Z1, LG G1, LG C1, LG B1, LG A1, LG QNED99, LG QNED95, LG QNED90, LG NANO99 2021, LG NANO90 2021, LG NANO80 2021, LG NANO75, LG UP80, LG RX, LG ZX, LG WX, LG GX, LG CX, LG BX, LG NANO99, LG NANO90, LG NANO85, LG UN85, and the LG UN73 (the '025 Accused Products), which practice a moving-picture decoding method comprising the steps of: demultiplexing coded data from an input signal based on a specific syntax structure, the input signal being obtained by multiplexing a coded bitstream obtained by predictive coding, border motion-vector data and post-quantization data obtained by quantization in the predictive coding, the coded bitstream obtained by producing and encoding a residual picture that is a residual signal between a picture to be coded that is an input moving-picture video signal to be subjected to coding and a predictive picture produced from a reference picture that is a local decoded video signal for each of a plurality of rectangular zones, each composed of a specific number of pixels, into which a video area of the moving-picture video signal is divided, obtaining a boundary condition of each of a plurality of borders between the rectangular zones and another plurality of rectangular zones adjacent to the rectangular zones,

finding a border, of the reference picture, having a boundary condition that matches the boundary condition, by motion-vector search in the reference picture, and generating the border motion-vector data that is data on a motion vector from a border of the rectangular zone in the picture to be coded to the border of the reference picture thus found, defining a boundary condition of a border that corresponds to the border motion-vector data, from the reference picture based on the border motion-vector data, and generating an estimated video signal in each rectangular zone in the picture to be coded, that satisfies Poisson's Equation, thus producing the predictive picture; performing entropy decoding to the data thus demultiplexed to generate, at least, the post-quantization data, the border motion-vector data and parameter data required for constructing a specific syntax structure; performing inverse-quantization to the post-quantization data to generate post-quantization orthogonal transform coefficients data; performing inverse-orthogonal transform to the post-quantization orthogonal transform coefficients data to produce a decoded residual picture of one video area; defining a boundary condition of a border that corresponds to the border motion-vector data, from the reference picture based on the border motion-vector data, and generate an estimated video signal in each rectangular zone in the picture to be coded, that satisfies Poisson's Equation, thus producing a first predictive picture; combining the first predictive picture and the decoded residual picture to generate a decoded moving-picture signal; and storing the decoded moving-picture signal for at least one picture as a reference picture.

34. The '025 Accused Products infringe at least claim 10 of the '025 Patent because they demultiplex coded data from an input signal based on a specific syntax structure, the input signal being obtained by predictive coding, border motion-vector data and post-quantization data obtained by quantization in the predictive coding:

Supported Video Codecs		
Extension	Codec	
asf wmv	Video	VC-1 Advanced Profile (except for WMVA), VC-1 Simple and Main Profiles
	Audio	WMA Standard (except for WMA v1/WMA Speech)
avi	Video	Xvid (GMC is not supported), H.264/AVC, Motion Jpeg, MPEG-4
	Audio	MPEG-1 Layer I, II, MPEG-1 Layer III (MP3), Dolby Digital, LPCM, ADPCM
mp4 m4v mov	Video	H.264/AVC, MPEG-4, HEVC, AV1, VVC
	Audio	Dolby Digital, Dolby Digital Plus, AAC, MPEG-1 Layer III (MP3), Dolby AC-4
3gp 3g2	Video	H.264/AVC, MPEG-4
	Audio	AAC, AMR-NB, AMR-WB
mkv	Video	MPEG-2, MPEG-4, H.264/AVC, VP8, VP9, HEVC, AV1
	Audio	Dolby Digital, Dolby Digital Plus, AAC, PCM, MPEG-1 Layer I, II, MPEG-1 Layer III (MP3)

Source: <https://www.lg.com/us/support/product/lg-43UQ7590PUB.AUS> (English User Guide)

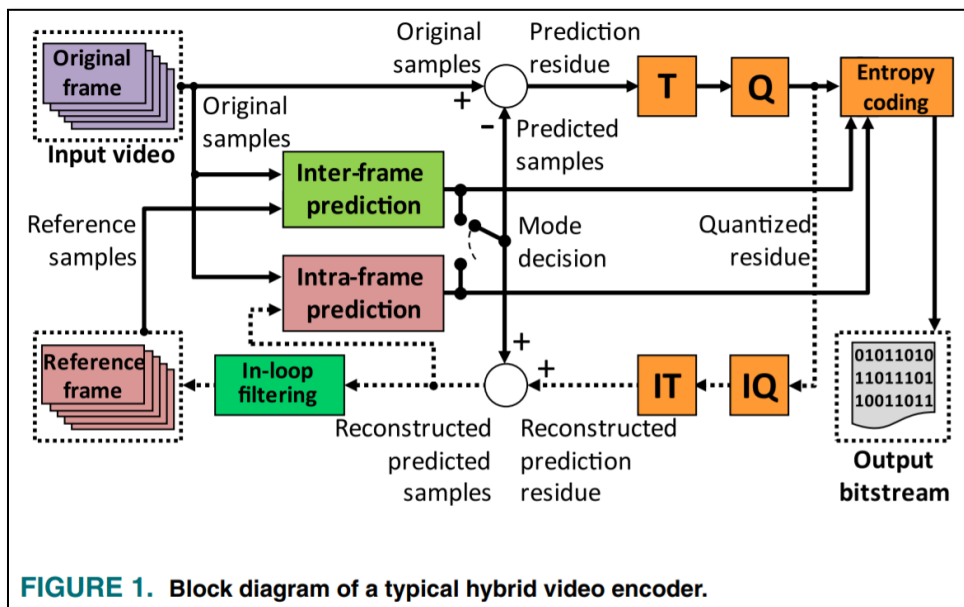

Source: <https://ieeexplore.ieee.org/ielx7/8784029/9314963/09536216.pdf>

35. The coded bitstream in the '025 Accused Products is obtained by producing and encoding a residual picture that is a residual signal between a picture to be coded that is an input

moving-picture video signal to be subjected to coding and a predictive picture produced from a reference picture that is a local decoded video signal for each of a plurality of rectangular zones, each composed of a specific number of pixels, into which a video area of the moving-picture video signal is divided:

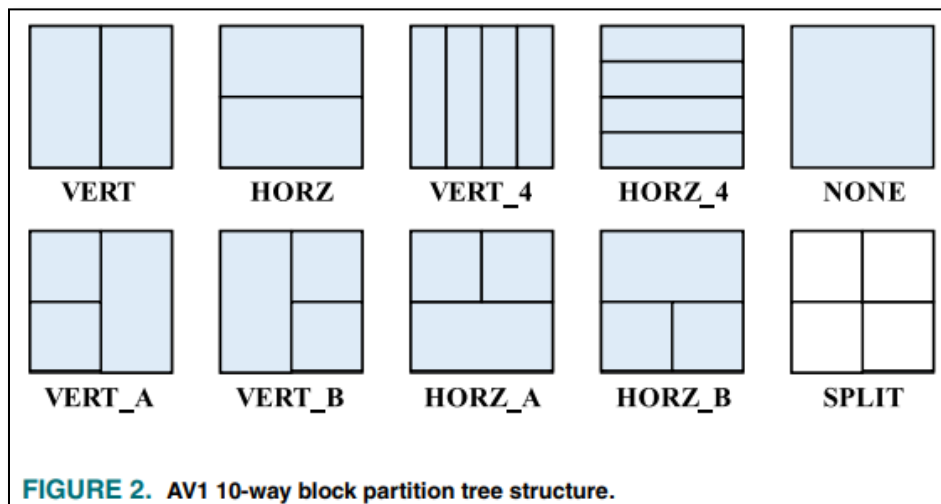
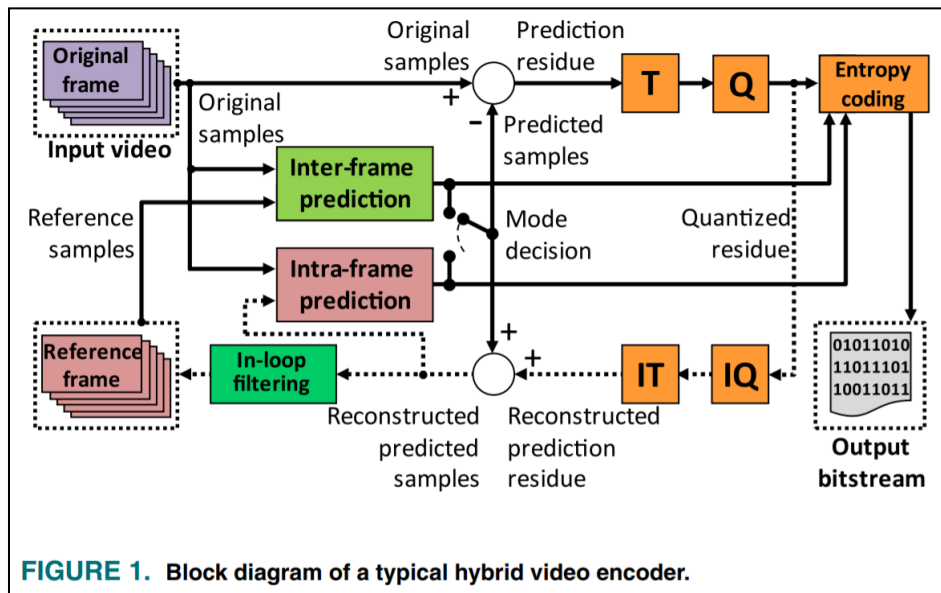

Source: <https://ieeexplore.ieee.org/ielx7/8784029/9314963/09536216.pdf>

36. The '025 Accused Products obtain a boundary condition of each of a plurality of borders between the rectangular zones and another plurality of rectangular zones adjacent to the

rectangular zones, find a border, of the reference picture, having a boundary condition that matches the boundary condition, by motion-vector search in the reference picture, and generate the border motion-vector data that is data on a motion vector from a border of the rectangular zone in the picture to be coded to the border of the reference picture thus found, by using the motion estimation process for a block and locating the pixel values at the border between the current block and the neighboring block. Border motion-vector data is generated when a boundary condition in the reference frame matches the boundary condition in the current frame, and the block motion estimation algorithm uses a comparison of these boundary conditions to generate motion vectors:

### **C. INTER PREDICTION**

In inter-frame prediction, the block is predicted from samples belonging to previously encoded frames. Both AV1 and VVC use Motion Estimation (ME) and Motion Compensation (MC) algorithms in addition to motion vector prediction tools to reduce the amount of lateral data. Both video formats allow block sizes from  $128 \times 128$  to  $4 \times 4$  in inter prediction. VVC and AV1 can evaluate 28 and 22 block sizes, respectively, in function of the difference between their frame partition processes.

Source: <https://ieeexplore.ieee.org/document/8296419>

37. The '025 Accused Products define a boundary condition of a border that corresponds to the border motion-vector data, from the reference picture based on the border motion-vector data, and generate an estimated video signal in each rectangular zone in the picture to be coded, that satisfies Poisson's Equation, thus producing the predictive picture. For example, the estimated signal generation process in AV1 and/or SVT-AV1 satisfies Poisson's Equation via the use of smoothing algorithms in Overlapped Block Motion Compensation ("OMBC"). The process involves finding predicted pixels of a block in steady state (that minimizes the residual). The estimated video signal is used to produce a predictive picture (*e.g.*, predictive sample):

(see Fig.2(b) for a 32-tap example) and formulated as

$$w_K(k) = \frac{1}{2} \sin\left(\frac{\pi}{2K}\left(k + \frac{1}{2}\right)\right) + \frac{1}{2}, k = 0, 1, \dots, K - 1 \quad (1)$$

is applied to every column (see Fig.2(a)) of the overlapping region, and updates  $p_{obmc}(x, y)$  as

$$w_{\frac{N}{2}}(y)p_{obmc}(x, y) + (1 - w_{\frac{N}{2}}(y))p_i(x, y). \quad (2)$$

This filter approximately averages the predictions at the common edge, and gradually reduces the influence of the new prediction  $p_i$  until it vanishes at the mid-line of the current block, because the conventional block matching  $p_0$  often works best for pixels in the center. Then we move on to the second stage to exploit predictors of the left neighbors. Likewise, 1-D filtering will be performed on top of the  $p_{obmc}(x, y)$  updated after the first phase: (1) the overlapping region for each left neighbors will be on the right side of the common edge, e.g. the shaded area for  $p_4$  in Fig.1(b); (2) we apply the 1-D filter in the horizontal direction, i.e.

$$p_{obmc}(x, y) := w_{\frac{M}{2}}(x)p_{obmc}(x, y) + (1 - w_{\frac{M}{2}}(x))p_i(x, y). \quad (3)$$

Source: <https://ieeexplore.ieee.org/document/8296419>

### Overlapped Block Motion Compensation

- Block motion compensation only uses the assigned MV
- OBMC creates secondary predictions from neighbors' MVs, and blend them with BMC to mitigate the effect of discontinued motion field
- AV1 OBMC is a 2-sided causal overlapped predictor
  - Overlapping is operated in the top/left halves
  - Uses predefined 1-D smooth filters
  - Same memory bandwidth as compound pred.

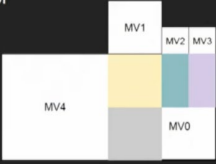

Source: <https://wenxiaoming.github.io/2019/03/02/The-overview-of-AV1-coding/>

38. The '025 Accused Products perform entropy decoding to the data thus demultiplexed to generate, at least, the post-quantization data, the border motion-vector data and parameter data required for constructing a specific syntax structure:

#### E. ENTROPY CODING

The entropy coding processes the symbols (quantized coefficients and lateral data) to reduce their statistical redundancy by applying lossless algorithms.

AV1 uses a symbol-to-symbol adaptive multi-symbol arithmetic coder with the probability being updated every new symbol. Each syntax element in AV1 is a member of an alphabet of  $N$  elements, and a context consists of a set of  $N$  probabilities together with a small count to facilitate fast early adaptation [2].

#### D. TRANSFORMS AND QUANTIZATION

The prediction error, or the residues, between the intra and inter prediction and the original blocks are processed by the transform module (T module, in Fig. 1), which converts the values from the spatial domain to the frequency domain. Then, the quantization step (Q module in Fig. 1) is applied to the transformed coefficients to attenuate or eliminate values associated with spectral components that are not perceptually relevant for the human visual system.

Source: <https://ieeexplore.ieee.org/ielx7/8784029/9314963/09536216.pdf>

39. The '025 Accused Products perform inverse-quantization to the post-quantization data to generate post-quantization orthogonal transform coefficients data, and perform inverse-orthogonal transform to the post-quantization orthogonal transform coefficients data to produce a decoded residual picture of one video area.

40. The '025 Accused Products define a boundary condition of a border that corresponds to the motion-vector data, from the reference picture based on the border motion-vector data, and generate an estimated video signal in each rectangular zone in the picture to be coded, that satisfied Poisson's Equation, thus producing a first predictive picture.

41. The '025 Accused Products combine the first predictive picture and the decoded residual picture to generate a decoded moving-picture signal:

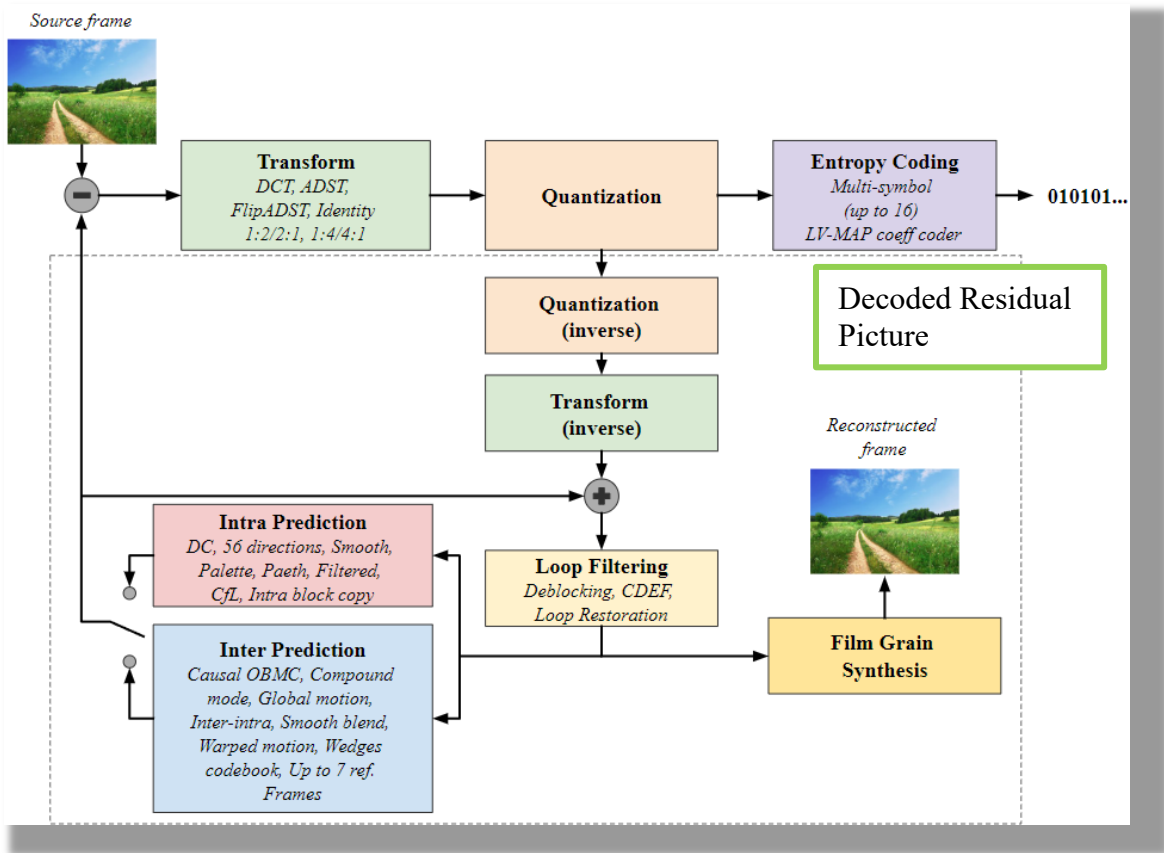

Source: <https://wenxiaoming.github.io/2019/03/02/The-overview-of-AV1-coding/>

## 7.14. Loop filter process

### 7.14.1. General

Input to this process is the array CurrFrame of reconstructed samples.

Output from this process is a modified array CurrFrame containing deblocked samples.

Source: <https://aomediacodec.github.io/av1-spec/av1-spec.pdf>, Page 307

42. The '025 Accused Products store the decoded moving-picture signal for at least one picture as a reference picture, by updating the set of reference frames.

43. Defendants have and continue to directly infringe at least claim 10 of the '025 Patent by making, using, offering to sell, selling, and/or importing into the United States products that implement AV1 and/or SVT-AV1 standards, such as the '025 Accused Products.

44. LG has indirectly infringed and continues to indirectly infringe one or more claims of the '025 Patent, as provided by 35 U.S.C. § 271(b), by inducing infringement by others, such as LG's customers and end-users, in this District and elsewhere in the United States. For example, LG's customers and end-users directly infringe, either literally or under the doctrine of equivalents, through their use of the inventions claimed in the '025 Patent. LG induces this direct infringement through its affirmative acts of manufacturing, selling, distributing, and/or otherwise making available the '025 Accused Products, and providing instructions, documentation, and other information to customers and end-users suggesting that they use the '025 Accused Products in an infringing manner, including technical support, marketing, product manuals, advertisements, and online documentation. Because of LG's inducement, LG's customers and end-users use the '025 Accused Products in a way LG intends and they directly infringe the '025 Patent. LG performs these affirmative acts with knowledge of the '025 Patent and with the intent, or willful blindness, that the induced acts directly infringe the '025 Patent.

45. LG has indirectly infringed and continues to indirectly infringe one or more claims of the '025 Patent, as provided by 35 U.S.C. § 271(c), by contributing to direct infringement by others, such as customers and end-users, in this District and elsewhere in the United States. LG's affirmative acts of selling and offering to sell the '025 Accused Products in this District and elsewhere in the United States and causing the '025 Accused Products to be manufactured, used, sold, and offered for sale contribute to others' use and manufacture of the Accused Products, such that the '025 Patent is directly infringed by others. The accused components within the Accused

Products including, but not limited to, software manufactured by LG, are material to the invention of the '025 Patent, are not staple articles or commodities of commerce, have no substantial non-infringing uses, and are known by LG to be especially made or adapted for use in the infringement of the '025 Patent. LG performs these affirmative acts with knowledge of the '025 Patent and with intent, or willful blindness, that they cause the direct infringement of the '025 Patent.

46. ACT has suffered damages as a result of Defendants' direct and indirect infringement of the '025 Patent in an amount to be proved at trial.

**COUNT III**  
**(Infringement of the '303 Patent)**

47. Paragraphs 1 through 19 are incorporated by reference as if fully set forth herein.

48. ACT has not licensed or otherwise authorized Defendants to make, use, offer for sale, sell, or import any products that embody the inventions of the '303 Patent.

49. Defendants have and continue to directly infringe the '303 Patent, either literally or under the doctrine of equivalents, without authority and in violation of 35 U.S.C. § 271, by making, using, offering to sell, selling, and/or importing into the United States products that satisfy each and every limitation of one or more claims of the '303 Patent. Such products include at least LG Televisions compliant with the AV1 and/or SVT-AV1 Standards including, but not limited to, the LG Z2, LG G2, LG C2, LG B2, LG A2, LG QNED99 2022, LG QNED90 2022, LG QNED85 2022, LG QNED80 2022, LG NANO80 2022, LG NANO75 2022, LG UQ90, LG UQ80, LG UQ75, LG UQ70, LG Z1, LG G1, LG C1, LG B1, LG A1, LG QNED99, LG QNED95, LG QNED90, LG NANO99 2021, LG NANO90 2021, LG NANO80 2021, LG NANO75, LG UP80, LG RX, LG ZX, LG WX, LG GX, LG CX, LG BX, LG NANO99, LG NANO90, LG NANO85, LG UN85, and the LG UN73 (the '303 Accused Products) which include a video image coding data receiver comprising a processor and a memory unit having instructions stored which, when

executed by the processor, cause the processor to perform operations comprising receiving basic video image coding data; decoding the received basic video image coding data so as to reproduce a video image; receiving supplementary video image coding data including a supplementary hierarchical picture whose coding order and display order are earlier by a factor of a group of pictures including an intra coded picture and a plurality of inter prediction coded pictures than those of a basic hierarchical picture included in the basic video image coding data, a basic hierarchy and a supplementary hierarchy being set in units of the group of pictures; acquiring basic video image coding data received before supplementary video image coding data that has been received at the moment; and reconstructing video image coding data from the basic video image coding data and the supplementary video image coding data.

50. For example, Defendants have and continue to directly infringe at least claim 1 of the '303 Patent by making, using, offering to sell, selling, and/or importing into the United States televisions that are compliant with the AV1 and/or SVT-AV1 Standards, such as the '303 Accused Products.

51. The '303 Accused Products are video image coding data receivers that include a processor and a memory.

52. The '303 Accused Products are configured to receive and decode basic video image coding data, such as a bitstream of video at 720p resolution, and to decode that data to reproduce a video image.

53. The '303 Accused Products are configured to receive supplementary video image coding data including a supplementary hierarchical picture, such as a bitstream of video at a 1080p resolution.

54. The supplementary hierarchical picture's coding order and display order are earlier than those of a basic hierarchical picture by a factor of a group of pictures. For example, AV1 uses an S frame to switch to lower or higher frame rates:

**Switch Frame**

An inter frame that can be used as a point to switch between sequences. Switch frames overwrite all the reference frames without forcing the use of intra coding. The intention is to allow a streaming use case where videos can be encoded in small chunks (say of 1 second duration), each starting with a switch frame. If the available bandwidth drops, the server can start sending chunks from a lower bitrate encoding instead. When this happens the inter prediction uses the existing higher quality reference frames to decode the switch frame. This approach allows a bitrate switch without the cost of a full key frame.

Source: <https://aomediacodec.github.io/av1-spec/av1-spec.pdf>, at page 5

55. Each Group of Pictures includes an intra coded picture and a plurality of inter prediction coded pictures:

**frame\_type** specifies the type of the frame:

frame_type	Name of frame_type
0	KEY_FRAME
1	INTER_FRAME
2	INTRA_ONLY_FRAME
3	SWITCH_FRAME

Source: <https://aomediacodec.github.io/av1-spec/av1-spec.pdf>, at page 150

56. The supplementary hierarchical picture's coding order and display order are earlier than the basic hierarchical picture because the received data is stored in a buffer before decoding:

**PresentationTimes[ i ]** is an array corresponding to the BufferPool [ i ] that holds the last presentation time for the decoded frame that is kept in the BufferPool [ i ].

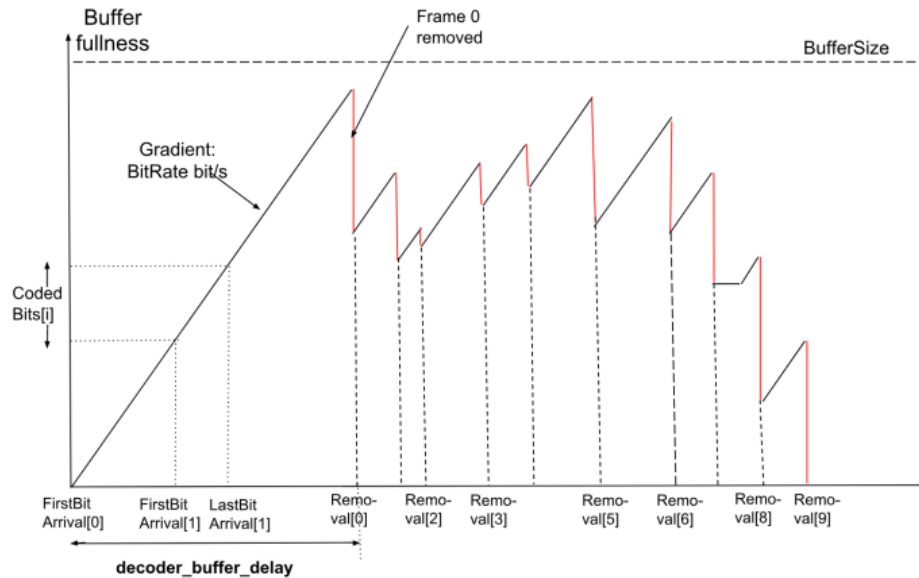

Example of how the coded frame buffer fullness varies as data arrives from the stream, and is subsequently removed for decoding. Relevant timing points and values are indicated.

Source: <https://aomediacodec.github.io/av1-spec/av1-spec.pdf>, at page 654-55

Therefore, when an S frame switches from basic to supplementary video data, basic hierarchical pictures are still decoded and displayed out of the buffer.

57. The '303 Accused Products are configured to acquire basic video image coding data from the buffer, which has been received before supplementary video image coding data that has been received at the moment of the switch in resolutions.

58. The '303 Accused Products reconstruct video image coding data from the basic video image coding data and the supplementary video image coding data:

### 7.12.3. Reconstruct process

The reconstruct process is invoked to perform dequantization, inverse transform and reconstruction. This process is triggered at a point defined by a function call to reconstruct in the transform block syntax table described in [section 5.11.35](#).

The inputs to this process are:

- a variable plane specifying which plane is being reconstructed,
- variables x and y specifying the location of the top left sample in the CurrFrame[ plane ] array of the current transform block,
- a variable txSz, specifying the size of the transform block.

The outputs of this process are reconstructed samples in the current frame CurrFrame.

Source: <https://aomediacodec.github.io/av1-spec/av1-spec.pdf>, at page 294

59. LG has indirectly infringed and continues to indirectly infringe one or more claims of the '303 Patent, as provided by 35 U.S.C. § 271(b), by inducing infringement by others, such as LG's customers and end-users, in this District and elsewhere in the United States. For example, LG's customers and end-users directly infringe, either literally or under the doctrine of equivalents, through their use of the inventions claimed in the '303 Patent. LG induces this direct infringement through its affirmative acts of manufacturing, selling, distributing, and/or otherwise making available the '303 Accused Products, and providing instructions, documentation, and other information to customers and end-users suggesting that they use the '303 Accused Products in an infringing manner, including technical support, marketing, product manuals, advertisements, and online documentation. Because of LG's inducement, LG's customers and end-users use the '303 Accused Products in a way LG intends and they directly infringe the '303 Patent. LG performs these affirmative acts with knowledge of the '303 Patent and with the intent, or willful blindness, that the induced acts directly infringe the '303 Patent.

60. LG has indirectly infringed and continues to indirectly infringe one or more claims of the '303 Patent, as provided by 35 U.S.C. § 271(c), by contributing to direct infringement by

others, such as customers and end-users, in this District and elsewhere in the United States. LG's affirmative acts of selling and offering to sell the '303 Accused Products in this District and elsewhere in the United States and causing the '303 Accused Products to be manufactured, used, sold, and offered for sale contribute to others' use and manufacture of the '303 Accused Products, such that the '303 Patent is directly infringed by others. The accused components within the '303 Accused Products including, but not limited to, software manufactured by LG, are material to the invention of the '303 Patent, are not staple articles or commodities of commerce, have no substantial non-infringing uses, and are known by LG to be especially made or adapted for use in the infringement of the '303 Patent. LG performs these affirmative acts with knowledge of the '303 Patent and with intent, or willful blindness, that they cause the direct infringement of the '303 Patent.

61. ACT has suffered damages as a result of Defendants' direct and indirect infringement of the '303 Patent in an amount to be proved at trial.

**COUNT IV**  
**(Infringement of the '995 Patent)**

62. Paragraphs 1 through 19 are incorporated by reference as if fully set forth herein.

63. ACT has not licensed or otherwise authorized Defendants to make, use, offer for sale, sell, or import any products that embody the inventions of the '995 Patent.

64. Defendants have and continue to directly infringe the '995 Patent, either literally or under the doctrine of equivalents, without authority and in violation of 35 U.S.C. § 271, by making, using, offering to sell, selling, and/or importing into the United States products that satisfy each and every limitation of one or more claims of the '995 Patent. Such products include at least LG Televisions compliant with the AV1 and/or SVT-AV1 Standards, including, but not limited to, the LG Z2, LG G2, LG C2, LG B2, LG A2, LG QNED99 2022, LG QNED90 2022, LG QNED85

2022, LG QNED80 2022, LG NANO80 2022, LG NANO75 2022, LG UQ90, LG UQ80, LG UQ75, LG UQ70, LG Z1, LG G1, LG C1, LG B1, LG A1, LG QNED99, LG QNED95, LG QNED90, LG NANO99 2021, LG NANO90 2021, LG NANO80 2021, LG NANO75, LG UP80, LG RX, LG ZX, LG WX, LG GX, LG CX, LG BX, LG NANO99, LG NANO90, LG NANO85, LG UN85, and the LG UN73 (the '995 Accused Products) which include a demultiplexer configured to work on a sequence of input encoded bits to implement a process for a prescribed demultiplexing to output at least a first and a second sequence of encoded bits; a first decoder configured to acquire the first sequence of encoded bits obtained with a standard resolution at the demultiplexer to implement thereon a process for a prescribed first decoding to create a sequence of decoded pictures with a standard resolution; a first super-resolution enlarger configured to acquire the sequence of decoded pictures created with a standard resolution at the first decoder to work on the sequence of decoded pictures to implement an interpolation of pixels with a first enlargement to create a sequence of super-resolution enlarged decoded pictures with a first resolution higher than a standard resolution; a first resolution converter configured to acquire the sequence of super-resolution enlarged decoded pictures created at the first super-resolution enlarger to work on the sequence of super-resolution enlarged decoded pictures to implement a process for a prescribed resolution conversion to create a sequence of super-resolution decoded pictures with a standard resolution; a second decoder configured to acquire the second sequence of encoded bits obtained with a standard resolution at the demultiplexer as a set of decoding targets, the sequence of decoded pictures created with the standard resolution at the first decoder as a set of first reference pictures, and the sequence of super-resolution decoded pictures created with the standard resolution at the first resolution converter as a set of second reference pictures, and select one of the set of first reference pictures and the set of second reference pictures based on reference

picture selection information to implement a combination of processes for a prescribed prediction and a prescribed second decoding being a decoding with an extension of the standard resolution, to create a sequence of super-resolution pictures decoded with the standard resolution based on the set of decoding targets and the set of selected reference pictures; and a second resolution converter configured to acquire the sequence of decoded pictures with the standard resolution from the first decoder to work on the sequence of decoded pictures to implement an interpolation of pixels with the second enlargement to create a sequence of enlarged decoded pictures with a high resolution as a second resolution higher than the standard resolution, wherein the set of decoding targets, the set of first reference pictures, and the set of second reference pictures have the same value in spatial resolution.

65. For example, Defendants have and continue to directly infringe at least claim 2 of the '995 Patent by making, using, offering to sell, selling, and/or importing into the United States televisions that are compliant with the AV1 and/or SVT-AV1 Standards, such as the '995 Accused Products.

66. The '995 Accused Products include a demultiplexer configured to work on a sequence of input encoded bits to implement a process for a prescribed demultiplexing to output at least a first and a second sequence of encoded bits. AV1 and/or SVT-AV1 consist of a pipeline with either super-resolution being active or inactive for each frame. The demultiplexer generates two sequences of bits, the first sequence of bits being the I-Frames sent to a first decoder, and the second sequence of bits being P-Frames sent to a second decoder:

### 5.9.2. Uncompressed header syntax

```
FrameIsIntra = 1
```

Source: <https://aomediacodec.github.io/av1-spec/av1-spec.pdf>, Page 37-38

## II. HIGH-LEVEL SYNTAX

The AV1 bitstream is packetized into open bitstream units (OBUs). An ordered sequence of OBUs is fed into the AV1 decoding process, where each OBU comprises a variable length string of bytes. An OBU contains a header and a payload. The header identifies the OBU type and specifies the payload size. Typical OBU types include the following.

- 1) **Sequence Header** contains information that applies to the entire sequence, e.g., sequence profile (see Section VIII) and whether to enable certain coding tools.
- 2) **Temporal Delimiter** indicates the frame presentation time stamp. All displayable frames following a temporal delimiter OBU will use this time stamp, until the next temporal delimiter OBU arrives. A temporal delimiter and its subsequent OBUs of the same time stamp are referred to as a temporal unit. In the context of scalable coding, the compression data associated with all representations of a frame at various spatial and fidelity resolutions will be in the same temporal unit.

- 3) **Frame Header** sets up the coding information for a given frame, including signaling inter or intraframe type, indicating the reference frames and signaling probability model update method.
- 4) **Tile Group** contains the tile data associated with a frame. Each tile can be independently decoded. The collective reconstructions form the reconstructed frame after potential loop filtering.
- 5) **Frame** contains the frame header and tile data. The frame OBU is largely equivalent to a frame header OBU and a tile group OBU but allows less overhead cost.
- 6) **Metadata** carries information, such as high dynamic range, scalability, and timecode.
- 7) **Tile List** contains tile data similar to a tile group OBU. However, each tile here has an additional header that indicates its reference frame index and position in the current frame. This allows the decoder to process a subset of tiles and display the corresponding part of the frame, without the need to fully decode all the tiles in the frame. Such capability is desirable for light field applications [13].

We refer to [9] for bit field definitions and more detailed consideration of high-level syntax.

67. The '995 Accused Products include a first decoder configured to acquire the first sequence of encoded bits and decodes the I-Frames received from the demultiplexer:

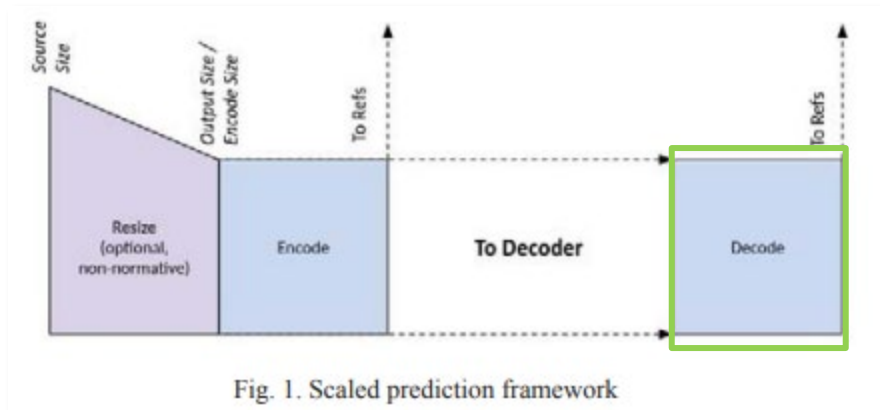

Fig. 1. Scaled prediction framework

Source: <https://sci-hub.se/https://ieeexplore.ieee.org/document/8954553>

68. The '995 Accused Products include a first super-resolution enlarger configured to acquire the sequence of decoded pictures created with a standard resolution at the first decoder. With super-resolution active, after the normal decoding process is completed, the decoded I-Frames (*i.e.*, sequence of decoded pictures created with a standard resolution at the first decoder)

are further sent to the deblocking, CDEF, upscale, and loop restoration block, where the decoded pictures are enlarged and upscaled to the original resolution (*i.e.*, higher than the standard resolution). In AV1 and/or SVT-AV1, the upscaling and loop restoration operations are referred to as the super-resolve steps (*i.e.*, the first super-resolution enlarger):

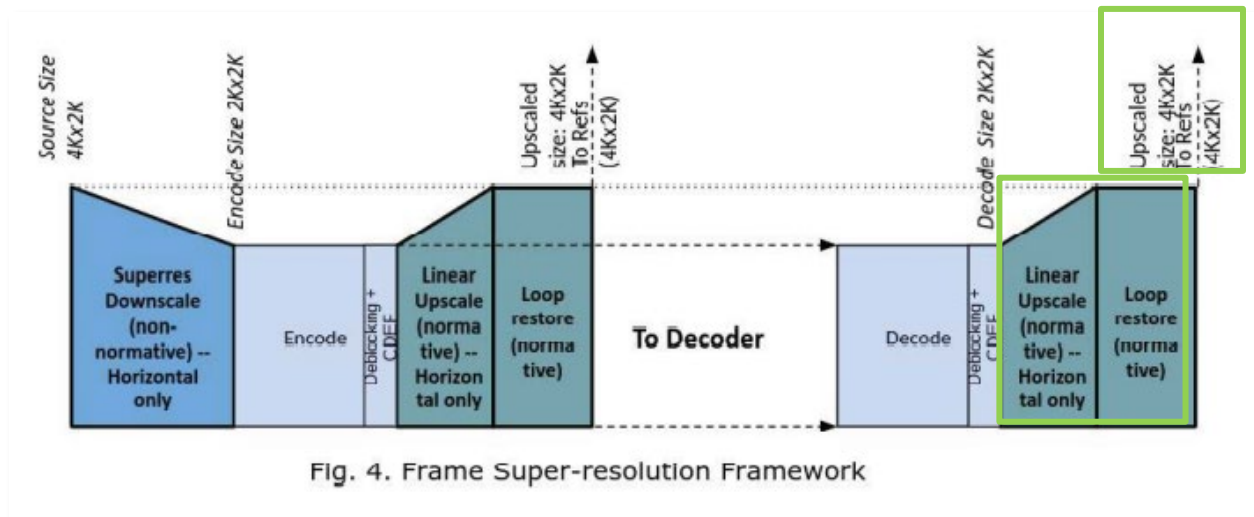

Fig. 4. Frame Super-resolution Framework

Source: <https://sci-hub.se/https://ieeexplore.ieee.org/document/8954553>

## 7.16. Upscaling process

Input to this process is an array `inputFrame` of width `FrameWidth` and height `FrameHeight`.

The output of this process is a horizontally upscaled frame of width `UpscaledWidth` and height `FrameHeight`.

If `use_superres` is equal to 0, no upscaling is required and this process returns `inputFrame`.

Source: <https://aomediacodec.github.io/av1-spec/av1-spec.pdf>, Page 325

69. The '995 Accused Products include a first resolution converter configured to acquire the sequence of super-resolution enlarged decoded pictures created at the first super-resolution enlarger to work on the sequence of super-resolution enlarged decoded pictures to implement a process for a prescribed resolution conversion to create a sequence of super-resolution decoded pictures with a standard resolution. After the loop restoration process, the reconstructed

I-Frames are added to the reference buffer list which are further used for decoding of P-Frames. The reference pictures at the decoding side are scaled according to the resolution of current P-frame which is to be decoded. Since the first super-resolution enlarger provides an upscaled decoded reference pictures, the reference pictures are downscaled to match current P-Frame's resolution (frame being decoded by 2nd decoder) to be used as reference picture:

#### *A. Scaled Prediction*

In order to enable the codec to switch frame resolutions mid-stream, both AV1 and its predecessor VP9 support the ability to predict across scales in the inter prediction loop. As shown schematically in Fig. 1, this allows any frame or frames to be non-normatively downsampled or upsampled (Fig. 1 shows downscaling only) on-the-fly before encoding at a different resolution. The reconstructed frame after encoding at the reduced or increased resolution then replaces one of the reference buffer slots at that resolution. Therefore, at any point during the encoding and decoding process, any inter frame could be predicted from references that are at different resolutions, and consequently a normative mechanism to predict a block in that frame from a different resolution reference buffer needs to be defined. In principle, as long as we have defined a normative upscaler and a normative downscaler, such prediction across scales would be possible to support. However it would be more compute efficient to combine such rescaling with subpel interpolation for motion compensation, and that is what AV1 does.

Source: <https://sci-hub.se/https://ieeexplore.ieee.org/document/8954553>

70. The '995 Accused Products include a second decoder configured to acquire the second sequence of encoded bits obtained with a standard resolution at the demultiplexer as a set of decoding targets, the sequence of decoded pictures created with the standard resolution at the first decoder as a set of first reference pictures, and the sequence of super-resolution decoded pictures created with the standard resolution at the first resolution converter as a set of second reference pictures, and select one of the set of first reference pictures and the set of second reference pictures based on reference picture selection information to implement a combination of

processes for a prescribed prediction and a prescribed second decoding being a decoding with an extension of the standard resolution, to create a sequence of super-resolution pictures decoded with the standard resolution based on the set of decoding targets and the set of selected reference pictures. The second decoder decodes the P-Frames. When frames are decoded without super-resolution being active and being used as reference frames, the reconstructed frames are used for inter-prediction of the current frame. When super-resolution is active, AV1 and/or SVT-AV1 produce decoded frames which are references that are super-resolved and then downscaled to match the current frame resolution. The second decoder waits for the current P-Frame to be decoded as received from the demultiplexer, and when it is received, the frame can be decoded based on the relevant reference I-Frame, whether super-resolved or non-super-resolved:

#### *A. Scaled Prediction*

In order to enable the codec to switch frame resolutions mid-stream, both AV1 and its predecessor VP9 support the ability to predict across scales in the inter prediction loop. As shown schematically in Fig. 1, this allows any frame or frames to be non-normatively downsampled or upsampled (Fig. 1 shows downscaling only) on-the-fly before encoding at a different resolution. The reconstructed frame after encoding at the reduced or increased resolution then replaces one of the reference buffer slots at that resolution. Therefore, at any point during the encoding and decoding process, any inter frame could be predicted from references that are at different resolutions, and consequently a normative mechanism to predict a block in that frame from a different resolution reference buffer needs to be defined. In principle, as long as we have defined a normative upscaler and a normative downscaler, such prediction across scales would be possible to support. However it would be more compute efficient to combine such rescaling with subpel interpolation for motion compensation, and that is what AV1 does.

Source: <https://sci-hub.se/https://ieeexplore.ieee.org/document/8954553>

71. Since AV1 and/or SVT-AV1 allow each frame to either be normally decoded or decoded with super-resolve steps, the reference picture buffer set consists of both non-super-

resolved and super-resolved reference pictures (reconstructed frames). For the second decoder to decode the current frame, the reference frame is selected based on the reference index. The reference index, which indicates whether a super-resolved or non-super-resolved reconstructed frame is selected, is the reference picture selection information that is sent in the encoded bitstream.

**ref\_frame\_idx[ i ]** specifies which reference frames are used by inter frames. It is a requirement of bitstream conformance that `RefValid[ ref_frame_idx[ i ] ]` is equal to 1, and that the selected reference frames match the current frame in bit depth, profile, chroma subsampling, and color space.

**Note:** Syntax elements indicate a reference (such as `LAST_FRAME`, `ALTREF_FRAME`). These references are looked up in the `ref_frame_idx` array to find which reference frame should be used during inter prediction. There is no requirement that the values in `ref_frame_idx` should be distinct.

Source: <https://aomediacodec.github.io/av1-spec/av1-spec.pdf>, Page 327

72. The '995 Accused Products include a second resolution converter configured to acquire the sequence of decoded pictures with the standard resolution from the first decoder to work on the sequence of decoded pictures to implement an interpolation of pixels with the second enlargement to create a sequence of enlarged decoded pictures with a high resolution as a second resolution higher than the standard resolution, wherein the set of decoding targets, the set of first reference pictures, and the set of second reference pictures have the same value in spatial resolution. In AV1 and/or SVT-AV1, the output of the 1st decoder (when super-resolution is not active), the decoded frames (reconstructed references) can also be upscaled. AV1 and/or SVT-AV1 use different 8-tap filter coefficient that can be used for upscaling of the decoded frame.

```

const int16_t av1_resize_filter_normative[(
    1 << RS_SUBPEL_BITS)][UPSCALE_NORMATIVE_TAPS] = {
#if UPSCALE_NORMATIVE_TAPS == 8
    { 0, 0, 0, 128, 0, 0, 0, 0 },      { 0, 0, -1, 128, 2, -1, 0, 0 },
    { 0, 1, -3, 127, 4, -2, 1, 0 },    { 0, 1, -4, 127, 6, -3, 1, 0 },
    { 0, 2, -6, 126, 8, -3, 1, 0 },    { 0, 2, -7, 125, 11, -4, 1, 0 },
    { -1, 2, -8, 125, 13, -5, 2, 0 },   { -1, 3, -9, 124, 15, -6, 2, 0 },

```

Source: <https://aomedia.googlesource.com/aom/+refs/heads/main/av1/common/resize.c>

After the reference pictures are selected from the first and second set of reference pictures, the reference pictures are upsampled or downsampled to match to resolution of the encoding targets:

Fig. 2 shows a scenario where a 4x4 block from the source needs to be predicted from a different resolution reference buffer. The motion vectors transmitted in the bitstream are always at the source resolution. So they are first scaled up or down based on the resolution ratio between the reference and source, and the corresponding source block pixels projected on the reference grid can then be obtained, as shown on the right of Fig. 2. Note that the relative sub-pixel positions horizontally (vertically) on the reference grid are the same in each row (column). Hence, the interpolation for scaled prediction can be implemented simply as separable filtering in each dimension using a suitable starting sub-pixel offset and a sub-pixel step between pixels.

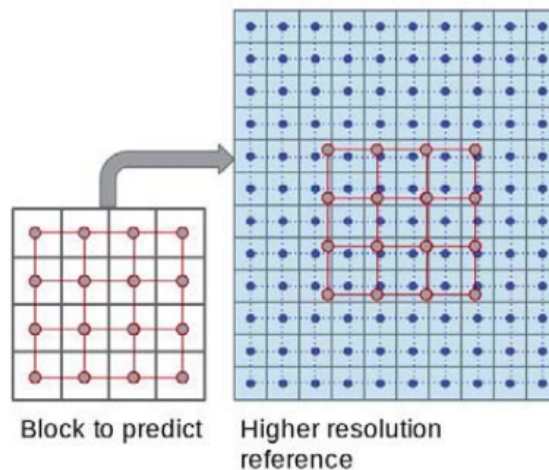

Fig. 2. Predicting a block from different (higher shown) resolution reference

Source: <https://sci-hub.se/https://ieeexplore.ieee.org/document/8954553>, Page 2

73. LG has indirectly infringed and continues to indirectly infringe one or more claims of the '995 Patent, as provided by 35 U.S.C. § 271(b), by inducing infringement by others, such as LG's customers and end-users, in this District and elsewhere in the United States. For example, LG's customers and end-users directly infringe, either literally or under the doctrine of equivalents, through their use of the inventions claimed in the '995 Patent. LG induces this direct infringement through its affirmative acts of manufacturing, selling, distributing, and/or otherwise making available the '995 Accused Products, and providing instructions, documentation, and other information to customers and end-users suggesting that they use the '995 Accused Products in an infringing manner, including technical support, marketing, product manuals, advertisements, and online documentation. Because of LG's inducement, LG's customers and end-users use the '995 Accused Products in a way LG intends and they directly infringe the '995 Patent. LG performs these affirmative acts with knowledge of the '995 Patent and with the intent, or willful blindness, that the induced acts directly infringe the '995 Patent.

74. LG has indirectly infringed and continues to indirectly infringe one or more claims of the '995 Patent, as provided by 35 U.S.C. § 271(c), by contributing to direct infringement by others, such as customers and end-users, in this District and elsewhere in the United States. LG's affirmative acts of selling and offering to sell the '995 Accused Products in this District and elsewhere in the United States and causing the '995 Accused Products to be manufactured, used, sold, and offered for sale contribute to others' use and manufacture of the '995 Accused Products, such that the '995 Patent is directly infringed by others. The accused components within the '995 Accused Products including, but not limited to, software manufactured by LG, are material to the invention of the '995 Patent, are not staple articles or commodities of commerce, have no substantial non-infringing uses, and are known by LG to be especially made or adapted for use in

the infringement of the '995 Patent. LG performs these affirmative acts with knowledge of the '995 Patent and with intent, or willful blindness, that they cause the direct infringement of the '995 Patent.

75. ACT has suffered damages as a result of Defendants' direct and indirect infringement of the '995 Patent in an amount to be proved at trial.

**DEMAND FOR JURY TRIAL**

Plaintiff hereby demands a jury for all issues so triable.

**PRAYER FOR RELIEF**

WHEREFORE, ACT prays for relief against Defendants as follows:

a. Entry of judgment declaring that Defendants have directly and/or indirectly infringed one or more claims of each of the Patents-in-Suit;

b. An order pursuant to 35 U.S.C. § 283 permanently enjoining Defendants, their officers, agents, servants, employees, attorneys, and those persons in active concert or participation with them, from further acts of infringement of the Patents-in-Suit;

c. An order awarding damages sufficient to compensate ACT for Defendants' infringement of the Patents-in-Suit, but in no event less than a reasonable royalty, together with interest and costs;

d. Entry of judgment declaring that this case is exceptional and awarding ACT its costs and reasonable attorney fees under 35 U.S.C. § 285; and

e. Such other and further relief as the Court deems just and proper.

Dated: December 30, 2022

Respectfully submitted,

/s/ Alfred R. Fabricant  
Alfred R. Fabricant  
NY Bar No. 2219392  
Email: ffabricant@fabricantllp.com  
Peter Lambrianakos

NY Bar No. 2894392  
Email: plambrianakos@fabricantllp.com

Vincent J. Rubino, III

NY Bar No. 4557435

Email: vrubino@fabricantllp.com

Joseph M. Mercadante

NY Bar No. 4784930

Email: jmercadante@fabricantllp.com

**FABRICANT LLP**

411 Theodore Fremd Avenue, Suite 206 South

Rye, New York 10580

Telephone: (212) 257-5797

Facsimile: (212) 257-5796

Samuel F. Baxter

Texas State Bar No. 01938000

Email: sbaxter@mckoolsmith.com

Jennifer L. Truelove

Texas State Bar No. 24012906

Email: jtruelove@mckoolsmith.com

**MCKOOL SMITH, P.C.**

104 E. Houston Street, Suite 300

Marshall, Texas 75670

Telephone: (903) 923-9000

Facsimile: (903) 923-9099

***ATTORNEYS FOR PLAINTIFF***

***ADVANCED CODING TECHNOLOGIES, LLC***