**Near Field Communication -
Interface and Protocol
(NFCIP-1)**

**Near Field Communication -
Interface and Protocol
(NFCIP-1)**

Brief History

This Standard specifies the interface and protocol for simple wireless communication between close coupled devices. These Near Field Communication (NFC) devices communicate with transfer rates of 106, 212, and 424 kbps.

This NFC Interface and Protocol (NFCIP-1) standard allows, but does not specify, applications in network products and consumer equipment.

This ECMA Standard has been adopted by the General Assembly of December 2002.

Table of contents

1	Scope	1
2	Conformance	1
3	References	1
4	Definitions	1
4.1	Active communication mode	1
4.2	ASK modulation	1
4.3	Binary Coded Decimal (BCD)	1
4.4	Collision	1
4.5	Frame	1
4.6	Initiator	1
4.7	Load modulation	1
4.8	lsb first	1
4.9	LSB first	2
4.10	Manchester coding	2
4.11	Modulation index	2
4.12	msb first	2
4.13	MSB first	2
4.14	NFCIP-1 device	2
4.15	NFC Identifier (NFCID n)	2
4.16	Passive communication mode	2
4.17	RF Collision Avoidance (RFCA)	2
4.18	SEL_PAR	2
4.19	Sensing	2
4.20	Single Device Detection (SDD)	2
4.21	Subcarrier	2
4.22	Target	2
4.23	Time Period	2
4.24	Time Slot	3
4.25	transaction	3
5	Conventions and notations	3
5.1	Representation of numbers	3
5.2	Names	3
6	Acronyms	3
7	General	5
8	RF field	6
8.1	Passive Communication Mode	6
8.2	Active Communication Mode	6

9	RF Signal Interface	6
9.1	Bit duration	6
9.2	Active communication mode	6
9.2.1	106 kbps	6
9.2.2	212 kbps and 424 kbps	8
9.3	Passive communication mode	9
9.3.1	106 kbps Initiator to Target	9
9.3.2	106 kbps Target to Initiator	10
9.3.3	212 kbps and 424 kbps Initiator to Target	10
9.3.4	212 kbps and 424 kbps Target to Initiator	10
10	General Protocol flow	11
11	Initialisation	12
11.1	RF Collision Avoidance	12
11.1.1	Initial RF Collision Avoidance	13
11.1.2	Response RF Collision Avoidance	13
11.2	Passive communication mode	14
11.2.1	Initialisation and Single Device Detection at 106 kbps	14
11.2.2	Initialisation and SDD at 212 kbps and 424 kbps	26
11.3	Active communication mode	29
11.3.1	Initialisation at 106, 212, and 424 kbps	29
11.3.2	Active communication mode RF Collision Avoidance	29
12	Transport Protocol	30
12.1	Transport Data	30
12.2	Passive communication mode Activation flow	31
12.3	Active communication mode Activation flow	33
12.4	Commands	35
12.5	Activation of the protocol	35
12.5.1	Attribute Request and Response Commands	35
12.5.2	Wakeup Request and Response Commands	40
12.5.3	Parameter Selection Request and Response Commands	41
12.6	Data Exchange Protocol	44
12.6.1	Data Exchange Protocol Request and Response	44
12.6.2	Response timeout extension	47
12.6.3	Attention – Target present	47
12.6.4	Protocol operation	47
12.6.5	Multi Activation	48
12.6.6	More information (Chaining)	48
12.7	Deactivation of the protocol	49
12.7.1	Deselect Request and Response command	49
12.7.2	Release Request and Response commands	50
Annex A	- CRC calculation	53

1 Scope

This Standard defines communication modes for Near Field Communication Interface and Protocol (NFCIP-1) using inductive coupled devices operating at the centre frequency of 13,56 MHz for interconnection of computer peripherals. It also defines both the Active and the Passive communication modes of Near Field Communication Interface and Protocol (NFCIP-1) to realise a communication network using Near Field Communication devices for networked products and also for consumer equipment. The Standard specifies, in particular, modulation schemes, codings, transfer speeds, and frame format of the RF interface, as well as initialisation schemes and conditions required for data collision control during initialisation. Furthermore, this ECMA Standard defines a transport protocol including protocol activation and data exchange methods.

Information interchange between systems also requires, at a minimum, agreement between the interchange parties upon the interchange codes and the data structure.

2 Conformance

A system implementing the Active and the Passive communication mode shall be in conformance with this ECMA Standard if it meets all the mandatory requirements specified herein.

3 References

ITU-T V.41 Code-independent error-control system (1988-11)

4 Definitions

The following definitions apply in this ECMA Standard.

4.1 Active communication mode

Both the Initiator and the Target use their own RF field to enable the communication. This is the scheme of the Active communication mode.

4.2 ASK modulation

ASK stands for Amplitude Shift Keying. The amplitude of the carrier frequency is modulated according to the logic of the data to be transmitted. The degree of modulation is expressed by $(a - b)/(a + b) \times 100$ [%], where a and b respectively represent the maximum and minimum amplitudes of the modulated signal waveform.

4.3 Binary Coded Decimal (BCD)

A system for representing each of the decimal numbers 0 to 9 by a four-bit binary code. The bits, from left to right, are worth 8, 4, 2 and 1 respectively in decimal, so for example the number 6 in BCD is 0110.

4.4 Collision

Transmission by two or more Targets or Initiators during the same time period, such that the Initiator or the Target is unable to distinguish from which Target the data originated.

4.5 Frame

Sequence of data bits and optional error detection bits, with frame delimiters at start and end.

4.6 Initiator

Generates the RF field and starts the NFCIP-1 communication.

4.7 Load modulation

Process of amplitude modulating a radio frequency field by varying the properties of a resonant circuit placed within the radio frequency field.

4.8 lsb first

least significant bit first. Indicates a serial data transmission system that sends lsb before all other bits.

4.9 LSB first

Least Significant Byte first. Indicates a serial data transmission system that sends LSB before all other bytes.

4.10 Manchester coding

Method of bit coding whereby a logic level during a bit duration is represented by a sequence of two defined physical states of a communication medium. The order of the physical states within the sequence defines the logical state.

The coding system which divides into half at the changing point in the middle point of bit self-sustaining time, and makes the direction of the changes correspond to two logic value.

4.11 Modulation index

Defined as $(a - b)/(a + b)$ where a and b are the peak and the minimum signal amplitude respectively with the value of the index possibly expressed as a percentage. When the maximum amplitude of the modulated signal waveform is set to a and the minimum value is set to b , the degree of abnormal conditions is usually expressed as a percent.

4.12 msb first

most significant bit. Indicates a serial data transmission system that sends the msb before all other bits.

4.13 MSB first

Most Significant Byte. Indicates a serial data transmission system that sends the MSB before all other bytes.

4.14 NFCIP-1 device

General term for either an Initiator or a Target communicating in the Active or the Passive communication mode.

4.15 NFC Identifier (NFCID n)

NFCID n is a randomly generated number used by the RF Collision Avoidance and Single Device Detection sequence for both the Active and the Passive communication modes.

4.16 Passive communication mode

The Initiator is generating the RF field and the Target responds to an Initiator command in a load modulation scheme.

4.17 RF Collision Avoidance (RFCA)

Method to detect the presence of a RF field based on the carrier frequency and method to detect and resolve collisions on protocol level.

4.18 SEL_PAR

Total number of valid bits of NFCID1 CL n including SEL_CMD and SEL_PAR transmitted by the Initiator.

4.19 Sensing

An NFCIP-1 device in the Active communication mode expects a Response to a Request it has sent on the RF field to detect the start of communication to receive the Request.

4.20 Single Device Detection (SDD)

SDD is an algorithm used by the initiator to detect one out of several Targets in its RF field.

4.21 Subcarrier

Signal of frequency f_s used to modulate a carrier of frequency f_c .

4.22 Target

Target responds to Initiator command either using load modulation scheme (RF field generated by Initiator) or using modulation of self generated RF field.

4.23 Time Period

The Time Period defines the number of slots used for RF Collision Avoidance.

4.24 Time Slot

Method of preparing a time window when a Target answers, and assign and identify two or more logic channels.

4.25 transaction

A transaction includes the initialisation and the transparent data exchange between an Initiator and a Target either in the Active or the Passive communication mode.

5 Conventions and notations

5.1 Representation of numbers

The following conventions and notations apply in this document unless otherwise stated.

- Letters and digits in parentheses represent numbers in hexadecimal notation.
- The setting of bits is denoted by ZERO or ONE.
- Numbers in binary notation and bit patterns are represented by strings of digits 0 and 1 shown with the most significant bit to the left. Within such strings, X may be used to indicate that the setting of a bit is not specified within the string.

5.2 Names

The names of basic elements, e.g. specific fields, are written with a capital initial letter.

6 Acronyms

ALL_REQ	Wake up ALL Request
ASK	Amplitude Shift Keying
ATR	Attribute Request and Attribute Response
ATR_REQ	Attribute Request
ATR_RES	Attribute Response
BCC	NFCID1 CL n check byte, calculated as exclusive-or over the 4 previous bytes
BCD	Binary Code Decimal
<i>bd</i>	Bit duration
BR i	Receiving bit duration supported by Initiator
BR t	Receiving bit duration supported by Target
BS i	Sending bit duration supported by Initiator
BS t	Sending bit duration supported by Target
CL n	Cascade Level n , $3 \geq n \geq 1$
CMD	Command
CRC	Cyclic Redundancy Check
CT	Cascade Tag
D	Divisor
DEP	Data Exchange Protocol Request and Data Exchange Protocol Response
DEP_REQ	Data Exchange Protocol Request
DEP_RES	Data Exchange Protocol Response
DID i	Initiator Device ID
DID t	Target Device ID

DRi	Data rate Received by initiator
DRt	Data rate Received by initiator
DSi	Data rate Send by initiator
DSL	Deselect Request and Deselect Response
DSL_REQ	Deselect Request
DSL_RES	Deselect Response
DSt	Data rate Send by Target
fc	Frequency of operating field (carrier frequency)
fd	Baseband frequency of Manchester coding
FRT	Frame Response Time
fs	Frequency of subcarrier (fc/16)
Gi	Optional information field for Initiator
Gt	Optional information field for Target
ID	Identification number
lsb	least significant bit
LSB	Least Significant Byte
MI	Multiple Information link for Data Exchange Protocol
msb	most significant bit
MSB	Most Significant Byte
NAD	Node Address
NFCID1	Random Identifier for single device detection in the Passive communication mode at 106 kbps
nfcid1 n	Byte number n of NFCID1
NFCID2	Random ID for SDD in the Passive communication mode at 212 kbps and 424 kbps
nfcid2 n	Byte number n of the Random Identifier NFCID2
NFCID3	Random ID for transport protocol activation
nfcid3 n	Byte number n of the Random Identifier NFCID3
P	Odd parity bit
PA	Preamble
pdu	protocol data unit
PFB	Control information for transaction
PNI	Packet Number Information
PPi	Protocol Parameters used by Initiator
PPt	Protocol Parameters used by Target
PSL	Parameter Selection Request and Parameter Selection Response
PSL_REQ	Parameter Selection Request
PSL_RES	Parameter Selection Response
RF	Radio Frequency
RFCA	RF Collision Avoidance

RFU	Reserved for Future Use
RLS	Release Request and Release Response
RLS_REQ	Release Request
RLS_RES	Release Response
RWT	Response Waiting Time
SB	Start byte for data exchange protocol at 106 kbps
SDD	Single Device Detection
SDD_REQ	Single Device Detection Request command
SEL_CMD	Select Command byte
SEL_PAR	Select Parameter byte
SEL_REQ	Select Request command
SENS_REQ	Sense Request command
SENS_RES	Sense Response command
SLP_REQ	Sleep Request command
SYNC	Synchronous pattern
TO	Timeout value
WT	Waiting Time
WUP	Wakeup Request and Wakeup Response
WUP_REQ	Wakeup Request
WUP_RES	Wakeup Response

7 General

This ECMA Standard defines both the Active and the Passive communication modes as follows:

In the Active communication mode, both the Initiator and the Target shall use their own RF field to enable communication. The Initiator starts the NFCIP-1 communication. The Target responds to an Initiator command in the Active communication mode using self-generated modulation of self-generated the RF field.

In the Passive communication mode, the Initiator generates the RF field and starts the communication. The Target responds to an Initiator command in the Passive communication mode using a load modulation scheme.

The communication over the RF interface in the Active and the Passive communication mode shall include modulation schemes, transfer speed and bit coding. In addition it shall include the start of communication, the end of communication, the bit and byte representation, the framing and error detection, the single device detection, the protocol and parameter selection and the data exchange and de-selection of Near Field Communication Interface and Protocol (NFCIP-1) devices.

All NFCIP-1 devices shall have communication capability on 106 kbps and may switch to another transfer speed or stay at 106 kbps. All NFCIP-1 devices shall have communication capability on 212 kbps and may switch to another transfer speed or stay at 212 kbps. All NFCIP-1 devices shall have communication capabilities on 424 kbps and may switch to another transfer speed or stay at 424 kbps.

The mode (Active or Passive) shall not be changed during one transaction until the deactivation of the Target or removal of the Target, even though the transfer speed of Initiator to Target and the transfer speed of the Target to the Initiator may not be the same. The change of transfer speed during one transaction may be performed by a parameter change procedure.

The transaction is started by device initialisation and terminated by device de-selection (or equivalent).

8 RF field

The carrier frequency of the RF field shall be 13,56 MHz.

The minimum unmodulated RF field shall be H_{min} and has a value of 1,5 A/m rms.

The maximum unmodulated RF field shall be H_{max} and has a value of 7,5 A/m rms.

This field shall be modulated during communication.

8.1 Passive Communication Mode

An Initiator shall produce a RF field to energise the target.

A Target shall operate continuously between H_{min} and H_{max} .

8.2 Active Communication Mode

An Initiator and a Target shall alternately generate a RF field of at least H_{min} and not exceeding H_{max} at manufacturer specified positions (operating volume).

9 RF Signal Interface

9.1 Bit duration

The bit duration bd is calculated by the following formula:

$$1 \text{ } bd = 128 / (D \times fc)$$

The values of the divisor D depend on the bit rate and are given by table 1. The fc is the carrier frequency as defined in clause 8.

Table 1 – Definition of Divisor D

Communication Mode	kbps	Divisor D
active or passive	106	1
active or passive	212	2
active or passive	424	4
Active	848	8
Active	1 667	16
Active	3 390	32
Active	6 670	64

NOTE

The Initiator for starting the communication chooses the initial bit rate.

9.2 Active communication mode

The specification of both from the Initiator to the Target and from the Target to the Initiator shall be identical.

9.2.1 106 kbps

9.2.1.1 Bit rate

The bit rate for the transmission during initialisation and single device detection shall be $fc/128$ (106 kbps).

9.2.1.2 Modulation

Communication from the Initiator to a Target and a Target to the Initiator for a bit rate of $fc/128$ shall use the modulation principle of ASK 100% of the RF operating field to create a “Pulse” as shown in figure 1.

The envelope of the field shall decrease monotonically to less than 5% of its initial value $H_{INITIAL}$ and remain less than 5% for more than t_2 . (See table 2.) This envelope shall comply with figure 1.

If the envelope of the field does not decrease monotonically, the time between a local maximum and the time of passing the same value before the local maximum shall not exceed $0,5 \mu s$. This shall only apply if the local maximum is greater than 5% of $H_{INITIAL}$.

Overshoots shall remain within 90% and 110% of $H_{INITIAL}$.

The Target shall detect the “End of Pulse” after the field exceeds 5% of $H_{INITIAL}$ and before it exceeds 60% of $H_{INITIAL}$. The “End of Pulse” is defined by t_4 in table 2. This definition applies to all modulation envelope timings.

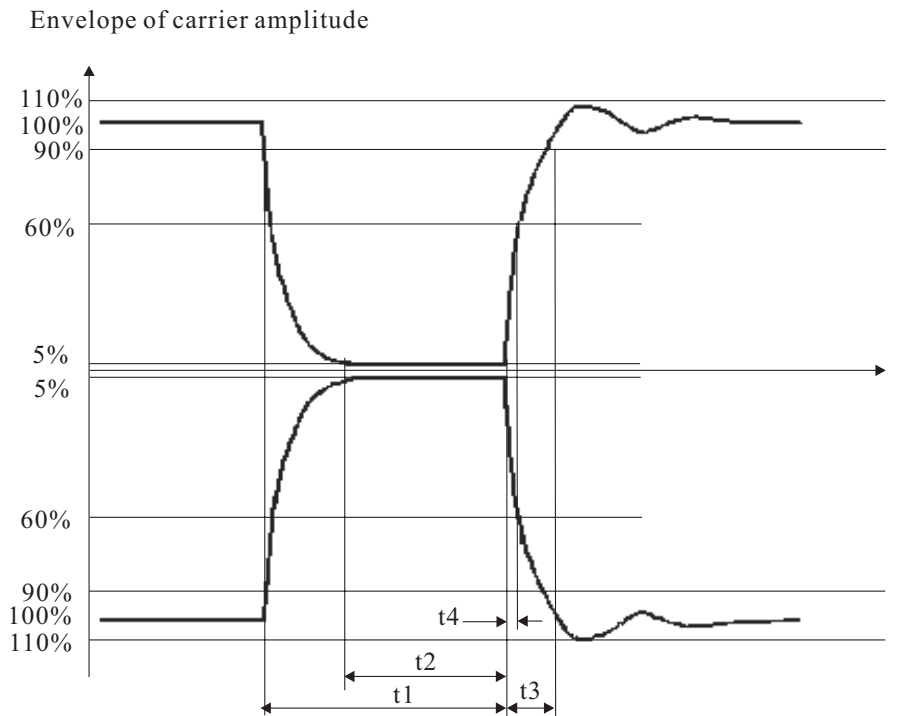

Figure 1 – Pulse shape

Table 2 – Pulse shape value

Pulses length (Condition)	t1 [μs]	t2 [μs]		t3 [μs]	t4 [μs]
		(t1 ≤ 2,5)	(t1 > 2,5)		
T max	3,0	t1		1,5	0,4
T min	2,0	0,7	0,5	0,0	0,0

9.2.1.3 Bit representation and coding

The following coding shall be used:

- Start of communication: at the beginning of the bit duration a “Pulse” shall occur.
- ONE: after a time of half the bit duration a “Pulse” shall occur.
- ZERO: For the full bit duration no modulation shall occur with the following two exceptions:
 - If there are two or more contiguous ZEROs, from the second ZERO on a Pulse shall occur at the beginning of the bit duration.

- If the first bit after a “start of communication” is ZERO, a ‘Pulse’ shall occur at the beginning of the bit duration.
- End of Communication: ZERO followed by one bit duration without modulation.
- No information: shall be coded with at least two full bit duration without modulation.

9.2.1.4 Byte encoding

The byte encoding shall be least significant bit (lsb) first.

9.2.2 212 kbps and 424 kbps

9.2.2.1 Bit rate

The bit rates for the transmission during initialisation and single device detection shall respectively be $f_c/64$ (212 kbps) or $f_c/32$ (424 kbps).

9.2.2.2 Modulation

The Initiator shall use the modulation of ASK with the modulation index of 8 % to 30 % of the operating field. The modulation waveform shall comply with figure 2. The rising and falling edges of the modulation shall be monotonic. The modulation for the transmission during initialisation and single device detection shall be the same. a and b define the peak and the minimum signal amplitude.

Table 3 – Modulated waveform

	212 kbps	424 kbps
tf	2,0 μ s max	1,0 μ s max
tr	2,0 μ s max	1,0 μ s max
y	0,1 ($a - b$)	0,1 ($a - b$)
hf, hr	0,1 ($a - b$) max	0,1 ($a - b$) max

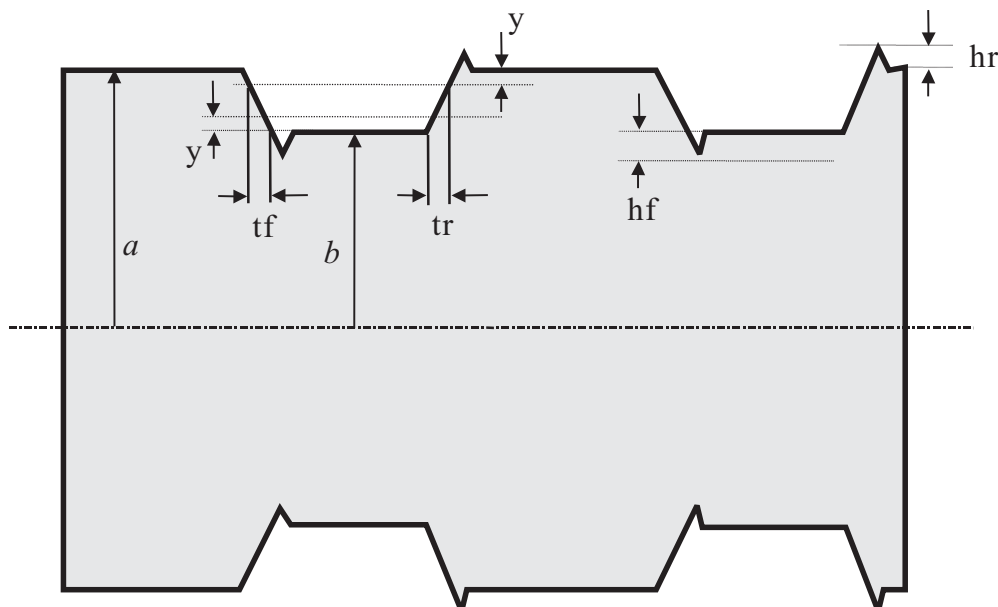

Figure 2 – Modulated Waveform

9.2.2.3 Bit representation and coding

Manchester bit encoding shall be employed. The waveform is shown in figure 3 and figure 4. Bit coding format is Manchester with logic levels defined as:

Logic “ZERO”: The first half of a bit is carrier low field amplitude, and the second half of the bit shall be carrier high field amplitude (no modulation applied).

Logic “ONE”: The first half of a bit is carrier high field amplitude (no modulation applied), and the second half of the bit shall be carrier low field amplitude.

Reverse polarity in amplitude shall be permitted. Polarity shall be detected from the SYNC.

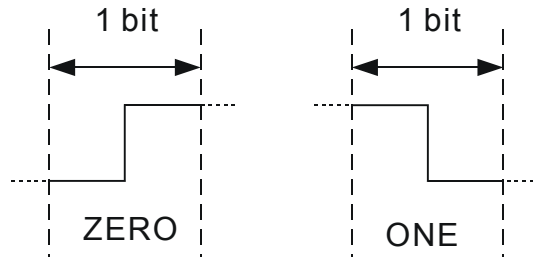

Figure 3 – Manchester bit encoding (obverse amplitude)

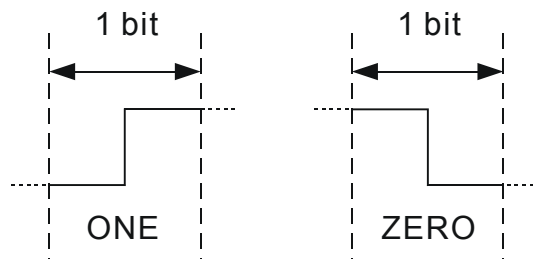

Figure 4 – Manchester bit encoding (reverse amplitude)

9.2.2.4 Byte encoding

The byte encoding shall be most significant bit (msb) first.

9.3 Passive communication mode

9.3.1 106 kbps Initiator to Target

9.3.1.1 Bit rate

The bit rate for transmission during initialisation and single device detection from the Initiator to the Target in the Passive communication mode shall be the same as the bit rate for communication from Initiator to the Target in the Active communication mode. See 9.2.1.1.

9.3.1.2 Modulation

The modulation for transmission during initialisation and single device detection from the Initiator to the Target in the Passive communication mode shall be the same as the modulation for communication from Initiator to the Target in the Active communication mode. See 9.2.1.2.

9.3.1.3 Bit representation and coding

The bit representation and coding for the transmission during initialisation and single device detection from the Initiator to the Target in the Passive communication mode shall be the same as the bit representation and coding for communication from Initiator to the Target in the Active communication mode. See 9.2.1.3.

9.3.1.4 Byte encoding

The byte encoding shall be least significant bit (lsb) first. See 9.2.1.4.

9.3.2 106 kbps Target to Initiator

9.3.2.1 Bit rate

The bit rate for the transmission during initialisation and single device detection shall be $f_c/128$.

9.3.2.2 Modulation

The Target shall respond to the Initiator via an inductive coupling area where the carrier frequency is loaded to generate a subcarrier with frequency f_s . The subcarrier shall be generated by switching a load in the Target.

The load modulation amplitude shall be at least $30/H^{1.2}$ (mV peak) where H is the (rms) value of magnetic field strength in A/m.

9.3.2.3 Subcarrier Frequency

The frequency f_s of the subcarrier shall be $f_c/16$.

9.3.2.4 Subcarrier modulation

Every bit period shall start with a defined phase relation to the subcarrier. The bit period shall start with the loaded state of the subcarrier.

The subcarrier shall be modulated with the sequences defined in clause 9.3.2.5.

9.3.2.5 Bit representation and coding

The Bit representation and coding is defined in clause 9.2.2.3 and shown in figure 3 Manchester Coding with obverse amplitude. Reverse polarity in amplitude shall be not allowed.

9.3.2.6 Byte encoding

The byte encoding shall be least significant bit (lsb) first.

9.3.3 212 kbps and 424 kbps Initiator to Target

9.3.3.1 Bit rate

The bit rate for transmission during initialisation and single device detection from the Initiator to the Target in the Passive communication mode shall be the same as the bit rate for communication from Initiator to the Target in the Active communication mode. See 9.2.2.1.

9.3.3.2 Modulation

The modulation for transmission during initialisation and single device detection from the Initiator to the Target in the Passive communication mode shall be the same as the modulation for communication from Initiator to the Target in the Active communication mode. See 9.2.2.2.

9.3.3.3 Bit representation and coding

The bit representation and coding for the transmission during initialisation and single device detection from the Initiator to the Target in the Passive communication mode shall be the same as the bit representation and coding for communication from Initiator to the Target in the Active communication mode. See 9.2.2.3.

9.3.3.4 Byte encoding

The byte encoding is defined in clause 9.2.2.4.

9.3.4 212 kbps and 424 kbps Target to Initiator

9.3.4.1 Bit rate

The bit rate for transmission during initialisation and single device detection from the Initiator to the Target in the Passive communication mode shall be the same as the bit rate for communication from Initiator to the Target in the Active communication mode. See 9.2.2.1.

9.3.4.2 Modulation

The Target shall be capable of communication to the Initiator via an inductive coupling area where the carrier frequency is loaded to generate a Manchester coding with bit duration bd . (See 9.2.) The Manchester coding shall be generated by switching a load in the Target.

The load modulation amplitude shall be at least $30/H^{1.2}$ (mV peak) where H is the (rms) value of magnetic field strength in A/m.

9.3.4.3 Bit representation and coding

The bit representation and coding for the transmission during initialisation and single device detection from the Initiator to the Target in the Passive communication mode shall be the same as the bit representation and coding for communication from Initiator to the Target in the Active communication mode. See 9.2.2.3.

9.3.4.4 Byte encoding

The byte encoding is defined in clause 9.2.2.4.

10 General Protocol flow

The General Protocol flow between NFCIP-1 devices shall be conducted through the following consecutive operations:

- Any NFCIP-1 device shall per default be in Target mode.
- When in Target mode, it shall not generate an RF field, and shall wait silently for a command from the Initiator.
- The NFCIP-1 device may switch to Initiator mode only if required by the application.
- The application shall determine either Active or Passive communication mode and transfer speed.
- Initiator shall test for external RF field present and shall not activate its RF field if an external RF field is detected.
- If an external RF field is not detected, the Initiator shall activate its RF field.
- The Target shall be activated by the RF field of the Initiator.
- Transmission of a command by the Initiator either in the Active communication mode or in the Passive communication mode at a selected transfer speed.
- Transmission of a response by the Target either in the Active communication mode or in the Passive communication mode. The communication mode and the transfer speed shall be the same as the Initiator communication mode and the transfer speed.

Figure 5 shows the general initialisation and single device detection flow for the Active and the Passive communication mode at different transfer speeds.

The General Protocol flow describes the flow to initialise and select the Targets either in the Passive communication mode or in the Active communication mode using one of the chosen transfer speeds. RF Collision Avoidance is described in clause 11.1. Passive communication mode is described in clause 11.2. The initialisation and SDD for 106 kbps is described in clause 11.2.1, initialisation and SDD for 212 kbps and 424 kbps is described in clause 11.2.2. The Active communication mode is described in clause 11.3.

The Activation of the Protocol is described in clause 12.5. The Parameter Selection is described in clause 12.5.3. The Data Exchange Protocol is described in clause 12.6. The Deactivation is described in clause 12.7.



Figure 5 – General initialisation and single device detection flow

11 Initialisation

This section describes the initialisation and collision detection protocol for Targets in the Active and the Passive communication mode. The Initiator shall detect a collision that occurs, when at least two Targets simultaneously transmit bit patterns with one or more bit positions where they transmit complementary values.

Figure 5 shows the general initialisation and Single Device Detection flow for the Active and the Passive communication mode at different transfer speeds.

11.1 RF Collision Avoidance

In order not to disturb any other NFC communication and any current infrastructure running on the carrier frequency, an Initiator for NFC communication shall not generate its own RF field as long as another RF field is detected.

11.1.1 Initial RF Collision Avoidance

To start communication with the Target device either in the Active or the Passive communication mode an Initiator shall sense continuously for the presence of an external RF field.

If the Initiator detects no RF field within the timeframe $T_{IDT} + n \times T_{RFW}$ the RF field shall switch on. The integer value of n is randomly generated. Figure 6 illustrates the initial RF Collision Avoidance during initialisation.

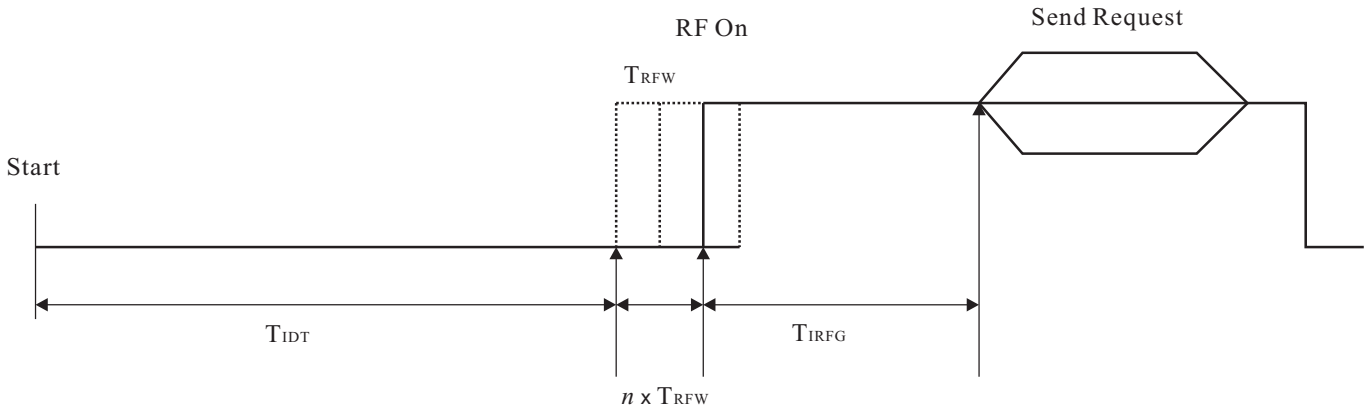

Figure 6 – Initial RF Collision Avoidance

T_{IDT} : Initial delay time. $T_{IDT} > 4\,096 / f_c$

T_{RFW} : RF waiting time. $512 / f_c$

n : randomly generated number of Time Periods for T_{RFW} .

$$0 \leq n \leq 3$$

T_{IRFG} : Initial guard-time between switching on RF field and start to send command or data frame.

$$T_{IRFG} > 5 \text{ ms}$$

The RF field, which is generated by the Initiator, shall be switched off in the Active communication mode. The RF field, which is generated by the Initiator, shall not be switched off in the Passive communication mode.

11.1.2 Response RF Collision Avoidance

In addition to the initial RF Collision Avoidance as described in clause 11.1.1. A response RF collision avoidance during activation shall be required in the Active communication mode to avoid collision of data by simultaneous responding of more than one target. Figure 7 illustrates the response RF Collision Avoidance sequence during initialisation.

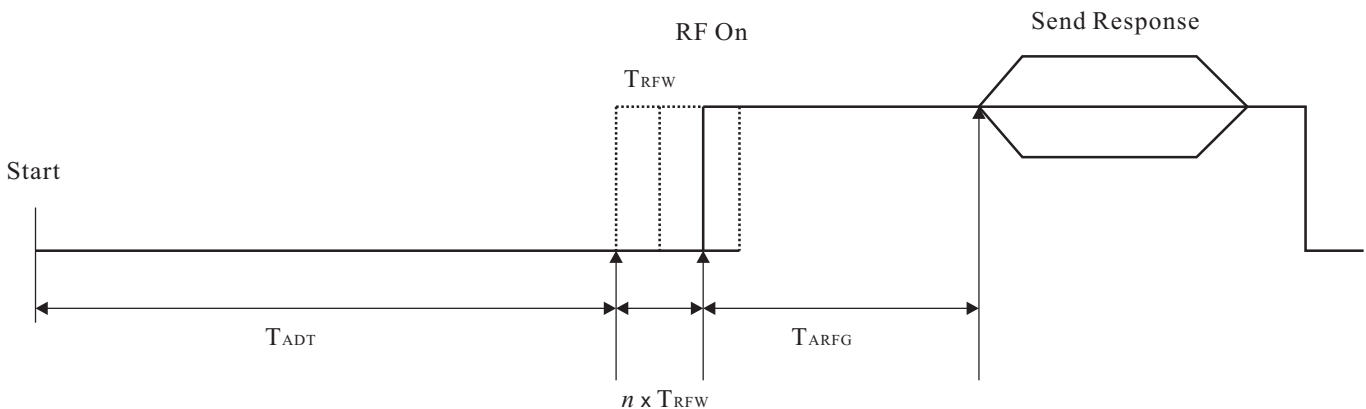

Figure 7 – Response RF Collision Avoidance sequence during activation

T_{ADT} : Active delay time, sense time between RF off Initiator/Target and Target/Initiator.

$$(768/fc \leq T_{ADT} \leq 2\ 559/fc)$$

T_{RFW} : RF waiting time. (512/fc)

n : Randomly generated number of Time Periods for T_{RFW} . ($0 \leq n \leq 3$)

T_{ARFG} : Active guard time between switching on RF field and start to send command. ($T_{ARFG} > 1024/fc$)

11.2 Passive communication mode

11.2.1 Initialisation and Single Device Detection at 106 kbps

11.2.1.1 Frame format and timing

This section defines the frame format and timing used during initialisation and Single Device Detection in passive communication mode at 106 kbps. For bit representation and coding. See 9.3.1.3.

Before the communication starts the initiator has to perform the initial RF Collision Avoidance as described in clause 11.1.1.

Data Frames shall be transferred in pairs, the Initiator initiates the communication followed by the response of the Target.

The Initiator Frame format includes the start of communication, the information and the end of communication. See table 4.

Table 4 – Initiator Frame format

Start of communication (Start)	Information	End of communication (End)
--------------------------------	-------------	----------------------------

- Frame Response time between Initiator and Target.
- The Target frame format includes the start of communication, the information and the end of communication. See table 5.

Table 5 – Target Frame format

Start of communication (Start)	Information	End of communication (End)
--------------------------------	-------------	----------------------------

- Frame Response time Target to Initiator.

The Frame Response time (FRT) from Target to Initiator overlaps the Initiator end of communication.

11.2.1.2 Frame Response Time Initiator to Target

The Frame Response Time is the time between the end of the last pulse transmitted by the Initiator and the first modulation edge within the start bit transmitted by the Target table 6 defines values for n and FRT depending on the command type and the logic state of the last transmitted data bit in this command.

Table 6 – Frame Response Time (Initiator to Target)

Command type	n (integer value)	FRT	
		last pulsed bit = ONE	last pulsed bit = ZERO
SENS_REQ ALL_REQ SDD_REQ SEL_REQ	9	$(n \times 128 + 84) / f_c$	$(n \times 128 + 20) / f_c$
All other commands	≥ 9		

The value $n = 9$ means that all Targets in the field shall respond in a synchronous way which is needed for Single Device Detection. For all other commands the Target shall ensure that the first modulation edge within the start bit is aligned to the bit-grid according to the definition of table 6.

11.2.1.3 Frame Response time Target to Initiator

This is the time between the last modulation transmitted by the Target and the first pause transmitted by the Initiator and shall be at least $1\ 172 / f_c$.

11.2.1.4 Sense Guard Time

The Sense Guard Time is defined as the minimum time between the start bits of two consecutive SENS_REQ commands. It has the value $7\ 000 / f_c$.

11.2.1.5 Frame formats

The following frame types shall be defined as:

- Short Frames for commands defined in 11.2.1.5.1.
- Standard Frames for regular commands in 11.2.1.5.2.
- Bit oriented Single Device Detection frame for SDD_REQ command in 11.2.1.5.3.

11.2.1.5.1 Short frame

A short frame shall be used to initiate communication and consist of, in the following order:

- Start of communication
- 7 data bits transmitted lsb first (for command coding see 11.2.1.16)
- End of communication

No parity bit is added.

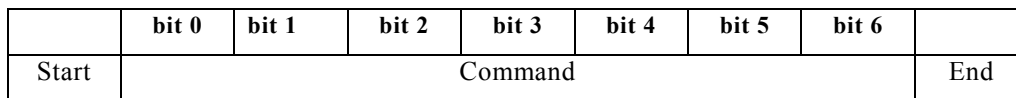

Figure 8 – Short frame

11.2.1.5.2 Standard frame

Standard frames shall be used for data exchange and consist of, in the following order:

- Start of communication.
- $n \times (8 \text{ data bits} + \text{odd parity bit})$. With $n \geq 1$. The lsb of each byte shall be transmitted first. See 11.2.1.16. Each byte shall be followed by an odd parity bit. The parity bit P shall be set such that the number of ONEs is odd in (bit 0 to bit 7, P).
- End of communication.

	Byte 0							Byte 1							..	Byte n							
Start	bit 0	bit 1	..	bit 6	bit 7	P	bit 0	bit 1	..	bit 6	bit 7	P	...	bit 0	..	bit 7	P	End					
	Command or Data							Data							..	Data							

Figure 9 – Standard Frame

11.2.1.5.3 Bit oriented Single Device Detection frame

A collision shall be detected when at least two Targets transmit different bit patterns to the Initiator. In this case the carrier frequency shall be modulated with the subcarrier for the whole bit duration for at least one bit.

Bit oriented SDD frames shall only be used during bit frame SDD and shall in fact for standard frames with a length of 7 bytes, split into two parts:

- Part 1 for transmission from Initiator to Target.
- Part 2 for transmission from Target to Initiator.

For the length of part 1 and part 2, the following rules shall apply:

- Rule 1: The sum of data bits shall be 56.
- Rule 2: The minimum length of part 1 shall be 16 data bits.
- Rule 3: The maximum length of part 1 shall be 55 data bits.

Consequently, the minimum length of part 2 shall be 1 data bit and the maximum length shall be 40 data bits.

Since the split can occur at any bit position within a byte, two cases are defined:

- Case FULL BYTE: Split after a complete byte. A parity bit shall be added after the last data bit of Part 1.
- Case SPLIT BYTE: Split within a byte. No parity bit shall be added after the last data bit of Part 1. The first parity bit from Part 2 is undefined.

The following examples for case FULL BYTE and case SPLIT BYTE define the bit organisation and order of bit transmission.

These examples include proper values for SEL_PAR and BCC.

Standard Frame, split after 3rd complete data byte

	Byte 0	P	Byte 1	P	Byte 2	P	Byte 3	P	Byte 4	P	Byte 5	P	Byte 6	P	
Start	SEL_CMD (93)	1	SEL_PAR (40)	0	Nfcid10 (35)	1	nfcid11 (20)	0	nfcid12 (EF)	0	Nfcid13 (AD)	0	BCC (75)	0	End

Single Device Detection, Part 1: Initiator to Target

Initiator to Target							
	Byte 0	P	Byte 1	P	Byte 2	P	
Start	SEL_CMD (93)	1	SEL_PAR (40)	0	nfcid10 (35)	1	End

Single Device Detection, Part 2: Target to Initiator

Target to Initiator									
	Byte 3	P	Byte 4	P	Byte 5	P	Byte 6	P	
Start	nfcid11 (20)	0	Nfcid12 (EF)	0	nfcid13 (AD)	0	BCC (75)	0	End

Figure 10 – Bit organisation and transmission of bit oriented single device detection frame, case FULL BYTE

Standard Frame, split after 3rd complete byte + 4 data bits

	Byte 0	P	Byte 1	P	Byte 2	P	Byte 3 bits 0-7	P	Byte 4	P	Byte 5	P	Byte 6	P	
Start	SEL_CMD (93)	1	SEL_PAR (40)	0	nfcid10 (35)	1	00000100 (20)	0	nfcid12 (EF)	0	nfcid13 (AD)	0	BCC (75)	0	End

Single Device Detection, Part 1: Initiator to Target

Initiator to Target								
	Byte 0	P	Byte 1	P	Byte 2	P	bits 0-3	
Start	SEL_CMD (93)	1	SEL_PAR (40)	0	nfcid10 (35)	1	0000	End

Single Device Detection, Part 2: Target to Initiator

	bits 4-7	P	Byte 4	P	Byte 5	P	Byte 6	P	
Start	0100	X	nfcid12 (EF)	0	nfcid13 (AD)	0	BCC (75)	0	End

Figure 11 – Bit organisation and transmission of bit oriented single device detection frame, case SPLIT

For a SPLIT BYTE, the first parity bit of part 2 shall be ignored by the Initiator.

11.2.1.6 CRC for 106 kbps

The CRC for the Passive communication mode at 106 kbps is defined in A.1.

11.2.1.7 Target States

The following sections provide descriptions of the States for a Target specific to the bit collision detection protocol.

Targets shall react to valid received frames only. No response shall be sent when transmission errors are detected.

11.2.1.8 POWER-OFF State

In the POWER-OFF State, the Target shall not be powered by the RF field of the initiator due to a lack energy.

If the Target is in an energising magnetic field greater than H_{min} it shall enter its SENSE State.

11.2.1.9 SENSE State

In the SENSE State, the Target is powered. It listens for commands and shall recognise SENS_REQ or ALL_REQ Commands.

The Target enters the RESOLUTION State when it has received a valid SENS_REQ or ALL_REQ Command and transmitted its SENS_RES.

If the Target receives in SENSE State any other valid or invalid command it shall stay in SENSE State.

11.2.1.10 RESOLUTION State

In the RESOLUTION State, the bit frame single device detection method may be applied. Cascade levels are handled inside this State to get the complete NFCID1. See 11.2.1.26.

The Target enters the SELECTED State when it has received a valid SEL_REQ with its complete NFCID1 and sends the SEL_RES back to the initiator.

If the Target receives in the RESOLUTION State any other valid or invalid command it shall fall back to the SENSE State.

11.2.1.11 SELECTED State

In the SELECTED State, the Target shall listen depending on the coding in the SEL_RES to an ATR_REQ command or a valid proprietary command.

The Target shall enter the SLEEP State when a valid SLP_REQ Command is received. In the transport protocol the DSL commands are specified to return the Target to its SLEEP State.

If the Target receives in the SELECTED State any other valid or invalid command it shall fall back to the SENSE State.

11.2.1.12 SLEEP State

In the SLEEP State, the Target shall respond only to an ALL_REQ Command that transits the Target to its RESOLUTION* State.

The Target shall enter the RESOLUTION* State after it has received a valid ALL_REQ Command and transmitted its SENS_RES.

If the Target receives in SLEEP State any other valid or invalid command it shall stay in SLEEP State.

11.2.1.13 RESOLUTION* State

The RESOLUTION* State shall be similar to the RESOLUTION State, a bit frame SDD method can be applied. Cascade levels shall be handled inside this State to get all NFCID1 CL_n .

The Target enters the SELECTED* State when it is selected with its complete NFCID1.

If the Target receives in the RESOLUTION* State any other valid or invalid command it shall fall back to the SLEEP State.

11.2.1.14 SELECTED* State

The SELECTED* State shall be similar to the SELECTED State; the Target shall listen depending on the coding in the SEL_RES to an ATR_REQ command or a valid proprietary command. The Target shall enter the SLEEP State when a valid SLP_REQ Command is received.

In the transport protocol the DSL command are specified to return the Target to its SLEEP State.

If the Target receives in the SELECTED* State any other valid or invalid command it shall fall back to the SLEEP State.

11.2.1.15 Command Set

The commands used by the Initiator and the responses by the Targets are described in table 7.

Table 7 – Command Set

Mnemonic	Definition
SENS_REQ	Sense Request (sent by Initiator)
SENS_RES	Sense Response (sent by Target)
ALL_REQ	Wakeup ALL Request (sent by the Initiator)
SDD_REQ	Single device detection Request (sent by Initiator)
SEL_REQ	Select Request (sent by Initiator)
SEL_RES	Select Response (sent by Target)
SLP_REQ	Sleep Request (sent by Initiator)

11.2.1.16 SENS_REQ and ALL_REQ Command

The SENS_REQ and ALL_REQ Commands shall be sent by the Initiator to probe the field for Targets. They shall be transmitted within a Short Frame.

Particularly the ALL_REQ Command shall be sent by the Initiator to put Targets which have entered the SLEEP State back into the RESOLUTION* State. They shall then participate in further SDD procedures. Table 8 shows the coding of SENS_REQ and ALL_REQ Commands, which use the Short frame format.

Table 8 – Coding of SENS_REQ and ALL_REQ

Short Frame Commands	b6	b5	b4	b3	b2	b1	b0
SENS_REQ	0	1	0	0	1	1	0
ALL_REQ	1	0	1	0	0	1	0
Proprietary	1	0	0	x	x	x	x
Proprietary	1	1	1	1	x	x	x
RFU	All other values						

11.2.1.17 SENS_RES

After an SENS_REQ command is transmitted by the Initiator, all Targets in the SENSE State shall respond synchronously with SENS_RES.

After an ALL_REQ command is transmitted by the Initiator, all Targets in the SENSE or SLEEP State shall respond synchronously with SENS_RES.

The Initiator shall detect any collision that may occur when multiple Targets respond.

11.2.1.18 Coding of SENS_RES

Coding for bit frame single device detection is specified as follows:

Table 9 – Coding of SENS_RES

bit 15	bit 14	bit 13	bit 12	bit 11	bit 10	bit 9	bit 8	bit 7	bit 6	bit 5	bit 4	bit 3	bit 2	bit 1	bit 0
ZERO	ZERO	ZERO	ZERO	Proprietary coding				NFCID1 size bit frame		ZERO	Bit frame single device detection				

- bits b15 to b12 shall be set to ZERO.
- bit b11 to b 8 indicate additional and proprietary coding and shall be ignored on interchange.
- bits b7 and b6 code the NFCID1 size (single, double or triple). See table 10.

Table 10 – Coding of bit 7, bit 6 for bit frame single device detection

bit 7	bit 6	Explanation
0	0	NFCID1 size: single
0	1	NFCID1 size: double
1	0	NFCID1 size: triple
1	1	RFU

- bit 5 shall be set to ZERO
- One out of the five bits b0, b1, b2, b3 or b4 shall be set to ONE to indicate bit frame SDD. See table 11.

Table 11 – Coding of b0 to b4 for bit frame SDD

b4	b3	b2	b1	b0	Meaning
1	0	0	0	0	bit frame SDD
0	1	0	0	0	bit frame SDD
0	0	1	0	0	bit frame SDD
0	0	0	1	0	bit frame SDD
0	0	0	0	1	bit frame SDD

11.2.1.19 SDD_REQ and SEL_REQ Command

These commands shall be used during an SDD. The SDD_REQ and SEL_REQ Commands consist of:

- SEL_CMD (1 byte code; See table 12.)
- SEL_PAR (1 byte code; See table 13 and table 14.)
- 0 to 40 data bits of NFCID1 CL_n according to the value of SEL_PAR.

SEL_CMD specifies the cascade level CL_n.

The SDD_REQ command shall be transmitted within the bit oriented SDD Frame.

The SEL_REQ command shall be transmitted within the Standard Frame.

As long as SEL_PAR does not specify 40 valid bits, the command shall be called SDD_REQ Command, where the Target remains in RESOLUTION or RESOLUTION* State.

If SEL_PAR specifies 40 data bits of NFCID1 CL_n (SEL_PAR =(70)), a CRC shall be appended. This command shall be called SEL_REQ command.

If the Target has transmitted the complete NFCID1, it transits from RESOLUTION State to SELECTED State or from RESOLUTION* State to SELECTED* State and indicates in its SEL_RES response that NFCID1 is complete.

Otherwise, the Target remains in RESOLUTION or RESOLUTION* State and the Initiator shall initiate a new SDD with increased cascade level.

11.2.1.20 Coding of SEL_CMD

Table 12 defines the coding of the SEL_CMD byte.

Table 12 – Coding of SEL_CMD

bit 7	bit 6	bit 5	bit 4	bit 3	bit 2	bit 1	bit 0	Hex notation	Meaning
1	0	0	1	0	0	1	1	(93)	Select cascade level 1
1	0	0	1	0	1	0	1	(95)	Select cascade level 2
1	0	0	1	0	1	1	1	(97)	Select cascade level 3
Other settings are RFU									

11.2.1.21 Coding of SEL_PAR

The length of the SEL_PAR shall be 1 byte. The upper 4 bits shall be called “Byte count” and shall specify the integer part of the number of all valid data bits transmitted by the Initiator (including SEL_CMD and SEL_PAR) divided by 8. Consequently, the minimum value of “Byte count” shall be 2 and the maximum value shall be 7.

Table 13 – Coding of SEL_PAR upper 4 bits

bit 7	bit 6	bit 5	bit 4	Meaning
0	0	1	0	Byte count = 2
0	0	1	1	Byte count = 3
0	1	0	0	Byte count = 4
0	1	0	1	Byte count = 5
0	1	1	0	Byte count = 6
0	1	1	1	Byte count = 7

The lower 4 bits shall be called “bit count” and specify the number of all valid data bits transmitted by the Initiator (including SEL_CMD and SEL_PAR) modulo 8.

Table 14 – Coding of SEL_PAR, lower 4 bits

bit 3	bit 2	bit 1	bit 0	Meaning
0	0	0	0	bit count = 0
0	0	0	1	bit count = 1
0	0	1	0	bit count = 2
0	0	1	1	bit count = 3
0	1	0	0	bit count = 4
0	1	0	1	bit count = 5
0	1	1	0	bit count = 6
0	1	1	1	bit count = 7

11.2.1.22 Coding of SEL_RES

The SEL_RES shall be transmitted by the Target when SEL_PAR has specified 40 valid data bits and when all these data bits match with NFCID1 CL_n. The SEL_RES byte shall be followed by 2 bytes CRC according to A.1.

Byte 0	Byte 1	Byte 2
SEL_RES	CRC	

Figure 12 – Select Response (SEL_RES)

The coding of bit 2 (cascade bit) and b6 is given in table 15.

The coding of bit 6 in SEL shall indicate the NFCIP-1 Target device Attribute Request ability.

Table 15 – Coding of SEL_RES

bit 7	bit 6	bit 5	bit 4	bit 3	bit 2	bit 1	bit 0	Meaning
x	x	x	x	x	1	x	x	Cascade bit set: NFCID1 not complete.
x	1	x	x	x	0	x	x	NFCID1 complete, Target compliant with NFC transport protocol. Request for Attributes supported.
x	0	x	x	x	0	x	x	NFCID1 complete, Target not compliant with transport protocol, Request for Attributes not supported.

11.2.1.23 Select sequence

The purpose of the select sequence is to get the NFCID1 from one Target and to select this Target for further communication.

11.2.1.24 Select sequence flowchart

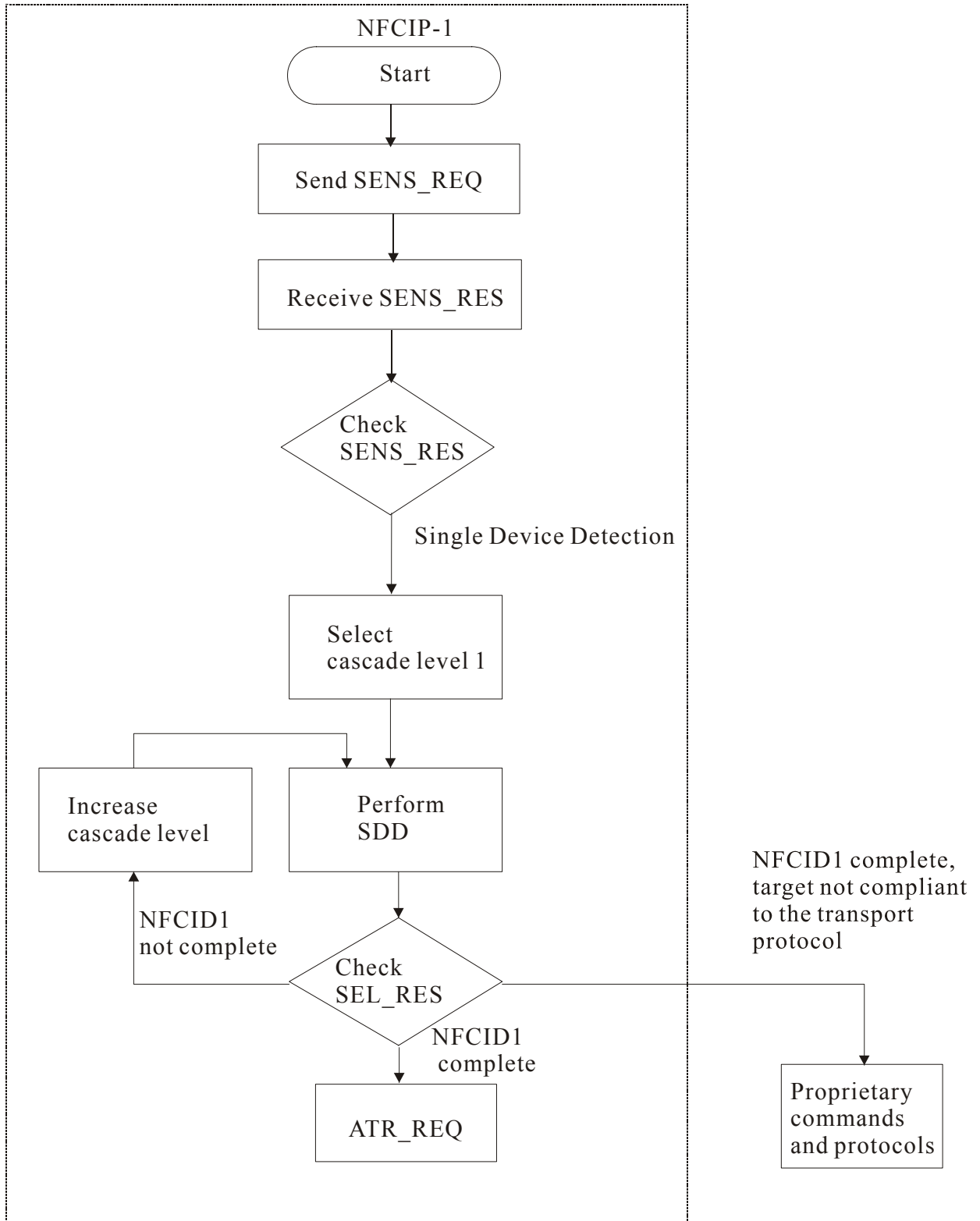

Figure 13 – Initialisation and SDD Flow Chart for Initiator

11.2.1.25 SDD loop within each cascade level

The following algorithm shall apply to the SDD loop: If the NFCID1 of a Target is complete, the Initiator may skip from step 2 to step 10 selecting this Target without performing the SDD loop.

This section describes the bit collision detection protocol applicable for NFCIP-1 device communication at 106 kbps in the Passive communication mode.

The following steps define SDD Flow:

1. The Initiator shall assign SEL_CMD with the code for the selected SDD type and cascade level.
2. The Initiator assigns SEL_PAR with the value of (20). This value shall define that the Initiator will transmit no part of NFCID1 CL_n. Consequently these command forces all Targets in the field to respond with their complete NFCID1 CL_n.
3. The Initiator shall transmit SEL_CMD and SEL_PAR.
4. All Targets in the field shall respond with their complete NFCID1 CL_n
5. Assuming the Targets in the field have a different NFCID1, then if more than one-Target responds, a collision occurs. If no collision occurs, steps 6 to 10 are skipped.
6. The Initiator shall recognise the position of the first collision.
7. The Initiator assigns SEL_PAR with a value that specifies the number of valid bits of NFCID1 CL_n. The valid bits shall be part of the NFCID1 CL_n that was received before a collision occurred followed by a ZERO or ONE, decided by the Initiator. A typical implementation adds a ONE.
8. The Initiator shall transmit SEL_CMD and SEL_PAR, followed by the valid bits itself.
9. Only Targets of which the part of NFCID1 CL_n is equal to the valid bits transmitted by the Initiator shall transmit their remaining bits of the NFCID1 CL_n.
10. If further collisions occur, steps 6 to 9 shall be repeated. The maximum number of loops will be 32.
11. If no further collision occurs, the Initiator assigns SEL_PAR with the value of (70). This value shall define that the Initiator will transmit the complete NFCID1 CL_n.
12. The Initiator transmits SEL_CMD and SEL_PAR, followed by all 40 bits of NFCID1 CL_n, followed by CRC as described in A.1.
13. The Target which NFCID1 CL_n shall match the 40 bits responds with its SEL_RES.
14. If the NFCID1 is complete, the Target shall transmit SEL_RES with cleared cascade bit and transit from RESOLUTION State to SELECTED State or from RESOLUTION* State to SELECTED* State.
15. The Initiator shall check if the cascade bit of SEL_RES is set to decide whether further SDD loop with increased cascade level shall follow.

11.2.1.26 NFCID1 contents and cascade levels

The NFCID1 shall consist of 4, 7 or 10 NFCID1 bytes. Consequently, the Target shall handle up to 3 cascade levels to get all NFCID1 bytes. Within each cascade level, a part of NFCID1 shall be transmitted to the Initiator. According to the cascade level, three types of NFCID1 size are defined. This NFCID1 size has to be consistent with table 16.

Table 16 – Size of NFCID1

NFCID1 size	Cascade level	Number of NFCID1 bytes
single	1	4
double	2	7
triple	3	10

The NFCID1 shall be a random number that is dynamically generated by the Target. The first byte (nfcid10) of the NFCID1 shall assign the content of the following bytes of the NFCID1. See table 17.

Table 17 – Single size NFCID1s

nfcid10	Description
(08)	nfcid11 to nfcid13 is a random number which shall be dynamically generated
(x0) to (x7) (x9) to (xE)	proprietary fixed number
(18) to (F8) (xF)	Set to all ZEROS.

The value (88) of the cascade tag CT shall not be used for nfcid10 in single size NFCID1.

The first byte of the NFCID1 describes the CT in case of double size NFCID1, in case of triple size NFCID1 the CT byte describes the first and the 5th byte of the NFCID1. The cascade tag CT shall be set to (88) in case of double and triple size NFCID1.

Table 18 – Double and triple size NFCID1s

nfcid10	Description
(01)-(7E)	Proprietary
All other values	RFU

In case of double or triple NFCID1s the nfcid10 to nfcid16 or nfcid10 to nfcid19 shall be a random number that is dynamically generated by the Target.

Single size NFCID1

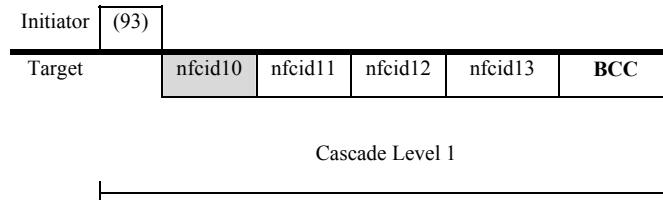

Double size NFCID1

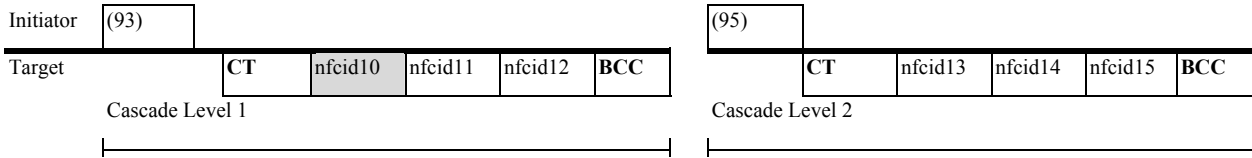

Triple Size NFCID1

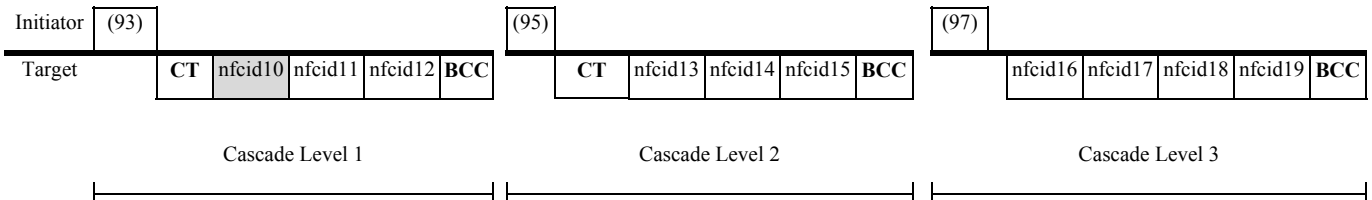

Figure 14 – Usage of cascade levels

The purpose of the cascade tag shall be to force a collision with Targets that have a smaller NFCID1 size. The following algorithm shall apply to the Initiator to get the complete NFCID1:

- The Initiator shall select cascade level 1.
- The SDD shall be performed.
- The Initiator shall check the cascade bit of SEL_RES.
- If the cascade bit is set, the Initiator shall increase the cascade level and initiate a new single device detection.

11.2.1.27 SLP_REQ Command

The SLP_REQ Command consists of two bytes followed by CRC and shall be transmitted within Standard Frame. The CRC is described in A.1.

Byte 0	Byte 1	Byte 2	Byte 3
(50)	(00)	CRC	

Figure 15 – SLP_REQ Command

If the Target responds with any modulation during a period of 1 ms after the end of the frame containing the SLP_REQ command, this response shall be interpreted as ‘not acknowledge’.

11.2.2 Initialisation and SDD at 212 kbps and 424 kbps

11.2.2.1 Start and end of communication

The start of the Passive communication shall be signalled by the presence of modulation of the carrier frequency. The communication shall start with the preamble sequence of minimum 48 bits with all logical “ZERO” encoded. The end of communication shall be forecasted from the Length field of the frame.

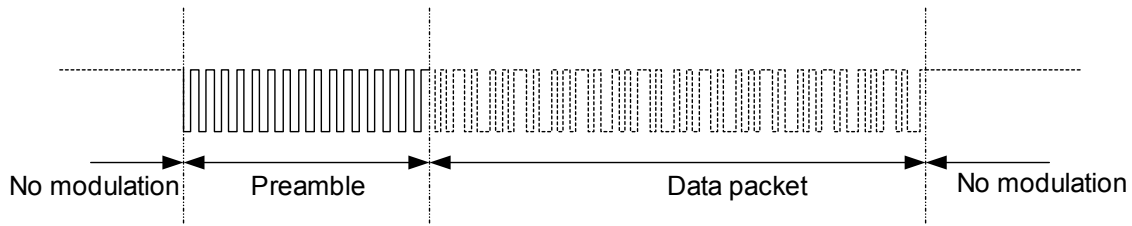

Figure 16 – Start and end of communication

After one NFCIP-1 device has finished communication, the other shall delay for a period of at least $8 \times 64/f_c$ before starting transmission by sending the preamble sequence as shown in figure 17.

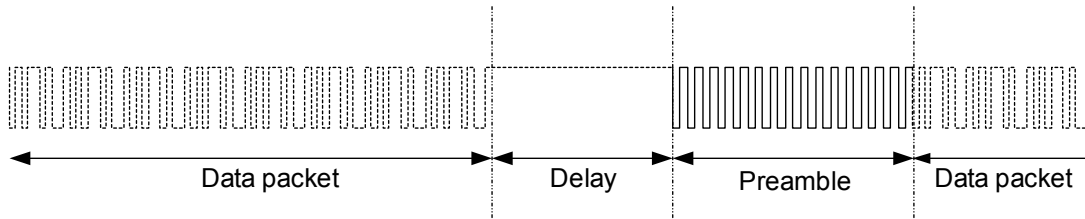

Figure 17 – Delay between frames

11.2.2.2 Frame format

The frame format of shall consist of Preamble, SYNC, Length, Payload, and CRC.

The Preamble shall be 48 bits minimum all logical ZEROS.

The SYNC shall be 2 bytes. The 1st byte of the SYNC shall be (B2) and the 2nd byte shall be (4D).

Preamble	SYNC	Length	Payload	CRC
----------	------	--------	---------	-----

Figure 18 – Frame format

The Length shall be an 8-bit field and it shall be set to the number of bytes to be transmitted in Payload plus 1. The range of the Length shall be 2 to 255, and other settings are RFU.

The Payload shall consist n 8-bit-bytes of data where n is indicated by the number of data bytes.

The CRC shall be calculated according to A.3.

11.2.2.3 Single Device Detection at 202 kbps and 424kbps

The basic technique of the SDD procedure shall be the Time Slot method. The number of the Slot shall be the integer value beyond zero. The Initiator shall send Polling Requests. The Target shall respond at random in each controllable Time Slot. The Initiator shall be able to read NFCID2 data (see 11.2.2.4) of Target(s) in different Time Slots.

After obtaining NFCID2 data from Target(s) in the operating field, the Initiator may communicate with multiple Targets.

Up to 16 Time Slots may be supported by agreement between the interchange parties. The number of Time Slot may be indicated by the value TSN in the Polling Request Frame from the Initiator.

A Target, which is already powered up, responds to the Initiator according to the following rules after receiving the Polling Request Frame from the Initiator.

1. The Target shall generate a random number R in the range 0 to $TSN - 1$.
2. The Target shall wait until the Time Slot is matched to R , then send the Polling Response Frame and wait for the next Request. The Target may ignore a Polling Request to reduce instances of collision of Responses.

The communication between the Initiator and the Target shall be initiated as follows:

1. The Target gets power from the operating field generated by the Initiator.
2. The Target shall become ready for receiving a Polling Request from the Initiator in maximum 2 seconds from power up.
3. The Target shall wait for a Polling Request sent from the Initiator. The Initiator may send a Polling Request without waiting for the Target to become ready.
4. If the Initiator fails to receive Polling Response, then the Initiator may send Polling Request again. The Initiator of the Passive communication mode shall keep RF power on while executing the SDD procedure.

The delay T_d between the end of the Request Frame and the first Time Slot shall be $512 \times 64/f_c$.

The Time Slot unit T_s shall be $256 \times 64/f_c$.

Figure 19 illustrates an example situation of the SDD by Time Slot. In this example, 5 Targets are responding. The Initiator may be able to get the Response information of the Target 2, 4, and 5 excluding 1 and 3. Because a collision has occurred at the Time Slot 1.

The Initiator may repeat SDD procedure.

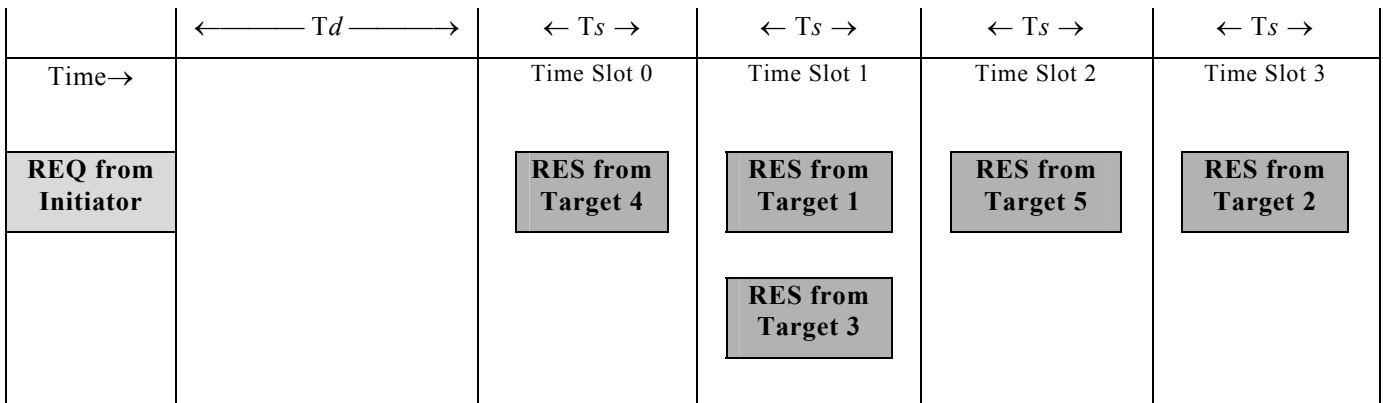

Figure 19 – Single Device Detection by Time Slot

11.2.2.4 NFCID2 contents

NFCID2 shall be an 8-byte number for identifying NFCIP-1 devices. The 2-byte prefix code shall be followed by a 6-byte number in the NFCID2. The prefix code shall define the characteristics for the 6-byte number.

The 6-byte number shall be randomly generated while the prefix code is (01) (FE). Other settings for the prefix code are RFU.

11.2.2.5 Polling Request Frame format

An Initiator for finding Targets shall send polling frame.

Preamble (48 bit min.)	SYNC (16 bit)	Length (8 bit)	Payload					CRC (16 bit)
			(00)	(FF)	(FF)	(00)	TSN	

Figure 20 – Polling Request Frame format

The Preamble shall be 48 bits minimum all logical ZEROS.

The synchronisation (SYNC) pattern shall be 2 byte. The 1st byte of the synchronisation pattern shall be (B2) and the 2nd byte shall be (4D).

The Length shall be set to (06).

The 1st byte of the Payload shall be set to (00).

The 2nd byte and the 3rd of Payload shall be set to (FF) and other settings are RFU.

The 4th byte of Payload shall be set to (00), and other settings are RFU.

The Time Slot Number (TSN) indicates the number of Time Slots plus 1. The TSN shall be (00), (01), (03), (07), or (0F). Any other settings are RFU.

The CRC shall be calculated according to A.3.

Figure 19 illustrates an example where the TSN is (03). If the TSN is set to (00) then only the Time Slot 0 shall be used.

11.2.2.6 Polling Response Frame format

Target shall send the following frame as the Polling Response toward the Polling Request.

Preamble (48 bit min.)	SYNC (16 bit)	Length (8 bit)	Payload			CRC (16 bit)
			(01)	NFCID2	Pad	

Figure 21 – Polling Response Frame format

The Preamble shall be 48 bits minimum all logical “ZERO”.

The synchronisation (SYNC) pattern shall be 2 byte. The 1st byte of the synchronisation pattern shall be (B2) and the 2nd byte shall be (4D).

The Length field shall be set (12).

The start byte of the Payload shall be set to (01). The Payload shall contain 8-byte of NFCID2 and 8-byte of Pad. The Pad shall be ignored for data interchange.

The CRC shall be calculated according to A.3.

11.3 Active communication mode

11.3.1 Initialisation at 106, 212, and 424 kbps

The application switches to Initiator for the Active communication mode and may choose 106 kbps, 212 kbps or 424 kbps.

11.3.2 Active communication mode RF Collision Avoidance

The RF Collision Avoidance shall be executed according to the following timing chart. See figure 22.

- The Initiator shall perform the initial RF Collision Avoidance.
- The first command sends by the Initiator is the ATR_REQ in the Active communication mode at a selected transfer speed.
- The initiator shall switch off the RF field.
- The Target performs the response RF Collision Avoidance.
- The Target sends the ATR_RES as a response to the ATR_REQ in the same transfer speed as it has received the ATR_REQ and switch of the RF field.
- The initiator performs the response RF Collision Avoidance with Time Jitters indicator $n = 0$.
- The Initiator sends the PSL_REQ in order to change parameter or sends the DEP_REQ to start the data exchange protocol.

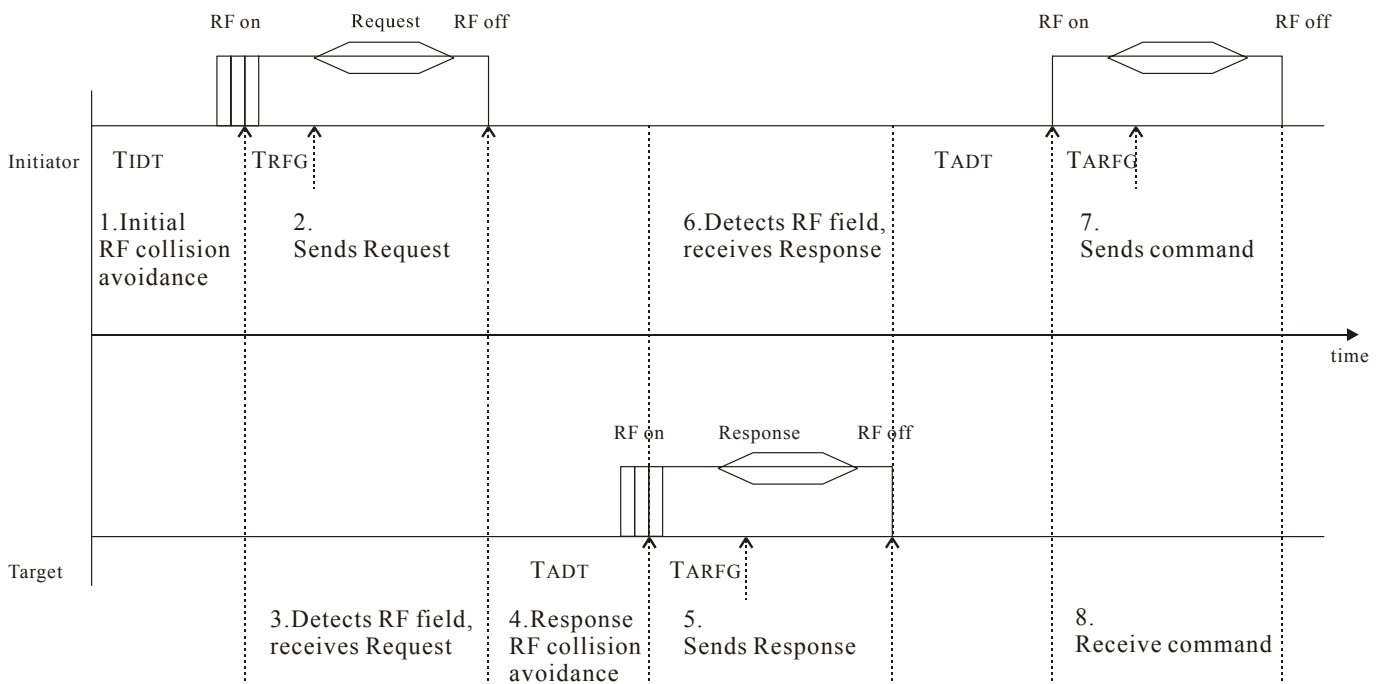

Figure 22 – Initialisation flow for Active communication mode

11.3.2.1 Collision Avoidance for Active communication mode

In case where 2 Targets or more are in the field the one with the lowest *n* will answer first and the other will not answer.

In case of 2 or more Targets answering in exactly the same Time Period, the Initiator will detect a collision and it will re-send the ATR_REQ, which is described in 12.5.1.1.

After the first Target response is detected by the Initiator the Time Jitters parameter indicator *n* shall be set to 0 for further communication.

12 Transport Protocol

The transport protocol shall be handled in three parts

- Activation of the protocol, which includes the Request for Attributes and the Parameter Selection.
- The data exchange protocol, and
- The deactivation of the protocol including the Deselect and the Release.

12.1 Transport Data

User data shall be transported by the Transport Data field in the Frame format. Figure 23 shows the position of the Transport Data field in each Frame format.

The structure for the Frame format for 106 kbps is shown in clause 11.2.1.5.2. The start byte SB shall be set to (F0). The LEN byte shall be set to the length of the Transport Data field plus 1. The range of the LEN shall be in the range of 3 to 255. The E1 is the CRC for the Frame format of 106 kbps as described in A.1. Other settings of LEN are prohibited by this ECMA Standard.

The structure for the Frame format for 212 kbps and 424 kbps as shown in the clause 11.2.2.2 describing the Preamble PA and the Synchronous pattern bytes SYNC.

The LEN byte shall be set to the length of the Transport Data field plus 1. The value of LEN shall be in the range of 3 to 255. The E2 is the CRC for the Frame format of 212 kbps and 424 kbps as described in A.3. Other settings of LEN are prohibited by this ECMA Standard.

The Transport data field contains the mandatory command bytes CMD0 and CMD1 as described in clause 12.4 and the data bytes Byte 0 to Byte n . The content of Byte 0 to Byte n depends on the command byte CMD1 and may contain information. In that case they are mandatory. Data bytes are optional.

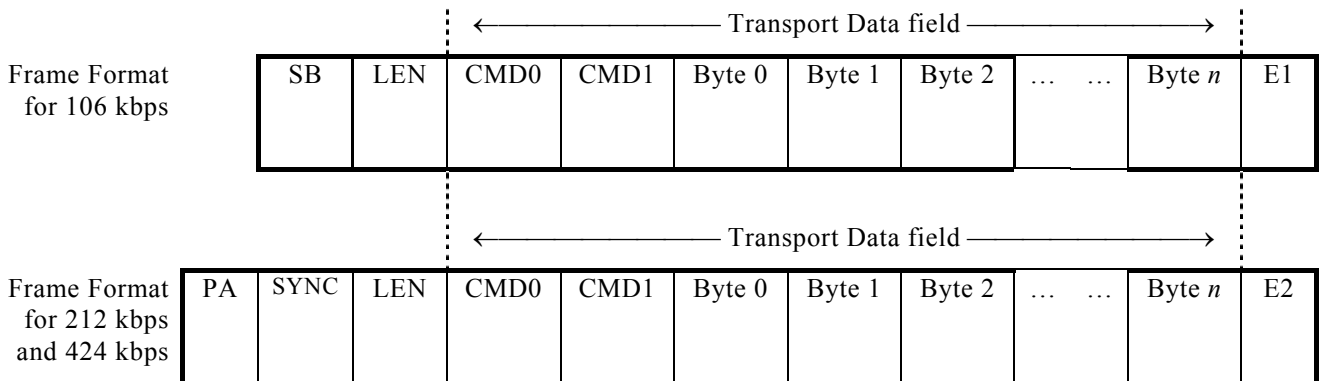

Figure 23 – Transport Frame format Definition

12.2 Passive communication mode Activation flow

The following activation sequence shall be applied:

1. The Initiator shall perform the initial RF Collision Avoidance sequence as defined in clause 11.1.1.
2. The Initiator shall perform the Initialisation and SDD for the Passive communication mode at a chosen transfer speed as defined in clauses 11.2.
3. The support of the NFCIP-1 protocol shall be checked at the different transfer speeds according to the Attribute Request as described in clause 12.5.1.1.
4. The Target may fall back to the Initialisation and SDD if no ATR_REQ is supported.
5. The ATR_REQ may be send by the Initiator as a next command after receiving the Attribute Request is available.
6. The Target shall send its ATR_RES as answer to the ATR_REQ. The Target shall only answer to the ATR_REQ if the ATR_REQ is received directly after selection.
7. If the Target supports any changeable parameter in the ATR_REQ, a PSL_REQ may be used by the Initiator as the next command after receiving the ATR_REQ to change parameters.
8. The Target shall send a PSL_RES as answer to the PSL_REQ.
9. A Target does not need to complement the parameter selection, if it does not support any changeable parameters in the ATR_RES.
10. The transparent data shall be sent using the data exchange transport protocol.

The Initiator activation sequence for a Target in the Passive communication mode is shown in figure 24.

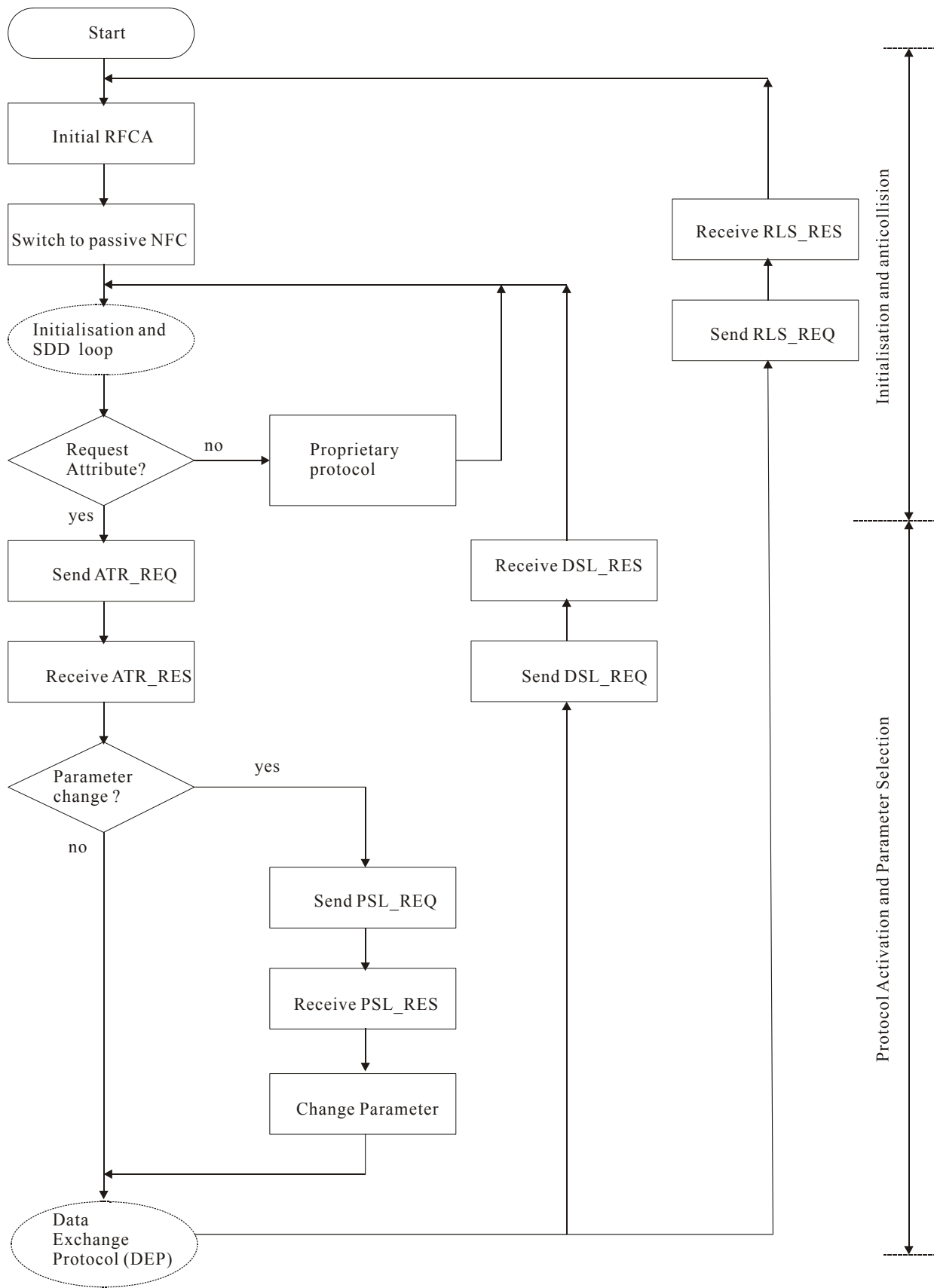

Figure 24 – Activation protocol in Passive communication mode

12.3 Active communication mode Activation flow

The following activation sequence for the protocol in the Active communication mode shall be applied:

1. The Initiator shall perform the initial RF Collision Avoidance sequence as defined in clause 11.1.1.
2. The Initiator shall switch to the Active communication mode and select the transfer speed.
3. The Initiator shall send the ATR_REQ.
4. The Target shall send its ATR_RES in response to the ATR_REQ. After a successful response the device is selected.
5. If the Initiator detects a collision of data the ATR_REQ shall be re-sent.
6. If the Target supports any changeable parameter in the ATR_RES, a PSL_REQ may be used by the Initiator as the next command after receiving the ATR_RES to change parameters.
7. The Target shall send a PSL_RES in response to the PSL_REQ.
8. A Target does not need to complement the parameter selection, if it does not support any changeable parameters in the ATR_RES.

The Initiator activation sequence for a Target in the Active communication mode is shown in figure 25.

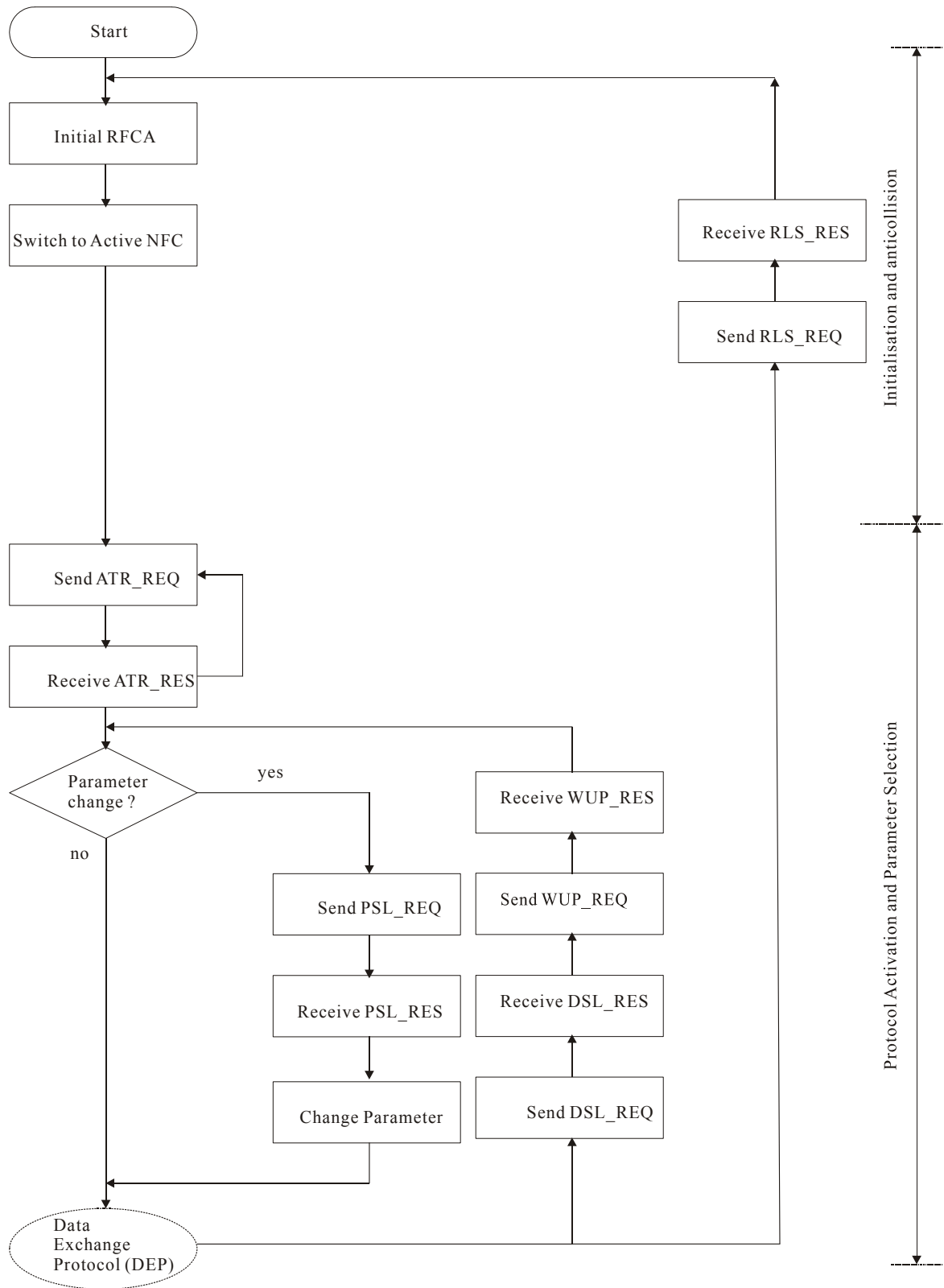

Figure 25 – Activation Protocol in Active communication mode

12.4 Commands

The Command Bytes shall consist of 2 bytes. The first byte shall be CMD0 and the second byte shall be CMD1. The code of the Command Bytes shall specify the Request and Response according to the table 19.

Table 19 – NFCIP-1 Protocol Command Set

Mnemonic	Command Bytes		Definition
	CMD0	CMD1	
ATR_REQ	(D4)	(00)	Attribute Request (sent by Initiator)
ATR_RES	(D5)	(01)	Attribute Response (sent by Target)
WUP_REQ	(D4)	(02)	Wakeup Request (sent by Initiator in Active mode only)
WUP_RES	(D5)	(03)	Wakeup Response (sent by Target in Active mode only)
PSL_REQ	(D4)	(04)	Parameter selection Request (sent by Initiator)
PSL_RES	(D5)	(05)	Parameter selection Response (sent by Target)
DEP_REQ	(D4)	(06)	Data Exchange Protocol Request (sent by Initiator)
DEP_RES	(D5)	(07)	Data Exchange Protocol Response (sent by Target)
DSL_REQ	(D4)	(08)	Deselect Request (sent by Initiator)
DSL_RES	(D5)	(09)	Deselect Response (sent by Target)
RLS_REQ	(D4)	(0A)	Release Request (sent by Initiator)
RLS_RES	(D5)	(0B)	Release Response (sent by Target)

12.5 Activation of the protocol

12.5.1 Attribute Request and Response Commands

12.5.1.1 Attribute Request (ATR_REQ)

This clause defines the Attribute Request ATR_REQ with all its parameter bytes. The Initiator shall send the ATR_REQ to the selected Target.

CMD 0	CMD 1	Byte 0	...	Byte 9	Byte 10	Byte 11	Byte 12	Byte 13	Byte 14	...	Byte n
(D4)	(00)	nfcid3i0	...	nfcid3i9	DIDi	BSi	BRi	PPi	[Gi[0]]	...	[Gi[n]]

Figure 26 – Structure of the ATR_REQ

12.5.1.1.1 Definition of the ATR_REQ bytes

CMD 0: Shall be set to (D4).

CMD 1: ATR_REQ

The ATR_REQ byte shall specify the Attributes Request for the Target. The value of ATR_REQ shall be set to (00).

Byte 0 to Byte 9: NFCID3i

The 10 nfcid3i bytes define the random identifier NCID3i of the Initiator. NFCID3 shall be an ID dynamically generated by the application.

Byte 10: DIDi

The DID byte shall be used for multiple data exchange protocol activation with more than one Target. The range of the DIDi shall be defined between 1 and 14. The value ZERO shall be used, if

no DIDi is used during the data transport protocol. All other values are prohibited by this ECMA Standard.

Byte 11: BSi

The BSi byte shall specify the send-bit rates supported by the Initiator device. The coding of bits is as follows:

bit 7	bit 6	bit 5	bit 4	bit 3	bit 2	bit 1	bit 0
ZERO	ZERO	ZERO	ZERO	DSi	DSi	DSi	DSi

Figure 27 – Coding of the BSi byte

- bit 7 to bit 4: shall be set to ZERO, all other values are RFU.
- bit 3: DSi = 64 supported, if bit is set to ONE
- bit 2: DSi = 32 supported, if bit is set to ONE
- bit 1: DSi = 16 supported, if bit is set to ONE
- bit 0: DSi = 8 supported, if bit is set to ONE

Byte 12: BRi

The BRi byte shall specify the receive-bit rates supported by the Initiator device. The coding of bits is as follows:

bit 7	bit 6	bit 5	bit 4	bit 3	bit 2	bit 1	bit 0
ZERO	ZERO	ZERO	ZERO	DRi	DRi	DRi	DRi

Figure 28 – Coding of the BRi byte

- bit 7 to bit 4: shall be set to ZERO, all other values are RFU.
- bit 3: DRi = 64 supported, if bit is set to ONE
- bit 2: DRi = 32 supported, if bit is set to ONE
- bit 1: DRi = 16 supported, if bit is set to ONE
- bit 0: DRi = 8 supported, if bit is set to ONE

Byte13: PPi

The PPi byte specifies optional parameters used by Initiator device. The coding of bits shall be as follows:

bit 7	bit 6	bit 5	bit 4	bit 3	bit 2	bit 1	bit 0
ZERO	ZERO	LRi	LRi	ZERO	ZERO	Gi	NAD

Figure 29 – Coding of the PPi byte

- bit 7 and bit6: Shall be set to ZERO.
- bit 5 and bit 4: Length Reduction value.

Table 20 – Definition of LRi

LRi	LEN _{MAX}
00	Only Byte 0 to Byte 63 is valid in the Transport Data
01	Only Byte 0 to Byte 127 is valid in the Transport Data
10	Only Byte 0 to Byte 191 is valid in the Transport Data
11	Only Byte 0 to Byte 255 is valid in the Transport Data

- bit 3 and bit 2: Shall be set to ZERO.
- bit 1: If bit is set to ONE then it indicates General bytes is available.
- bit 0: If bit is set to ONE then it indicates the Initiator uses NAD. See 12.6.1.1.1.

Byte 14 to Byte n: Gi[0] to Gi[n]

The general bytes shall be optional and designate general information. The maximum length of the ATR_REQ subtracted by the mandatory bytes give the maximum number of general bytes.

12.5.1.2 Attribute Response (ATR_RES)

This clause defines the answer to request for attributes. The ATR_RES shall be the response to the ATR_REQ and shall be sent by the selected NFCIP-1 Target device.

CMD 0	CMD 1	Byte 0	...	Byte 9	Byte 10	Byte 11	Byte 12	Byte 13	Byte 14	Byte 15	...	Byte n
(D5)	(01)	nfcid3t0	...	nfcid3t9	DIDt	BSt	BRt	TO	PPt	[Gt0]]	...	[Gt[n]]

Figure 30 – Structures of the ATR_RES

12.5.1.2.1 Definition of the ATR_RES bytes

CMD 0: Shall be set to (D5).

CMD 1: ATR_RES

The ATR_RES byte shall specify the Response for the Initiator. The value of ATR_RES shall be set to (01).

Byte 0 to Byte 9: NFCID3t

The 10 nfcid3t bytes define the random identifier NCID3t of the Target. NFCID3 should be an ID generated by the application. The content of NFCID3 may be the same as NFCID1 or NFCID2.

Byte 10: DIDt

The DID byte shall be used for multiple data transport protocol activation with more then one Target. The DIDt shall have the same value as the DIDi. All other values are prohibited by this ECMA Standard. For usage of DIDt see 12.5.1.1.1.

Byte 11: BSt

The BSt byte shall specify the supported transfer speed of the Target device. The coding of bits is defined as follows:

bit 7	bit 6	bit 5	bit 4	bit 3	bit 2	bit 1	bit 0
ZERO	ZERO	ZERO	ZERO	DSt	DSt	DSt	DSt

Figure 31 – Coding of the BSt byte

- bit 7 to bit 4: Shall be set to ZERO.
- bit 3: DSt = 64 supported, if bit is set to ONE
- bit 2: DSt = 32 supported, if bit is set to ONE
- bit 1: DSt = 16 supported, if bit is set to ONE
- bit 0: DSt = 8 supported, if bit is set to ONE

Byte 12: BRt

The BRt byte shall specify the supported receive bit rates of the Target device. The coding of bits is defined as follows:

bit 7	bit 6	bit 5	bit 4	bit 3	bit 2	bit 1	bit 0
ZERO	ZERO	ZERO	ZERO	DRt	DRt	DRt	DRt

Figure 32 – Coding of the BRt byte

- bit 7 to bit 4: Shall be set to ZERO.
- bit 3: DRt = 64 supported, if bit is set to ONE
- bit 2: DRt = 32 supported, if bit is set to ONE
- bit 1: DRt=16 supported, if bit is set to ONE
- bit 0: DRt = 8 supported, if bit is set to ONE

Byte 13: TO

The TO byte shall specify the timeout value of the Target NFCIP-1 device for the transport protocol. The timeout is specified as follows:

bit 7	bit 6	bit 5	bit 4	bit 3	bit 2	bit 1	bit 0
ZERO	ZERO	ZERO	ZERO	WT	WT	WT	WT

Figure 33 – Coding of the TO byte

- bit 7 to bit 4: Shall be set to all ZEROS.
- bit 3 to bit 0: WT: Waiting Time.

The Response Waiting Time (RWT) shall be calculated by the following formula:

$$RWT = (256 \times 16 / fc) \times 2^{WT}$$

Where the value of WT shall be the range from 0 to 14 and the value of 15 is RFU. The default value of WT shall be 4, which gives a RWT value of 4,8 ms.

For WT = 0, RWT = RWT_{MIN} (302 μs)

For WT = 14, RWT = RWT_{MAX} (4 949 ms)

Byte 14: PPt

The PPt byte specifies optional parameters used by Target device. The coding of bits shall be as follows:

bit 7	bit 6	bit 5	bit 4	bit 3	bit 2	bit 1	bit 0
ZERO	ZERO	LRt	LRt	ZERO	ZERO	Gt	NAD

Figure 34 – Coding of the PPt byte

- bit 7 and bit 6: Shall be set to ZERO.
- bit 5 and bit 4: Length Reduction value.

Table 21 – Definition of LRt

LRt	LEN _{MAX}
00	Only Byte 0 to Byte 63 is valid in the Transport Data
01	Only Byte 0 to Byte 127 is valid in the Transport Data
10	Only Byte 0 to Byte 191 is valid in the Transport Data
11	Only Byte 0 to Byte 255 is valid in the Transport Data

- bit 3 and bit 2: Shall be set to ZERO.
- bit 1: If bit is set to ONE then it indicates General bytes available.
- bit 0: If bit is set to ONE then it indicates the Target uses NAD.

Byte 14 to Byte *n*: Gt[0] to Gt[*n*]

The Gt bytes shall be optional and designate general information. The maximum length of the ATR_RES subtracted by the mandatory bytes gives the maximum number of general bytes.

12.5.1.3 Handling of ATR_REQ and ATR_RES

12.5.1.3.1 Initiator rules

When the Initiator has sent the ATR_REQ and receives a valid ATR_RES the Initiator shall continue with operation.

In any other case the Initiator shall retransmit the ATR_REQ before it shall use the deactivation sequence as defined in clause 12.7. In case of failure of the deactivation sequence it may use the SLP_REQ command as defined in clause 11.2.1.27 for Passive communication mode at 106 kbps.

12.5.1.3.2 Target rules

When the Target has been selected by the last command (for passive mode only) and

- a) Receives a valid ATR_REQ, the Target
 - shall send its ATR_RES,
 - shall disable to receive a subsequent ATR_REQ.
- b) Receives any other valid or invalid frame, except a SLP_REQ command for passive communication mode at 106 kbps, the Target
 - shall ignore the block and
 - shall remain in receive mode.

12.5.1.4 Handling of timeout TO

Defined by the initially chosen mode, the communication is either active or passive. The handling of the timeout is different for active and passive communication mode.

12.5.1.4.1 Handling in active mode

In active mode the communication flow is handled by switching the carrier frequency.

Initiator: The Initiator shall ignore a Target that exceeded RWT calculated using TO byte in ATR_REQ from a Target device and continue operation.

Target: The Target shall use a TO value that allows common communication and shall use a supervisory pdu containing a timeout extension to extend the defined RWT. See 12.6.1.1.1.

12.5.1.4.2 Handling of timeout in passive mode

In passive mode the communication is only handled by communication flow. The carrier frequency is not switched.

Initiator: The Initiator shall first use error handling and if no response is received ignores a Target device, that has exceeded the specified timeout and continue communication.

Target: The Target shall use a TO value that allows common communication and shall use a supervisory pdu containing a timeout extension to extend the defined RWT. See 12.6.1.1.1.

12.5.1.5 Handling of DID

12.5.1.5.1 Handling of DID in active and in passive mode.

When the Initiator has sent a ATR_REQ containing a DID equal to ZERO and

- a) received an ATR_RES containing DID equal to ZERO
 - shall send pdu's containing no DID to the Target and
 - shall not activate any other Target while this Target is not deactivated.
- b) received an ATR_RES containing DID not equal to ZERO

- shall continue with error handling

When the Initiator has sent a ATR_REQ containing a DID not equal to ZERO and

- a) received an ATR_RES containing the same DID
 - shall send pdu's containing the DID to the Target and
 - shall not use the DID for any other Targets and
 - shall not use DID=0 for any other Targets.
- b) received an ATR_RES containing any other DID
 - shall continue with error handling.

12.5.2 Wakeup Request and Response Commands

The Wakeup Request and Response commands are only defined for the Active communication mode.

12.5.2.1 Wakeup Request (WUP_REQ)

This clause defines the Wakeup Request for Attributes WUP_REQ with its parameter bytes. The Initiator sends the WUP_REQ to the Target only in the Active communication mode. It shall be applied to reactivate a distinct Target device by its NFCID3, which was deactivated by the DSL command.

CMD 0	CMD 1	Byte 0	...	Byte 9	Byte 10
(D4)	(02)	nfcid3t0	...	nfcid3t9	DID

Figure 35 – Structure of the WUP_REQ

12.5.2.1.1 Definition of the WUP_REQ bytes

CMD 0: Shall be set to (D4).

CMD 1: WUP_REQ

The WUP_REQ byte shall specify the command Wake Up for the Initiator device. The value of WUP_REQ shall be (02).

Byte 0 to Byte 9: NFCID3t

The 10 nfcid3t bytes shall be defined as the random identifier of the Target. For the WUP_REQ command the Initiator shall send the known NFCID3t random identifier to wake up the Target.

Byte 10: DID

The DID byte shall be used for multiple data transport protocol activation with more then one Targets. The range of the DID shall be defined between 1 and 14. The value 0 shall be used, if no DID is used during the data transport protocol. All other values are prohibited by this ECMA Standard. The Initiator may assign a different value to the Target, as used before the last DSL command.

12.5.2.2 Wakeup Response (WUP_RES)

This clause defines the Wakeup Response for attributes WUP_RES. The WUP_RES shall be the response to the WUP_REQ and shall be sent by the selected NFCIP-1 Target device.

CMD 0	CMD 1	Byte 0
(D5)	(03)	DID

Figure 36 – Structure of the WUP_RES

12.5.2.2.1 Definition of the WUP_RES bytes

CMD 0: Shall be set to (D5).

CMD 1: WUP_RES

The WUP_RES byte shall specify the response to the WUP_REQ. The value of WUP_RES shall be (03).

Byte 0: DID

The DID byte shall be used for multiple data exchange protocol activation with more than one Targets. The DIDt shall have the same value as the DIDi. All other values are prohibited by this ECMA Standard.

12.5.2.3 Handling of WUP_REQ and WUP_RES

12.5.2.3.1 Initiator rules

When the Initiator has sent a WUP_REQ and receives a valid WUP_RES the Initiator shall continue with operation.

In any other case the Initiator shall retransmit the WUP_REQ before it shall use the deactivation sequence as defined in clause 12.7. In case of failure of the deactivation sequence for passive mode it may use the SLP_REQ command as defined in clause 11.1.2.19 for Passive communication mode at 106 kbps.

12.5.2.3.2 Target rules

When the Target has been de-selected by the last command (for the Active communication mode only) and

- a) receives a WUP_REQ with its NFCID3, the Target
 - shall send its WUP_RES and
 - shall disable in order to not receive a subsequent WUP_REQ.
- b) receives any other valid or invalid frame, except a SLP_REQ command for passive communication mode at 106 kbps, the Target
 - shall ignore the block and
 - shall remain in receive mode.

12.5.3 Parameter Selection Request and Response Commands

12.5.3.1 Parameter Selection Request (PSL_REQ)

The Initiator may switch parameters for the subsequent transport protocol using the PSL_REQ command.

CMD 0	CMD 1	Byte 0	Byte 1	Byte 2
(D4)	(04)	DID	BRS	FSL

Figure 37 – Structure of the PSL_REQ

12.5.3.1.1 Definition of the PSL_REQ bytes

CMD 0: Shall be set to (D4).

CMD 1: PSL_REQ

The PSL_REQ byte shall specify the command Parameter Selection for the Initiator device. The value of PSL_REQ shall be (04).

Byte 0: DID

The DID shall be similar to the DID defined during ATR or WUP.

Byte 1: BRS

The BRS byte shall specify the selected bit rates for Initiator and Target device.

bit 7	bit 6	bit 5	bit 4	bit 3	bit 2	bit 1	bit 0
ZERO	ZERO	DSI	DSI	DSI	DRI	DRI	DRI

Figure 38 – Coding of the BRS byte

- bit 7 and bit 6: Shall be set to ZERO.
- bit 5 to bit 3: Bit duration of Initiator to Target.
- bit 2 to bit 0: Bit duration of Target to Initiator.

Table 22 – Coding of DRI and DSI

DRI and DSI	Divisor D
000	1
001	2
010	4
011	8
100	16
101	32
110	64
111	RFU

Byte 2: FSL

The FSL byte defines the maximum value for the Frame Length.

bit 7	bit 6	bit 5	bit 4	bit 3	bit 2	bit 1	bit 0
ZERO	ZERO	ZERO	ZERO	ZERO	ZERO	LR	LR

Figure 39 – Coding of FSL bytes

- bit 7 to bit 2: Shall be set to all ZERO.
- bit 1 and bit 0: Length Reduction value.

Table 23 – Definition of LR

LR	LEN _{MAX}
00	Only Byte 0 to Byte 63 is valid in the Transport Data
01	Only Byte 0 to Byte 127 is valid in the Transport Data
10	Only Byte 0 to Byte 191 is valid in the Transport Data
11	Only Byte 0 to Byte 255 is valid in the Transport Data

12.5.3.2 Parameter Selection Response (PSL_RES)

The definition of the frame structure of PSL_RES shall be as follows.

CMD0	CMD1	Byte 0
(D5)	(05)	DID

Figure 40 – Structure of PSL_RES

12.5.3.2.1 Definition of the PSL_RES bytes

CMD0: Shall be set to (D5).

CMD1: PSL_RES

The PSL_RES byte shall specify the command Parameter Selection response for the Target device. The value of PSL_RES shall be (05).

Byte 0: DID

The DID shall be the same as the DID defined during ATR or WUP.

12.5.3.3 Handling of PSL_REQ and PSL_RES

12.5.3.3.1 Initiator rules

The Initiator may change protocol parameters by sending the PSL_REQ to the Target. After reception of a valid PSL_RES, the Initiator

- shall change the framing to the format, which is defined in clause 12.1 and
- shall continue with operation.

In any other case the Initiator may retransmit the PSL_REQ before it shall use the deactivation sequence as defined in clause 12.7. In case of failure of deactivation sequence it may use the SLP_REQ command as defined in clause 11.2.1.27 for the Passive communication mode.

12.5.3.3.2 Target rules

When the Target has received a ATR_REQ, sent its ATR RES and

- a) receives a valid PSL_REQ, the Target
 - shall send its PSL_RES,
 - shall disable the PSL_REQ (stop responding to received PSL_REQ),
 - shall change all parameters to the defined values, which are specified in clause 12.5.3 and
 - shall remain in receive mode.
- b) receives an invalid frame, the Target
 - shall ignore the block ,
 - shall disable the PSL_REQ (stop responding to received PSL_REQ),
 - shall remain with the current framing and

- shall remain in receive mode.
- c) receives a valid frame, except a PSL_REQ, the Target
 - shall disable the PSL_REQ (stop responding to received PSL_REQ),
 - shall remain with the current framing and
 - shall continue operation.

12.6 Data Exchange Protocol

12.6.1 Data Exchange Protocol Request and Response

12.6.1.1 Data Exchange Protocol Request (DEP_REQ) and Response (DEP_RES)

The protocol shall be half-duplex protocol supporting block oriented data transmission with error handling. For data, which does not fit in one frame a chaining mechanism is defined. Format of the protocol frame shall be as follows:

Transport Data field

CMD 0	CMD 1	Byte 0	Byte 1	Byte 2	Byte 3	Byte 4	...	Byte <i>n</i>
-------	-------	--------	--------	--------	--------	--------	-----	---------------

Data Exchange Protocol Header

CMD 0	CMD 1	PFB	[DID]	[NAD]
-------	-------	-----	-------	-------

Transport data bytes

Data byte 0	Data byte 1	...	Data byte <i>n</i>
-------------	-------------	-----	--------------------

Figure 41 – Definition of the protocol frames

In information interchange, the content of the payload of the Transport Data Field requires agreement between the interchanging parties.

12.6.1.1.1 Definition of the Data Exchange Protocol Header bytes

CMD 0:

If the CMD1 is DEP_REQ then the CMD0 shall be set to (D4).

If the CMD1 is DEP_RES then the CMD0 shall be set to (D5).

CMD 1: DEP_REQ

The DEP_REQ bytes specify the command for the data exchange protocol for the Initiator device. The value of the DEP_REQ shall be (06).

CMD 1: DEP_RES

The DEP_RES bytes specify the command for data exchange for the Target device. The value of the DEP_RES shall be (07).

Byte 0: PFB

The PFB byte shall contain bits to control the data transmission and error recovery. The PFB byte is used to convey the information required controlling the transmission. The data exchange protocol defines three fundamental types of pdu's:

- Information pdu's to convey information for the application layer.
- ACK/NACK pdu's to convey positive or negative acknowledgements. An ACK / NACK pdu never contains a data field. The acknowledgement relates to the last received block.
- Supervisory pdu's to exchange control information between the Initiator and the Target. Two types of supervisory pdu's are defined.
 - Timeout extensions containing a 1 byte long data field.
 - Attention containing no data field.

The coding of PFB depends on its type and is defined in the following definitions.

Table 24 – Coding of the PFB bits 7 to 5

bit 7	bit 6	bit 5	PFB
0	0	0	Information pdu
0	1	0	ACK/NACK pdu
1	0	0	Supervisory pdu
Other settings are RFU			

Definition of the Information pdu:

bit 7	bit 6	bit 5	bit 4	bit 3	bit 2	bit 1	bit 0
ZERO	ZERO	ZERO	MI	NAD	DID	PNI	PNI

Figure 42 – Coding of the information pdu

- bit 7 to bit 5: Shall be set to all ZEROs.
- bit 4: If bit set to ONE then it indicates Multiple Information chaining activated.
- bit 3: If bit set to ONE then it indicates NAD available.
- bit 2: If bit set to ONE then it indicates DID available.
- bit 1 and bit 0: PNI packet number information.

The Packet Number Information (PNI) counts the number of packet send by the Initiator to the Target and vice versa starting by 0. These bytes are used for error detection during the protocol handling.

Definition of ACK/NACK pdu:

bit 7	bit 6	bit 5	bit 4	bit 3	bit 2	bit 1	bit 0
ZERO	ONE	ZERO	ACK/NA CK	NAD	DID	PNI	PNI

Figure 43 – Coding of the ACK/NACK pdu

- bit 7: Shall be set to ZERO.
- bit 6: Shall be set to ONE.
- bit 5: Shall be set to ZERO.
- bit 4: If bit set to ONE then it indicates NACK, otherwise ACK.
- bit 3: If bit set to ONE then it indicates NAD available.
- bit 2: If bit set to ONE then it indicates DID available.
- bit 1 and b0: PNI packet number

Definition of the Supervisory pdu (Attention-Target Present, Timeout extensions):

bit 7	bit 6	bit 5	bit 4	bit 3	bit 2	bit 1	bit 0
ONE	ZERO	ZERO	Attention/ Timeout	NAD	DID	ZERO	ZERO

Figure 44 – Coding of the supervisory pdu

- bit 7: Shall be set to ONE.
- bit 6 and bit 5: shall be set to ZERO.
- bit 4: If ATTENTION then set to ZERO. If TIME-OUT_EXTENTION then set to ONE.
- bit 3: If bit set to ONE then it indicates NAD available.
- bit 2: If bit set to ONE then it indicates DID available.
- bit 1 and b0: Shall be set to ZERO.

Byte 1: DID

The DID byte shall be the same as defined during activation of the protocol.

Byte 2: NAD

The NAD byte is reserved to build up and address different logical connections on both the Initiator and the Target device. Bit 7 to bit 4 code the logical address of the Initiator, bits 3 to 0 code the logical address of the Target. The following definitions shall apply for the usage of the NAD.

- The NAD shall only be used for the data exchange protocol.
- When the Initiator uses an NAD, the Target shall also use an NAD.
- If MI bit is set, the NAD shall only be transmitted in the first frame.
- The Initiator shall never use the NAD to address two different Targets.

Byte 3 to Byte n: User data bytes

The data field shall contain the transported data and is optional. When present, it conveys either application data or status information. The length of the data field is calculated by subtracting the mandatory and optional send bytes of the data exchange transport header from the length byte and additionally subtracting one.

12.6.1.2 Handling of Pdu number information

12.6.1.2.1 Initiator rules

The PNI of the Initiator shall be initialized for each Target with all ZEROS.

When an information or acknowledge pdu with an equal PNI is received, the Initiator shall increment the current PNI for that Target before optionally sending a new frame.

12.6.1.2.2 Target rules

The PNI of the Target shall be initialized with all ZEROS.

When an information or acknowledge pdu with an equal PNI was received the Target shall send its response with this PNI and shall increment the PNI afterwards.

12.6.1.3 Handling of Blocks

12.6.1.3.1 General rules

The first pdu shall be sent by the Initiator.

When a data pdus indicating more information is received the pdu shall be acknowledged by an ACK pdu.

Supervisory pdus are only used in pairs. A Supervisory Request shall always be followed by a Supervisory Response.

12.6.1.3.2 Initiator rules

When an invalid pdu was received a NACK pdu shall be sent (except in the case of DSL or RLS).

When a timeout occurs, an attention command shall be sent (except a NACK has been sent before).

When a timeout occurs and a NACK has been sent before, the NACK shall be retransmitted.

When an ACK pdu is received, if its pdu number is equal to the current PNI of the Initiator, the chaining shall be continued.

If the DSL_REQ is not answered by a valid DSL_RES the DSL_REQ may be retransmitted or the Target command ignored.

12.6.1.3.3 Target rules

The Target is allowed to send an RTO pdu instead of a data pdu.

When a data pdu not containing chaining is received it shall be acknowledged by a data pdu.

When an NACK pdu is received, if the PNI is equal to the PNI of the previous sent pdu, the previous block shall be re-transmitted.

When an erroneous pdu is received the Target shall not answer but stay in same State.

When a Supervisory pdu coding an attention command is received, the Target shall respond sending a supervisory attention pdu response.

12.6.2 Response timeout extension

The response timeout extension shall only be used by the Target. When a Target needs more time to process the received block from the Initiator than defined in RWT, it shall use a supervisory pdu using response timeout extension request. A response timeout extension request contains 1 byte long data field. The definition of the byte is shown in figure 45.

Bit 7	bit 6	bit 5	Bit 4	bit 3	bit 2	bit 1	bit 0
ZERO	ZERO	RTOX	RTOX	RTOX	RTOX	RTOX	RTOX

Figure 45 – Coding of Response timeout extension byte

- bit 7 and bit 6: Shall be set to ZERO.
- bit 5 to bit 0: RTOX value.

For RTOX the values 0 and 60 to 63 are RFU. For all other values the intermediate RWT_{INT} shall be calculated by the following formula:

$$RWT_{INT} = RWT \times RTOX$$

The RWT_{INT} starts after the Initiator has sent its RTOX response to the Target. In case RWT_{INT} exceeds RWT_{MAX} , RWT_{MAX} shall be used. The RWT_{INT} is valid until the next frame has been received by the Initiator.

12.6.3 Attention – Target present

The Initiator shall send the attention command to the Target to ensure the Target is still in field for passive mode or to be able to detect a Target loss during multi-activation. This command shall not change the current State of the Target.

The Target shall respond to a valid Attention Request sending an attention command containing the identical data field to the Initiator.

If the Target receives an incorrect pdu it shall not respond and shall stay in the same State.

12.6.4 Protocol operation

After the activation sequence the Target shall wait for a block as only the Initiator has the right to send. After sending a block, the Initiator shall switch to receive mode and wait for a block before switching back to transmit mode. The Target may transmit blocks only in response to received blocks. After responding, the Target shall return to the receive mode.

The Initiator shall not initiate a new pair of Request/Response until the current pair of Request/Response has been completed or if the frame waiting time is exceeded without response.

12.6.5 Multi Activation

The Multi-Activation feature allows the Initiator to hold several Targets active simultaneously. It allows switching directly between several Targets without needing additional time for deactivation of a Target and activation of another Target.

For an example of Multi-Activation see table 25. The Initiator needs to handle a separate package number information for each activated Target.

Table 25 – Multi Activation

Initiator Action	Status Target 1	Status Target 2	Status Target 3
Choose active mode			
Activate Target 1 with DID=1	Selected (1)	Sense	Sense
Any communication with DID=1	Selected (1)	Sense	Sense
...			
Activate Target 2 with DID=2	Selected (1)	Selected (2)	Sense
Any communication with DID=1,2	Selected (1)	Selected (2)	Sense
...			
Activate Target 3 with DID=3	Selected (1)	Selected (2)	Selected (3)
Any communication with DID=1,2,3	Selected (1)	Selected (2)	Selected (3)
...			
Deactivation Sequence with DID=1	Sleep	Selected (2)	Selected (3)
Any communication with DID=2,3	Sleep	Selected (2)	Selected (3)
...			
Deactivation Sequence with DID=2	Sleep	Sleep	Selected (3)
Any communication with DID=3	Sleep	Sleep	Selected (3)
...			
Deactivation Sequence with DID=3	Sleep	Sleep	Sleep
...			

12.6.6 More information (Chaining)

The chaining feature allows the Initiator or Target to transmit information that does not fit in a single block, by dividing the information into several blocks. Each of those blocks shall have a length less than or equal to the maximum frame size (LEN_{MAX}).

The chaining bit in the PFB of a protocol frame control the chaining of frames. Each frame with the chaining bit set shall be acknowledged by an ACK pdu.

The chaining feature is shown in figure 46 using a 16 bytes long string transmitted in three blocks.

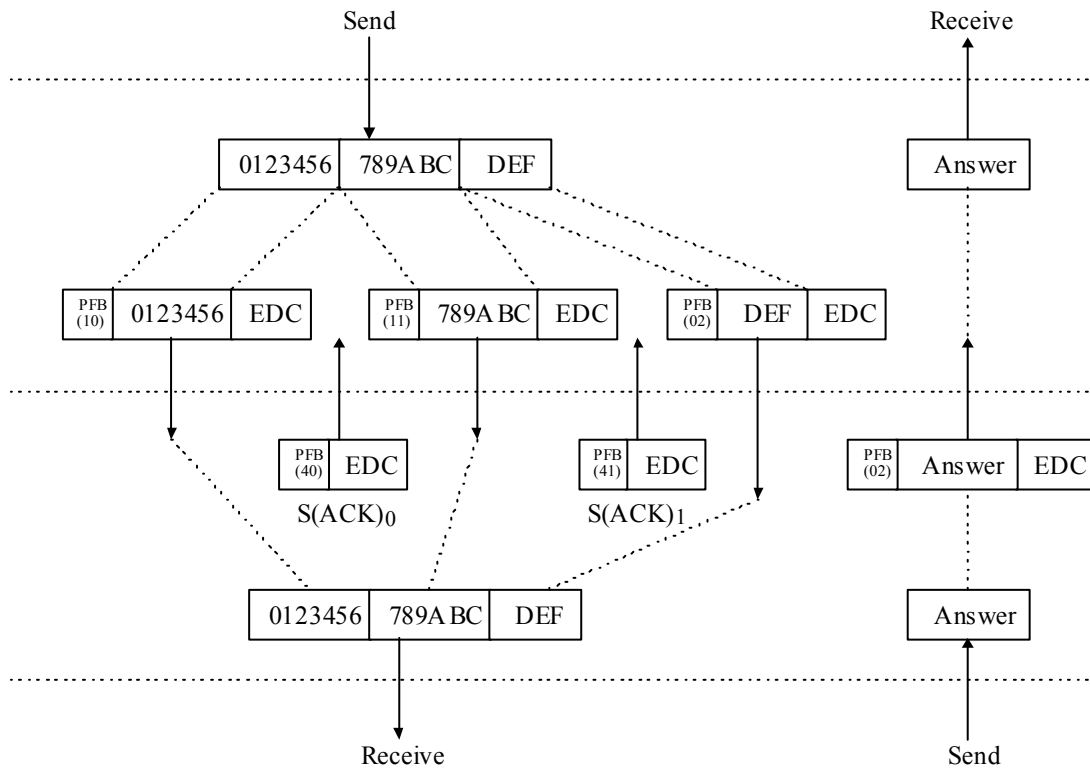

Figure 46 – More Information (Chaining)

12.7 Deactivation of the protocol

After exchange of data by using the data exchange protocol, the Initiator may apply a deactivation of the data exchange protocol. After successful deactivation Initiator and Target shall stay in the initially chosen mode, but the Initiator may choose one of the defined bit rates for reactivation.

The reactivation of Targets is different for passive and active mode and is defined in clause 11.2.1.16 for passive mode and in clause 12.5.2 in active mode.

After successful deactivation the Target shall not respond to subsequent ATR_REQ commands.

The RLS_REQ command shall switch the Target back to POWER ON State. See 12.7.2.1. In this State, the Target shall answer to all initial communication schemes and shall also answer to an ATR_REQ.

12.7.1 Deselect Request and Response command

12.7.1.1 Deselect request (DSL_REQ)

This clause defines the deselect command DSL_REQ. The DSL_REQ is sent from Initiator to the Target.

CMD0	CMD1	Byte 0
(D4)	(08)	[DID]

Figure 47 – Structure of the DSL_REQ

12.7.1.1.1 Definition of DSL_REQ bytes

CMD 0: Shall be set to (D4).

CMD 1: DSL_REQ

The DSL_REQ byte specify the command deselect for the Initiator device. The value of DSL_REQ shall be (08).

Byte 0: DID

The DID shall be the same as defined during ATR or WUP commands.

12.7.1.2 Deselect response (DSL_RES)

This clause defines the Deselect Response command DSL_RES. The DSL_RES is the response to the DSL_REQ and is sent from the Target to the Initiator.

CMD0	CMD1	Byte 0
(D5)	(09)	[DID]

Figure 48 – Structure of the DSL_RES

12.7.1.2.1 Definition of Deselect Response bytes

CMD 0: Shall be set to (D5).

CMD 1: DSL_RES

The DSL_RES byte specifies the command deselect response for the Target device. The value of DSL_RES shall be (09).

Byte 0: DID

The DID shall be the same as in DSL_REQ.

12.7.1.3 Handling of DSL_REQ and DSL_RES

12.7.1.3.1 Initiator rules

When the Initiator has sent a DSL_REQ and received a valid DSL_RES, the Target has been successfully halted. The DID assigned to the Target has been released.

12.7.1.3.2 Target rules

When the Target has received a DSL_REQ and sent its DSL_RES, the Target

- shall stay in initially chosen mode,
- shall enable to receive the default bit rates defined in clause 11.2 for the Passive communication mode and in clause 11.3 for the Active communication mode.
- shall remain in receive mode until a valid ALL_REQ is received in passive communication mode at 106 kbps or a WUP_REQ is received in active communication mode.

12.7.2 Release Request and Response commands

12.7.2.1 Release Request (RLS_REQ)

This clause defines the release command RLS_REQ. The RLS_REQ is sent from the Target to the Initiator.

CMD0	CMD1	Byte 0
(D4)	(0A)	[DID]

Figure 49 – Structure of RLS_REQ

12.7.2.1.1 Definition of RLS_REQ bytes

CMD 0: Shall be set to (D4).

CMD 1: RLS_REQ

The RLS_REQ bytes specify the command release for the Initiator device. The value of the RLS_REQ bytes shall be (0A).

Byte 0 :DID

The DID shall be the same as defined in ATR or WUP commands.

12.7.2.2 Release response RLS_RES

This clause defines the answer to release command the release response command RLS_RES. The RLS_RES is the response to the RLS_REQ sent from the Target to the Initiator.

CMD0	CMD1	Byte 0
(D5)	(0B)	[DID]

Figure 50 – Structure of RLS_RES

12.7.2.2.1 Definition of RLS_RES bytes

CMD 0: Shall be set to (D5).

CMD 1: RLS_RES

The RLS_RES bytes specify the command release for the Target device. The value of the RLS_RES bytes shall be (0B).

Byte 0 :DID

The DID shall be the same as defined in RLS_REQ command.

12.7.2.3 Handling of RLS_REQ and RLS_RES

12.7.2.3.1 Initiator rules

When the Initiator has sent a RLS_REQ and received a valid RLS_RES, the Target has been successfully released. The Initiator may return to initial State.

12.7 2.3.2 Target rules

When the Target has received a RLS_REQ and sent its RLS_RES, the Target shall return to initial State.

Annex A
(normative)

CRC calculation

A.1 CRC for Active and Passive communication mode at 106 kbps

The frame CRC shall be a function of k data bits, which consist of all the data bits in the frame, excluding parity bits, S and E, and the CRC it self. Since data is encoded in bytes, the number of bits k shall be a multiple of 8. For error checking, the two CRC bytes shall be sent in the Standard Frame, after the bytes and before the E.

The CRC shall be calculated by the following polynomial. The pre-set value shall be (6363) and the register content shall not be inverted after calculation.

$$G(x) = x^{16} + x^{12} + x^5 + 1$$

For an example of the CRC calculation for the Active and the Passive mode at 106 kbps. See A.2.

A.2 Example of CRC calculation at 106 kbps

This example is provided for explanatory purposes and indicates the bit patterns that will exist in the physical layer. It is included for the purpose of checking the Passive communication mode implementation at 106 kbps encoding.

The process of encoding and decoding may be conveniently carried out by a 16-stage cyclic shift register with appropriate feedback gates. According to ITU-T Recommendation (ITU-T V.41, Code-independent error control system), Annex I, figures I-1/V.41 and I-2/V.41 the flip-flops of the register shall be numbered from FF0 to FF15. FF0 shall be the leftmost flip-flop where data is shifted in. FF15 shall be the rightmost flip-flop where data is shifted out. Table A.1 defines the initial content of the register.

Table A.1 – Initial content of 16-stage shift register according to value (6363)

FF0	FF1	FF2	FF3	FF4	FF5	FF6	FF7	FF8	FF9	FF10	FF11	FF12	FF13	FF14	FF15
0	1	1	0	0	0	1	1	0	1	1	0	0	0	1	1

Consequently, FF0 corresponds to the msb and FF15 to the lsb.

Examples of bit patterns that will be transmitted via Standard Frames.

Example 1: Transmission of data, first byte = (00), second byte = (00), CRC appended.

Calculated CRC = (1EA0)

First bit transmitted

S	0000 0000	1	0000 0000	1	0000 0101	1	0111 1000	1	E
	(00)	P	(00)	P	(A0)	P	(1E)	P	

Figure A.1 – Example 1 for CRC encoding

Table A.2 – Content of 16-stage shift register according to value (1EA0)

FF0	FF1	FF2	FF3	FF4	FF5	FF6	FF7	FF8	FF9	FF10	FF11	FF12	FF13	FF14	FF15
0	0	0	1	1	1	1	0	1	0	1	0	0	0	0	0

Example 2: Transmission of data block, first byte = (12), second byte = (34), CRC appended.

Calculated CRC = (CF26)

First bit transmitted

S	0100 1000	1	0010 1100	0	0110 0100	0	1111 0011	1	E
	(12)	P	(34)	P	(26)	P	(CF)	P	

Figure A.2 – Example 2 for CRC encoding

Table A.3 – Content of 16-stage shift register according to value (CF26)

FF0	FF1	FF2	FF3	FF4	FF5	FF6	FF7	FF8	FF9	FF10	FF11	FF12	FF13	FF14	FF15
1	1	0	0	1	1	1	1	0	0	1	0	0	1	1	0

A.3 CRC for Active and Passive communication mode at 212 kbps and 424 kbps

The CRC shall be calculated by the CCITT CRC-16, the scope of which shall include the Length field and the Payload field. Calculation in a $G(x)$ shall be defined by:

$$G(x) = x^{16} + x^{12} + x^5 + 1$$

Pre-set value shall be 0. For an example of the CRC calculation for the Active and the Passive mode at 212 kbps and 424 kbps. See A.4.

A.4 Example of CRC calculation at 212 kbps and 424 kbps

The sample Frame is as follows: (00) (00) (00) (00) (00) (00) (B2) (4D) (03) (AB) (CD) (90) (35)

(B2) (4D) is SYNC. (03) is the length. (AB) (CD) is the user data. (90) (35) is the corresponding CRC.

Free printed copies can be ordered from:

ECMA

114 Rue du Rhône

CH-1204 Geneva

Switzerland

Fax: +41 22 849.60.01

Email: documents@ecma.ch

Files of this Standard can be freely downloaded from the ECMA web site (www.ecma.ch). This site gives full information on ECMA, ECMA activities, ECMA Standards and Technical Reports.

ECMA
114 Rue du Rhône
CH-1204 Geneva
Switzerland

See inside cover page for obtaining further soft or hard copies.