



US009175601B2

(12) **United States Patent**
Markoski

(10) **Patent No.:** **US 9,175,601 B2**
(45) **Date of Patent:** **Nov. 3, 2015**

(54) **FLEX FUEL FIELD GENERATOR**

(75) Inventor: **Larry J. Markoski**, Raleigh, NC (US)

(73) Assignee: **INI Power Systems, Inc.**, Morrisville, NC (US)

(*) Notice: Subject to any disclaimer, the term of this patent is extended or adjusted under 35 U.S.C. 154(b) by 193 days.

(21) Appl. No.: **13/343,597**

(22) Filed: **Jan. 4, 2012**

(65) **Prior Publication Data**

US 2013/0168969 A1 Jul. 4, 2013

(51) **Int. Cl.**

- F01N 3/02** (2006.01)
- F02B 63/04** (2006.01)
- F01N 3/10** (2006.01)
- F01N 5/02** (2006.01)
- F02B 5/00** (2006.01)
- F02B 69/02** (2006.01)
- F01N 3/00** (2006.01)
- F02D 19/06** (2006.01)

(52) **U.S. Cl.**

CPC **F02B 63/042** (2013.01); **F01N 3/005** (2013.01); **F01N 3/103** (2013.01); **F01N 5/02** (2013.01); **F02B 5/00** (2013.01); **F02B 63/048** (2013.01); **F02B 69/02** (2013.01); **F02D 19/0615** (2013.01); **F02D 19/0649** (2013.01); **F01N 2590/06** (2013.01); **Y02T 10/16** (2013.01); **Y02T 10/20** (2013.01); **Y02T 10/36** (2013.01)

(58) **Field of Classification Search**

USPC 60/274, 275, 280, 298, 309, 320; 290/1 A, 1 B, 1 R, 2, 40
See application file for complete search history.

(56) **References Cited**

U.S. PATENT DOCUMENTS

D10,647 S	4/1878	Kimberly
1,467,620 A	9/1923	Lindsey
1,573,641 A	2/1926	Hunt
1,792,785 A	2/1931	Burr et al.
1,835,490 A	12/1931	Hesselman
2,211,690 A	8/1940	Edwards
2,503,490 A	4/1950	Robert
2,520,226 A	8/1950	Smith
2,986,135 A	5/1961	Clark et al.
2,995,127 A	8/1961	Orr
3,593,023 A *	7/1971	Dodson et al. 250/430
3,760,781 A	9/1973	Boldt
3,966,330 A	6/1976	Ridler et al.
4,109,193 A	8/1978	Schultheis
4,221,206 A	9/1980	Haas
4,374,508 A	2/1983	Pena
4,386,938 A	6/1983	Earle

(Continued)

FOREIGN PATENT DOCUMENTS

CN	200952429 Y	9/2007
DE	10 2009 052 571 A1	5/2011

(Continued)

OTHER PUBLICATIONS

Honda Owner's Manual Generator EU1000i, 92 pages, (2008).
(Continued)

Primary Examiner — Binh Q Tran

(74) Attorney, Agent, or Firm — Evan Law Group LLC

(57) **ABSTRACT**

A generator system includes (i) an internal combustion engine, (ii) an exhaust gas outlet, connected to the internal combustion engine, for venting exhaust gasses, and (iii) a condenser, connected to the exhaust gas outlet, for condensing water from exhaust gasses.

23 Claims, 5 Drawing Sheets

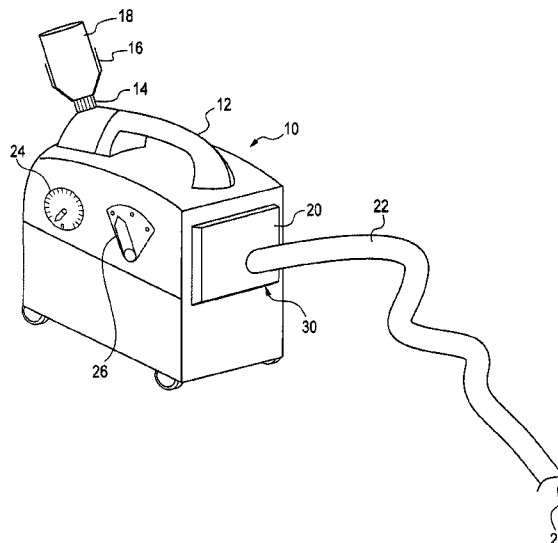

EX1020
HARBOR FREIGHT TOOLS
IPR2025-00805

(56)

References Cited

FOREIGN PATENT DOCUMENTS

U.S. PATENT DOCUMENTS

4,433,548	A *	2/1984	Hallstrom, Jr.	60/712
4,489,680	A	12/1984	Spokas et al.	
4,508,071	A	4/1985	Drenner	
4,548,164	A	10/1985	Ylönen et al.	
D289,033	S	3/1987	Makinson et al.	
4,936,280	A	6/1990	Langlois	
4,968,941	A	11/1990	Rogers	
5,090,967	A	2/1992	Lindström	
5,162,662	A	11/1992	Nakayama	
5,199,397	A	4/1993	Shelef et al.	
D340,565	S	10/1993	Klopfenstein	
5,447,308	A	9/1995	Girard	
5,458,350	A	10/1995	Johnson et al.	
5,555,853	A	9/1996	Bowen et al.	
5,566,745	A	10/1996	Hill et al.	
D379,640	S	6/1997	Gilbert	
5,794,601	A	8/1998	Pantone	
D417,651	S	12/1999	Ohsumi	
D420,465	S	2/2000	Cascio	
6,100,599	A	8/2000	Kouchi et al.	
6,112,635	A	9/2000	Cohen	
D437,825	S	2/2001	Imai	
6,564,556	B2 *	5/2003	Ginter	60/775
6,581,375	B2 *	6/2003	Jagtoyen et al.	60/309
D477,569	S	7/2003	Iwatate et al.	
6,739,289	B2	5/2004	Hiltner et al.	
D518,771	S	4/2006	Xiao	
D520,948	S	5/2006	Xiao	
7,049,707	B2 *	5/2006	Wurtele	290/1 B
D532,748	S	11/2006	Disbennett et al.	
7,161,253	B2	1/2007	Sodemann et al.	
7,183,746	B1	2/2007	Carter	
7,302,795	B2 *	12/2007	Vetrovec	60/309
D594,819	S	6/2009	Yamamoto et al.	
D597,485	S	8/2009	Ma	
7,690,336	B2 *	4/2010	Bowman et al.	123/48 R
7,695,049	B2 *	4/2010	Colborne	296/161
7,765,794	B2 *	8/2010	Alexander	60/285
7,849,680	B2 *	12/2010	Shaff et al.	60/295
7,893,658	B2	2/2011	Bhardwaj	
D633,443	S	3/2011	Wang et al.	
8,061,121	B2	11/2011	Haugen	
D650,739	S	12/2011	Cai	
8,100,093	B2 *	1/2012	Morgenstern	123/3
D662,881	S	7/2012	He et al.	
8,567,354	B2 *	10/2013	Kealy et al.	123/2
8,601,772	B2 *	12/2013	Turpin et al.	53/413
D733,052	S	6/2015	Markoski et al.	
2001/0047777	A1	12/2001	Allen	
2002/0148221	A1	10/2002	Jagtoyen et al.	
2004/0004356	A1	1/2004	Akimoto et al.	
2004/0221828	A1	11/2004	Ries-Mueller et al.	
2010/0019729	A1	1/2010	Kaita et al.	
2010/0201328	A1	8/2010	Monsive, Jr.	
2011/0114068	A1	5/2011	Habing et al.	
2011/0168128	A1	7/2011	Bradley et al.	
2012/0012574	A1	1/2012	Vandrak et al.	
2012/0291420	A1	11/2012	Kim et al.	
2013/0131966	A1	5/2013	Hirano	
2013/0152898	A1	6/2013	Ki et al.	
2013/0158837	A1	6/2013	Jung et al.	
2013/0168969	A1	7/2013	Markoski	
2013/0221684	A1	8/2013	Markoski	
2015/0014998	A1	1/2015	Markoski	
2015/0034025	A1	2/2015	Markoski et al.	

EP	1 069 295	A2	1/2001
EP	1 383 224	A1	4/2002
EP	1 505 709	A2	7/2004
FR	2 815 486		10/2000
FR	2 959 888	A1	5/2010
FR	2 962 002	A1	6/2010
GB	2 184075	A	12/1985
JP	64-32060		2/1989
JP	2010-236301		9/1998
JP	11-190220		7/1999
JP	2001-27128		1/2001
JP	2003-219573		7/2003
JP	2003-293771		10/2003
JP	2003-293788		10/2003
JP	2004-245219		9/2004
JP	2006-188980		7/2006
JP	2008-54442		3/2008
JP	2008-255831		10/2008
JP	2010-20906		1/2010
JP	2010-158129		7/2010
JP	2011-120346		6/2011
JP	2011-252407		12/2011
JP	2012-7508		1/2012
JP	2012-23825		2/2012
JP	2012-34488		2/2012
JP	2010-279107		12/2012
WO	WO 95/26464		10/1995
WO	WO 2011/015731	A1	2/2011
WO	WO 2012/005021		1/2012
WO	WO 2012/011568		1/2012
WO	WO 2013/103532	A1	7/2013
WO	WO 2013/103542	A2	7/2013
WO	WO 2013/130533		9/2013

OTHER PUBLICATIONS

Options for Generators and Welders, located at www.hondapowerequipment.com/pdf/Accessories/ml.repap44a.generators.pdf, 15 pages, downloaded Oct. 1, 2011.

Yamaha Inverter EF2000iS Specifications, located at www.yamahamotor.com/outdoor/products/modelspecs_pdf.aspx?Is=outdoor&mid=626&showprevmodel=0, 1 page, downloaded Oct. 2011.

Yamaha Inverter EF1000iS Specifications, located at www.yamahamotor.com/outdoor/products/modelspecs_pdf.aspx?Is=outdoor&mid=442&showprevmodel=0, 1 page, downloaded Oct. 2011.

Specification of Honda EU1000i, located at www.hondapowerequipment.com/products/modeldetail.aspx?page=modeldetail§ion=P2GG&modelname=EU1000i&modelid=EU1000IKN, 1 page, downloaded Oct. 1, 2011.

Specification of Honda EU2000i, located at www.hondapowerequipment.com/products/modeldetail.aspx?page=modeldetail§ion=P2GG&modelname=EU2000i&modelid=EU2000IKN, 1 page, downloaded Oct. 1, 2011.

Honda Power Equipment Decibels chart, located at www.hondapowerequipment.com/images/dbchart.jpg, 1 page, downloaded Oct. 1, 2011.

"Gasoline", Wikipedia, pp. 1-13, found at <http://en.wikipedia.org/wiki/gasoline>, printed on Dec. 4, 2012.

"Petrol-paraffin engine", Wikipedia, pp. 1-2, found at http://en.wikipedia.org/wiki/petrol-paraffin_engine, printed on Dec. 3, 2012.

Yamaha Generator Owners Manual EF1000iS, 41 pages, 2004.

United Kingdom Search and Examination Report dated Mar. 27, 2013 for GB application No. GB1302360.1, 10 pages.

International Search Report dated Mar. 15, 2013 for PCT application No. PCT/US/2012/070849.

Translation of Japanese Office Action dated Feb. 12, 2015.

Translation of Japanese Office Action dated Mar. 2, 2015.

* cited by examiner

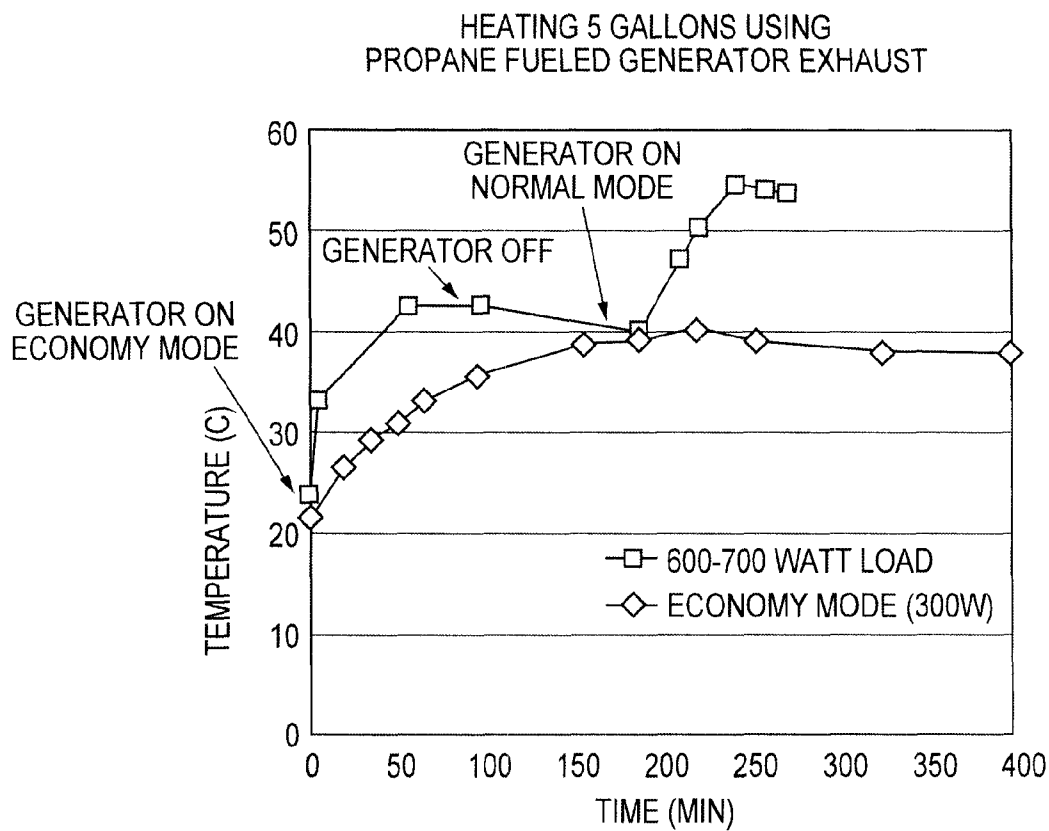
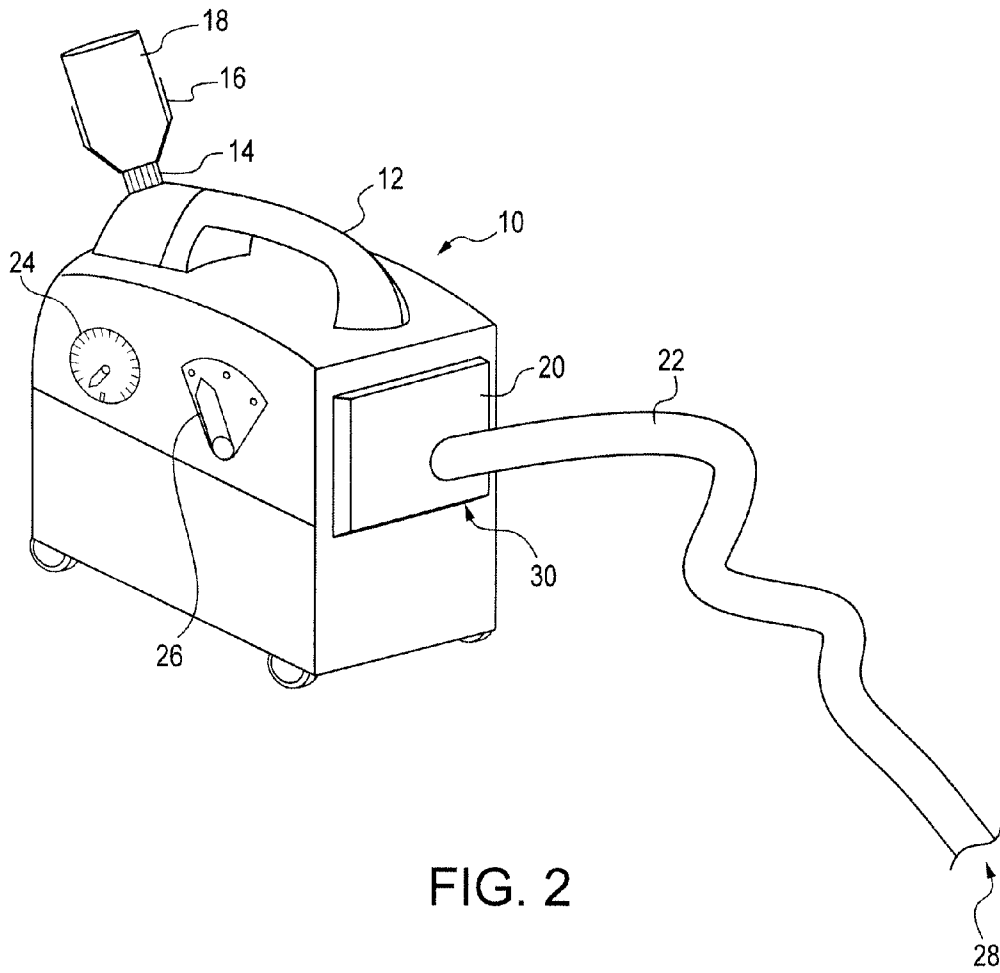

FIG. 1



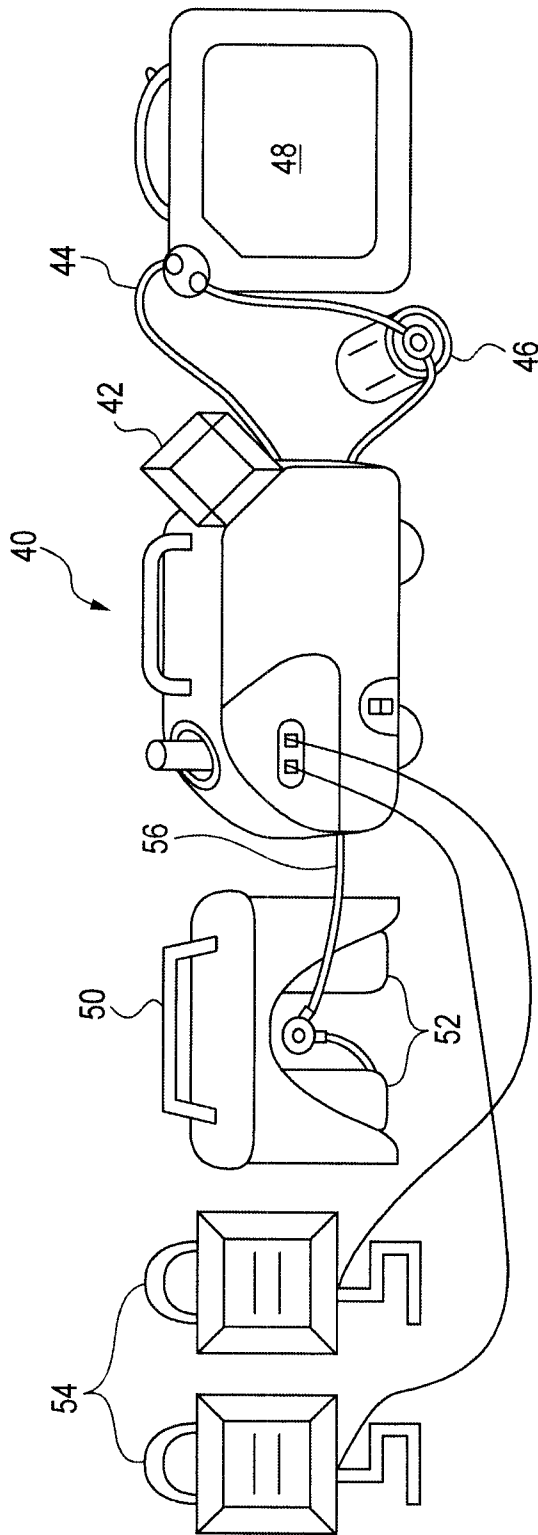

FIG. 3

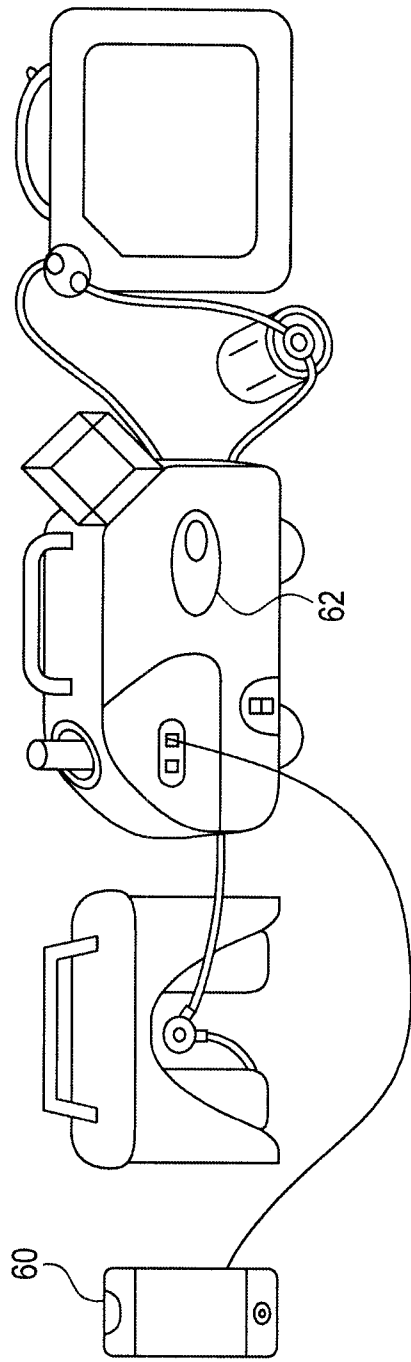

FIG. 4

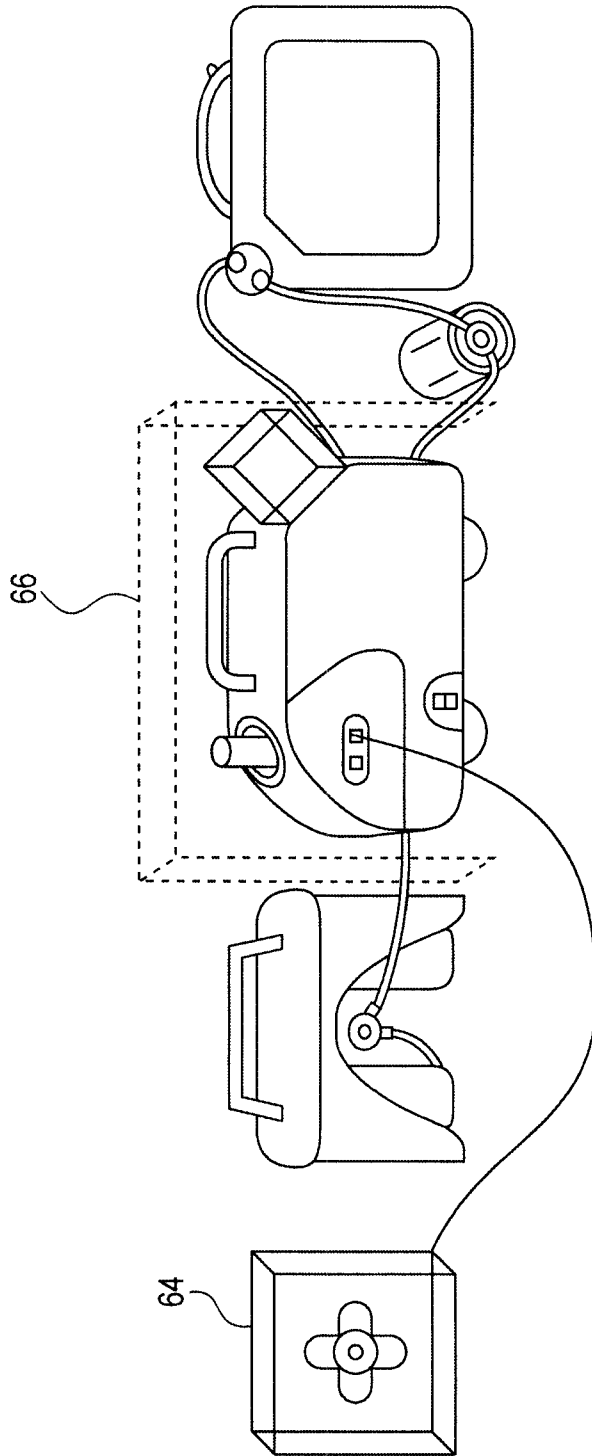

FIG. 5

FLEX FUEL FIELD GENERATOR

BACKGROUND

Portable generators for producing electricity are well known and have been commercially available for many years. These devices typically include an internal combustion engine, are designed to generate sufficient electrical power to run one or more common household or commercial electronic devices, and typically use gasoline as fuel. They are adapted to provide alternating current (AC) electricity, through a standard two-prong or three-prong plug receiver, at 120 or 240 volts, and at 50 to 60 Hz; also common is an additional 12 volt DC power port for charging lead acid batteries. Many of these devices are not fuel injected and include a carburetor and a manual choke. The carburetor mixes the fuel with air before it enters the cylinder. When the engine is first started (cold start), the choke is pulled out (air restricting) to minimize the amount of air mixed with the fuel, so that the cold fuel will combust properly; when the engine warms, the choke is pushed in (air non-restricting) so that the correct amount of air is mixed with fuel for proper combustion at the steady state operating temperature.

Some of the smallest commercially available portable generators include the YAMAHA Inverter EF1000iS and the HONDA EU1000i. The capacity of the fuel tanks in these types of devices is about 0.6 gallons of gasoline, allowing operation at the maximum load of around 1000 W of 4 to 6 hours, or at ¼ load for 8 to 12 hours. These generators produce less noise than larger models, having a typical sound output of 47 to 59 dB. These devices include an internal combustion engine using gasoline fuel, so they necessarily generate carbon monoxide (CO), and do not come equipped with a catalytic converter or CO safety shut down features. Thus the manufactures strongly discourage indoor use because of the danger of carbon monoxide poisoning to humans and animals. Furthermore, the exhaust gases are hot and all metal parts of the device which come into contact with the exhaust gasses also become dangerously hot.

There has been a proliferation of small portable electronic devices in recent years, most of which include small rechargeable batteries. Examples include laptop computers, mobile telephone, personal digital assistants, portable digital cameras and global positioning systems. The rechargeable batteries are most commonly lithium ion batteries, although other varieties are available. The small portable electronic devices typically include a removable power cord with a standard two-prong or three-prong plug, or a universal serial bus (USB) plug, for plugging into a corresponding plug receiver, which allows for recharging the rechargeable batteries. Also commonly available are removable power cords with a standard cigarette lighter plug, for recharging the rechargeable batteries using a cigarette lighter plug receiver in an automobile or other vehicle.

For field operation by consumers of portable appliances such as televisions and radios, and small portable electronic devices and recharging of the batteries therein, portable generators have come into common use. Although an automobile is used to get to the field location for camping or tailgating, and is therefore available for recharging batteries or for providing DC power, unless the engine and alternator are running there is a risk of draining the automobile battery, and compromising the operation or starting capacity of the automobile. If the engine is running, over extended periods of time, there will be substantial use of the gasoline from the fuel storage tank, far in excess of the amount of electricity needed to recharge batteries for small portable electronic devices.

This results because the rechargeable batteries require a specific amount of time and power to recharge, and even when just idling the vehicle engine consumes far more fuel than necessary to recharge the batteries. The advantage of using a portable generator is the much greater efficiency for generating the amount of electricity needed to recharge batteries, over the period of time necessary for recharging, as compared to an automobile engine. In other words, there is a superior match between the power generation and the power consumption. Gasoline for the generator is readily available at retail gasoline refueling stations.

Often, remote field location operations are staged, first setting up a base camp, next a remote camp, and lastly individuals on foot or with only a single vehicle are sent even farther afield. Remote field location operations are therefore required to carry all supplies, especially consumable supplies, which will be needed. Not only is the total amount of supplies often minimized to reduce cost and weight, but the variety of supplies is also minimized, to reduce logistical costs and complexity in transporting materials to, and resupplying, the base camp.

To get to remote field locations, such as those in wilderness areas far away from highways, vehicles which use diesel fuel, rather than gasoline are commonly used. The supplies carried to such remote field locations only include diesel fuel, not gasoline, for the vehicles. In these cases, recharging of batteries is carried out using power generated by the vehicle, keeping the vehicle engine running while recharging the batteries or from a large 2-10 kW diesel generator carried by the vehicle. As noted above, a vehicle engine and alternator is especially inefficient for recharging small batteries. Furthermore, in these remote field locations, the noise generated by the vehicles engine or diesel generator can be especially undesirable, considering the extended period of time needed for recharging batteries. Lastly, unless constantly monitored the vehicle engine or diesel generator will continue running even if the batteries have completed recharging, continuing the consumption of diesel fuel until human intervention or until all of the fuel is consumed. Under these circumstances, the use of diesel fuel and a generator or vehicle engine vehicle alternator is particularly inefficient for recharging small batteries.

To address this inefficient use of diesel fuel in remote field location operations, other energy sources have been used, but each suffers from drawbacks. Solar power units are available, but they tend to be large and require significant set up time to spread out the solar cells for sufficient energy generation. Furthermore, sun light is only available during the day, and unpredictable cloud cover can make the availability of solar power unreliable and intermittent over the time scale of remote field location operations. Wind power is potentially available night and day, but otherwise can require similarly bulky equipment and can be similarly unreliable and intermittent. Finally, for some remote field location operations, such as during extreme weather conditions, it is required to keep all supplies and equipment indoors; neither solar power nor wind power is available indoors, and running the engine of a diesel engine indoors is too dangerous due to carbon monoxide accumulation from the engine exhaust.

In order to address the needs of remote field location operations for small amounts of electrical power over an extended period of time for both the operation of, and recharging of batteries within, small portable electronic devices, small portable generators including an internal combustion engine was considered. However, such devices still suffer from many of the disadvantages of using a vehicle engine or large diesel generator. Although less noisy, they nonetheless generate sig-

3

nificant amounts of noise. Furthermore, indoor operation is also dangerous due to exhaust gases containing carbon monoxide. Although the use of fuel over any specific period of time is less, the small portable generators still continue to run when recharging of batteries is completed unless constantly monitored. A further disadvantage is that an additional fuel, such as gasoline, is needed since small portable generators typically do not use the same fuel as diesel vehicles, complicating the supply logistics by adding to the total amount and variety of materials.

SUMMARY

In a first aspect, the present invention is a generator system, comprising (i) an internal combustion engine, (ii) an exhaust gas outlet, connected to the internal combustion engine, for venting exhaust gasses, and (iii) a condenser, connected to the exhaust gas outlet, for condensing water from exhaust gasses.

In a second aspect, the present invention is a generator system, comprising (1) an internal combustion engine, (2) an exhaust gas outlet, connected to the internal combustion engine, for venting exhaust gasses, (3) a heat exchanger, connected to the exhaust gas outlet, for exchanging heat from exhaust gasses to water, (4) a water tank, (5) a water pump, and (6) hosing, fluidly connecting the heat exchanger, the water tank and the water pump.

In a third aspect, the present invention is a generator system, comprising (a) an internal combustion engine, (b) an exhaust gas outlet, connected to the internal combustion engine, for venting exhaust gasses, (c) a flexible pipe, connected to the exhaust gas outlet, for directing the exhaust gasses, (d) optionally, a carbon monoxide sensor, attached to internal combustion engine, and (e) optionally, a catalytic converter, for reducing carbon monoxide present in exhaust gasses, connected to the exhaust gas outlet. The pipe has a length of at least 5 feet.

In a fourth aspect, the present invention is a method of simultaneously generating electricity and potable water, comprising running a generator including an internal combustion engine, to generate electricity and exhaust gasses, and condensing and collecting water from the exhaust gasses.

In a fifth aspect, the present invention is a method of simultaneously generating electricity and heating water, comprising running a generator including an internal combustion engine, to generate electricity and exhaust gasses, and heating water, with the exhaust gasses, with a heat exchanger.

In a sixth aspect, the present invention is an improved method of setting up a remote field location operation, including transporting personnel, diesel fuel, portable electronics, rechargeable batteries, water, and food, in a diesel fuel powered vehicle, the improvement comprising further transporting a generator including an internal combustion engine and a condenser, and replacing a portion of the water with fuel for the generator.

In a seventh aspect, the present invention is an improved method of operating a remote field location operation, including recharging rechargeable batteries with a diesel vehicle engine, the improvement comprising recharging rechargeable batteries with a generator including an internal combustion engine. The generator operates with rubbing alcohol as fuel, and the rubbing alcohol is supplied in bottles, each bottle containing a unit measure of rubbing alcohol.

In an eighth aspect, the present invention is a method of generating electricity with a gasoline or propane generator

4

having a choke, comprising operating the generator with a fuel consisting essentially of an alcohol, wherein the fuel does not comprise gasoline.

DEFINITIONS

A gasoline or propane generator is a generator including a carburetor and manual choke, which operates most efficiently using gasoline or propane, respectively, when the choke is placed in the fully open position, after the generator has been started.

BRIEF DESCRIPTION OF THE DRAWINGS

FIG. 1 is a graph showing the amount of time required to heat water using waste heat from a generator.

FIGS. 2-5 illustrate remote field generators.

DETAILED DESCRIPTION

The present invention makes use of a variety of discoveries which individually, in combination, and in a multitude of permutations, adapt and improve a commercial generator including an internal combustion engine for remote field location operations, and furthermore add and extend functionality, including reducing logistical burdens. Adaptations for remote field location operations include one or more of the following: (a) a condenser for collecting water from exhaust gasses; (b) a heat exchanger and liquid pump for the continuous generation of pasteurized or hot water for drinking, bathing or showering; (c) a flexible pipe for transporting exhaust gasses, which may include carbon dioxide and carbon monoxide, away from the generator (which may be indoors or in a tent) to a location away from the users (such as outside or into a body of water); (d) a catalytic converter for reducing carbon monoxide of the exhaust gasses; (e) a carbon monoxide sensor for detecting dangerous levels of carbon monoxide; (f) a ventilation fan for improving ventilation and reducing the local concentration of carbon dioxide and/or carbon monoxide; (g) a cover for protecting the generator from rain; (h) a timer for selecting an amount of time for the generator to run before automatically turning off; (i) a fuel selector for adjusting settings of the generator for optimal operation of any one of a variety of liquid or gaseous fuels; (j) a bottle adaptor for holding and dispensing a liquid fuel from a unit measure in a bottle of liquid fuel, such as rubbing alcohol; and (k) a hot swap, for exchanging gaseous fuel tanks without interrupting the supply of gaseous fuel. Furthermore, if the remote field generator is operated with rubbing alcohol, in unit measures, then it may provide the logistical advantage of not requiring the transport or supply of a unique fuel for the generator.

Generators including an internal combustion engine produce exhaust which includes water vapor, carbon dioxide, partially oxidized fuel and small amounts of carbon monoxide. A water condenser may be attached to the exhaust, to reduce the thermal signature and condense and capture the water vapor as liquid water. Since the water is condensed from the gas phase, the water is clean and free of microorganisms, and is therefore potable, and may be used for drinking or bathing. If small amounts of fuel or engine oil contaminate the water, it may be further cleaned through the addition of a catalytic converter and/or filtered with an activated carbon water filter. Since most hydrocarbon fuels and alcohols contain a ratio of hydrogen to carbon of about 2:1, the weight of water produced by condensing water from exhaust gasses of the generator is about the same as the weight of fuel

5

consumed. Inclusion of a water condenser therefore provides a dramatic logistic advantage: rather than transport both fuel and water, only fuel need be transported to the remote field location, since the fuel may be converted to an equal weight of water by using the fuel in the generator.

A water condenser functions as a heat exchanger, by removing heat from the exhaust gasses. Once the temperature of the water vapor in the exhaust is below the boiling point of water, the water vapor will condense to form liquid water. The heat may be transferred to air, or may be transferred to additional liquid water pumped through the condenser or heat exchanger. In a remote field location both the hot air and hot water produced by the heat exchanger may be used: hot air may be used to provide heat to maintain the temperature inside a tent or structure, and hot water may be used for bathing or showering or pasteurizing locally obtained water. In either case, a logistical advantage is obtained, since there is no need to carry extra fuel or equipment for heating air, or extra fuel or equipment for heating water for cooking, bathing, showering and/or drinking. In the case of transferring the heat to water, a water pump may be used to circulate the water through the heat exchanger or condenser, to and from a tank of water. Similarly, water produced by the condenser may be stored in a tank, and a pump may be used to transport the water to or from the tank or from one tank to another. The water pump may be operated through an electrical port, such as a 12 V DC port, on the generator. The inclusion of a condenser or heat exchanger also provides a substantial reduction in the noise produced by the generator, in effect, acting as a muffler for the engine. A typical remote field generator may heat 5 gallons of water to 45° C. in about one hour (FIG. 1).

In another configuration, water from an additional water source, such as a well, river or tank, could be passed through the heat exchanger at a rate slow enough to achieve a specific temperature upon exiting the heat exchanger, for example at 90° C. This would avoid the need to completely heat a tank of water, greatly reducing the time need to heat a small amount of water to a desired temperature, for example for showering, cooking, or simply to pasteurize water from the water source for drinking in a single pass.

For use of a generator indoors, for example inside a tent or building where the electricity, hot air and/or hot water produced by the generator would be consumed, the oxidation products of the internal combustion process including carbon dioxide, carbon monoxide, and some trace organics of the exhaust gasses are of concern. Extended build up of carbon dioxide, which could displace oxygen in air, may cause suffocation. Furthermore, accumulation of carbon monoxide, even in small amounts, is poisonous to humans and animals. To address this problem, a pipe may be connected to the exhaust, for carrying exhaust gasses from the generator to an outdoor location. The pipe may be of any length sufficient to extend from the generator to an outdoor location, through an opening in a tent, or through a window or door, or another small opening, of a building or structure. For example, the pipe may be 5, 10, 20, 50 or 100 feet long. The pipe may be made of plastic, rubber, or even metal. Preferably, the pipe is flexible and/or elastic, such as silicone rubber. Preferably, the pipe has a wall thickness of at least 1/8 of an inch, such as 1/4 to 1 inch, including 3/8, 1/2, 5/8, 3/4, and 7/8 of an inch. Additional foam or padding may cover the pipe, to further reduce noise from the generator. Furthermore, a water condenser or heat exchanger may be located between the generator and the pipe, or may be attached to the end of the pipe away from the generator. The end of the pipe away from the generator may be placed underground or into a body of water (such as a lake,

6

river or stream) to further dampen noise and reducing the amount of heat released with the exhaust gasses.

Additional features may be included to minimize the risk of poisoning due to carbon monoxide. For example, a catalytic converter may be included, located between the generator and the pipe, or may be attached to the end of the pipe away from the generator. The catalytic converter may catalyze the reaction of carbon monoxide and/or trace organics, with oxygen to produce carbon dioxide, reducing the total amount of carbon monoxide produced.

A carbon monoxide sensor may also be included with the generator, for detecting the level of carbon monoxide or carbon dioxide near the generator. The detector may set off an alarm when the level of carbon monoxide approaches, or reaches, a dangerous concentration. In addition to an alarm, or instead of an alarm, the carbon monoxide detector may be connected to the generator and cause the generator to turn off when the level of carbon monoxide approaches, or reaches, a dangerous concentration. Additionally, a ventilation fan, optionally connected to the carbon monoxide sensor, may also be included to provide additional ventilation and help prevent carbon monoxide poisoning. The ventilation fan may be operated from electricity produced by the generator.

During remote field location operations, it may be desirable or necessary to operate the generator outdoors. In order to protect the generator from damage from rain, a cover or sleeve may be placed over or around the generator. A cover may be as simple as a small umbrella with a self-supporting stand, protecting the generator from rain. Alternatively, or in addition, the electronics of the generator may be sealed with a polymeric material, such as silicone rubber or expanded poly(perfluoroethylene) (also known as Teflon®), to prevent water from entering the generator. In addition the sealing material may also provide a sound dampening function.

During operation, the generator may become hot. A heat shield, such as insulation or a heat reflective coating, may cover or surround the generator, keeping the heat inside the device and expelling additional heat through the exhaust gasses. A water cooled cover may also be used to remove heat from the generator. When used with an insulated pipe, the heat may be expelled with the exhaust gasses far away from the generator itself. The insulation or heat shield may also serve to further dampen noise created by the generator during operation. A noise cancellation device, which measures the sound created by the generator and then broadcasts sound which will cancel the sound created by the generator, may also be included. Such a noise cancellation device may be powered by electricity produced by the generator.

In order to avoid wasting fuel, the generator should be turned off once the task, such as recharging batteries, has been completed. However, having a person monitor the generator and the task can be inconvenient. A timer may be attached to the generator, which is connected to the generator and turns the generator off, after a preset amount of time has passed. The timer may have various settings for specific amounts of time, and/or settings labeled for specific tasks, such as recharging batteries; the task specific settings maintain operation of the generator for a predetermined amount of time necessary to complete the task. Alternatively, an amount of liquid fuel just sufficient to operate the generator for a length of time necessary to complete the task may be placed into the fuel tank of the generator, causing the generator to stop when the fuel is consumed, which would correspond to the amount of time necessary to complete the task. For example, a unit measure of fuel, such as 500 ml of rubbing alcohol, will cause a generator to run for the correct amount of time to recharge a set of lithium ion batteries. Lastly, the fuel tank of the

7

generator could be sized at the volume necessary for a specific task, such as recharging batteries, for example at 500 ml.

It is known that alcohols, such as methanol and ethanol can be used to operate an internal combustion engine. However, small commercial portable generators built for using gasoline or propane as fuel, particularly those which include a carburetor and a choke, do not run properly using alcohols as fuels. The internal combustion engine will begin running with the choke closed using alcohols as fuels, but once it begins to heat up and the choke is opened, the engine will stall or run very inefficiently—the revolutions per minute (RPM) of the engine will be far lower than it would run using gasoline or propane.

Surprisingly, placing the choke into an intermediate position, between open and closed, will allow the engine to run efficiently using alcohols, as well as other fuels. It was unexpectedly discovered that allowing less air into the carburetor than when using gasoline or propane as fuel will provide efficient running of the engine on non-gasoline and non-propane fuels. It can be determined exactly which position the choke should be placed, by gradually moving the choke from closed to open after starting the engine; the correct position is determined by maximizing the RPM of the engine while moving the choke, either by observing the RPM of the engine directly with a tachometer, or by listening to the speed of the engine. In this way, fuels, such as alcohol, may be used to efficiently operate a gasoline or propane generator.

Similarly, small commercial portable generators built for using gasoline or propane as fuel, particularly those which include a carburetor and a choke, do not run properly using diesel fuel. Surprisingly, it has been discovered that if the generator is started using a gaseous feed fuel such as propane, for example, then the fuel feed may be switched to liquid diesel fuel when the engine has heated up to a temperature of about 100 to 125° C. At a temperature of about 100 to 125° C. the diesel fuel is easily vaporized; such temperatures may be quickly attained by limiting the cooling of the engine.

A fuel selector, including settings for different fuels, may be present on the generator. The fuel selector adjusts the generator, such as adjusting the amount of air mixed with fuel via a choke to optimally operate with the fuel selected, or start or stop a fuel pump when switching between fuels. Different fuels include liquid fuels, such as gasoline; diesel fuel; alcohols including methanol, ethanol and propanol, for example 70% or 91% isopropanol and water, isopropanol/ethanol mixtures, ethanol with a denaturing agent, including 95% ethanol and water with a denaturing agent; aldehydes and ketones, such as acetone, which may also be present as mixtures with water and/or alcohols; and mixtures of liquid fuels; and gaseous fuel including hydrogen, syngas, biogas, methane (such as natural gas), ethane, propane, butane and mixtures thereof.

A particularly preferred liquid fuel is rubbing alcohol, which includes both 91% and 70% isopropanol and water, isopropanol/ethanol/water mixtures, ethanol with a denaturing agent, including 95% ethanol and water with a denaturing agent. Rubbing alcohol is prepackaged into bottles, referred to as unit measures, typically having a volume of 1 pint, 1 quart, 500 ml, or 1000 ml. Rubbing alcohol is a medical product used to sterilize and clean medical equipment and as an antiseptic on the skin surface for disinfecting minor cuts and abrasions. Surprisingly, both 91% and 70% isopropanol and water is useful as a fuel in an internal combustion engine, in spite of the high water content. Furthermore, it is a very safe fuel: even when ignited in free liquid form, the combustion temperature is low enough that it rarely causes damage to skin and is readily extinguished with and soluble with water. Rubbing alcohol is generally included in medical supplies for

8

remote field location operations, thus avoiding an increase in the logistical burden when used as a fuel for a generator. Other liquid fuels, such as methanol, ethanol, isopropanol, and butanol, may also be packed as unit measures of fuel, such as a bottle having a volume of 1 pint, 1 quart, 500 ml, or 1000 ml.

A bottle adaptor, adapted to receive a bottle having a volume of 1 pint, 1 quart, 500 ml, or 1000 ml, may be attached to the fuel port of the generator. The bottle adaptor may be, for example, a wide-mouth funnel, with an opening large enough to fit the bottle opening, and sides with a greater width than the width of the bottle and extending more than half the length of the bottle. With such an adapter, a bottle of rubbing alcohol may be opened and placed into the adaptor, so that all the liquid will drain into the fuel tank of the generator.

In the case of gaseous fuel, the fuel inlet may be connected to a hot swap. A hot swap is an adapter which allows a new gas tank containing fuel to be attached to the generator before a current gas tank is disconnected. In this way, the generator will continue to operate when gas tanks are changed, and the fuel supply will not be interrupted.

FIG. 2 illustrates a remote field generator including aspects of the present invention. An internal combustion generator 10 includes water condenser 20 attached to the exhaust outlet 30, and a pipe 22 connected to an outlet of the condenser for directing the exhaust gasses 28 away from the generator. A timer 24 may be set by a user to a variety of setting, which variably controls the amount of time of operation of the generator. A fuel selector 26 may be set to different settings pre-calibrated for optimizing the operation of the generator for different fuels. A fuel inlet 14 includes a bottle adapter 16 for holding a bottle 18 and dispensing the contents of the bottle into the fuel tank of the generator. Also illustrated is a handle 12 for carry the generator by hand.

FIG. 3 illustrates a remote field generator including aspects of the present invention. An internal combustion generator 40 includes a heat exchanger 42 connect to the exhaust gas exit of the internal combustion generator. The heat exchanger uses water as a coolant, which is circulated through hosing 44 by a water pump 46 into, and out of, a tank 48. Also illustrated is a hot swap 50 including two gas tanks 52 connected via a gas line 56, which allows one of the gas tanks to be exchanged without interrupting the flow of gaseous fuel (such as propane) to the generator during operation. The illustration includes a load 54, such as flood lights, which may be operated by the electricity generated by the remote field generator. FIG. 4 is the same as FIG. 3, except a mobile phone 60 including a lithium ion battery is electrically connected to the generator, for recharging the lithium ion battery, and a carbon monoxide detector 62 is present on the generator. FIG. 5 is the same as FIG. 3, except a ventilation fan 64 is electrically connected to the generator, and a cover 66 is present over the generator, protecting it from rain.

When the remote field generator is operated using unit measures of rubbing alcohol, optionally together with a pipe, a carbon monoxide detector, a water condenser which acts as a heat exchanger for heating water circulated by a water pump from a water tank, dramatic logistical advantages are obtained. In particular, no special fuel is needed to run the generator, and rather than water only rubbing alcohol need be transported. Hot water for bathing is produced as well as drinking water when optional components are included. Noise levels are reduced when optional components are included, by both the water condenser and the pipe, and any dangerous exhaust gasses are vented away from the generator. The optional carbon monoxide detector also provides an additional layer of safety against indoor accumulation of exhaust gasses. All together, recharging of batteries, and/or

the operation of small electronic device is provided for, in an efficient manner, with the transportation of a remote field generator; no significant logistical burden is created because rather than transport water, rubbing alcohol which is already available in unit measures may be transported to run the generator and will convert into a similar amount of potable water. Extra benefits also include the generation of heat or hot water for cooking, bathing or drinking.

What is claimed is:

1. A generator system, comprising:

- (i) an internal combustion engine,
- (ii) an exhaust gas outlet, connected to the internal combustion engine, for venting exhaust gasses,
- (iii) a condenser, connected to the exhaust gas outlet, for condensing water from the exhaust gasses, and
- (iv) a fuel selector, connected to the internal combustion engine, for adjusting the internal combustion engine to operate more efficiently on at least rubbing alcohol and propane gas,

wherein the internal combustion engine includes a manual choke.

2. The generator system of claim 1, further comprising:

- (v) a water tank,
- (vi) a water pump, and
- (vii) hosing, fluidly connecting the condenser, the water tank and the water pump.

3. The generator system of claim 1, further comprising:

- (viii) a flexible pipe, connected to the exhaust gas outlet, for directing the exhaust gasses,
- (ix) a carbon monoxide sensor, attached to the internal combustion engine, and
- (x) a catalytic converter, for reducing carbon monoxide present in the exhaust gasses, connected to the exhaust gas outlet,

wherein the pipe has a length of at least 5 feet.

4. The generator system of claim 2, further comprising:

- (viii) a flexible pipe, connected to the exhaust gas outlet, for directing the exhaust gasses,
- (ix) a carbon monoxide sensor, attached to the internal combustion engine, and
- (x) a catalytic converter, for reducing carbon monoxide present in the exhaust gasses, connected to the exhaust gas outlet,

wherein the pipe has a length of at least 5 feet.

5. The generator system of claim 1, further comprising:

- (xi) a ventilation fan, electrically connected to the internal combustion engine.

6. The generator system of claim 1, further comprising:

- (xii) a cover, covering the internal combustion engine.

7. The generator system of claim 1, further comprising:

- (xiii) a bottle adaptor, connected to the internal combustion engine, for holding and dispensing a bottle containing a unit measure of liquid fuel.

8. The generator system of claim 1, further comprising:

- (xiv) a hot swap, connected to the internal combustion engine, for removing and connecting a container of gaseous fuel without interrupting flow of a gaseous fuel.

9. The generator system of claim 1, further comprising:

- (xv) a timer, connected to the internal combustion engine, for selecting an amount of time for operation of the internal combustion engine.

10. A generator system, comprising:

- (1) an internal combustion engine,
- (2) an exhaust gas outlet, connected to the internal combustion engine, for venting exhaust gasses,
- (3) a heat exchanger, connected to the exhaust gas outlet, for exchanging heat from the exhaust gasses to water,

- (4) a water tank,
- (5) a water pump,
- (6) hosing, fluidly connecting the heat exchanger, the water tank and the water pump, and

- (7) a fuel selector, connected to the internal combustion engine, for adjusting the internal combustion engine to operate more efficiently on at least rubbing alcohol and propane gas,

wherein the internal combustion engine includes a manual choke.

11. The generator system of claim 10, further comprising:

- (8) a flexible pipe, connected to the exhaust gas outlet, for directing the exhaust gasses,
- (9) a carbon monoxide sensor, attached to the internal combustion engine, and
- (10) a catalytic converter, for reducing carbon monoxide present in the exhaust gasses, connected to the exhaust gas outlet,

wherein the pipe has a length of at least 5 feet.

12. The generator system of claim 11, wherein the pipe has a length of at least 20 feet.

13. The generator system of claim 10, further comprising:

- (11) a ventilation fan, electrically connected to the internal combustion engine.

14. A generator system, comprising:

- (a) an internal combustion engine,
- (b) an exhaust gas outlet, connected to the internal combustion engine, for venting exhaust gasses,
- (c) a flexible pipe, connected to the exhaust gas outlet, for directing the exhaust gasses,
- (d) a fuel selector, connected to the internal combustion engine, for adjusting the internal combustion engine to operate more efficiently on at least rubbing alcohol and propane gas,
- (e) optionally, a carbon monoxide sensor, attached to the internal combustion engine, and
- (f) optionally, a catalytic converter, for reducing carbon monoxide present in the exhaust gasses, connected to the exhaust gas outlet,

wherein the pipe has a length of at least 5 feet, and wherein the internal combustion engine includes a manual choke.

15. The generator system of claim 14, wherein the carbon monoxide sensor is configured to stop the internal combustion engine upon detection of carbon monoxide.

16. The generator system of claim 14, further comprising:

- (g) a ventilation fan, electrically connected to the internal combustion engine.

17. The generator system of claim 14, further comprising:

- (h) a timer, connected to the internal combustion engine, for selecting an amount of time for operation of the internal combustion engine.

18. The generator system of claim 7, wherein the bottle adaptor is adapted to receive a bottle having a volume of 1 pint, 1 quart, 500 milliliters, or 1000 milliliters.

19. The generator system of claim 10, further comprising:

- (12) a bottle adaptor, connected to the internal combustion engine, for holding and dispensing a bottle containing a unit measure of liquid fuel,
- wherein the bottle adaptor is adapted to receive a bottle having a volume of 1 pint, 1 quart, 500 milliliters, or 1000 milliliters.

20. The generator system of claim 14, further comprising:

- (i) a bottle adaptor, connected to the internal combustion engine, for holding and dispensing a bottle containing a unit measure of liquid fuel,

11

12

wherein the bottle adaptor is adapted to receive a bottle having a volume of 1 pint, 1 quart, 500 milliliters, or 1000 milliliters.

21. The generator system of claim **18**, wherein the bottle adaptor is a wide-mouth funnel. 5

22. The generator system of claim **21**, wherein the wide-mouth funnel has sides with a greater width than the width of the bottle and extending more than half the length of the bottle.

23. The generator system of claim **1**, wherein the internal combustion engine further comprises a carburetor. 10

* * * * *

UNITED STATES PATENT AND TRADEMARK OFFICE
CERTIFICATE OF CORRECTION

PATENT NO. : 9,175,601 B2
APPLICATION NO. : 13/343597
DATED : November 3, 2015
INVENTOR(S) : Larry J. Markoski

Page 1 of 1

It is certified that error appears in the above-identified patent and that said Letters Patent is hereby corrected as shown below:

On the Title Page

Item [56]

Column 2, Line 5, delete "Burr et al." and insert --Upton et al.--

Page 2, Column 2, Line 10, delete "2010-236301" and insert --10-236301--

Page 2, Column 2, Line 27, delete "12/2012" and insert --12/2010--

Page 2, Column 2, Line 40, delete "pdf.aspx?" and insert --pdf.aspx?--

Page 2, Column 2, Line 43, delete "pdf.aspx?" and insert --pdf.aspx?--

Signed and Sealed this
Fourteenth Day of November, 2017

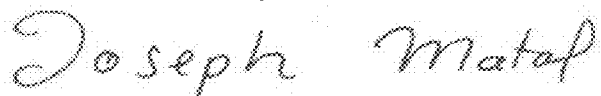

Joseph Matal

*Performing the Functions and Duties of the
Under Secretary of Commerce for Intellectual Property and
Director of the United States Patent and Trademark Office*