

# 3GPP TS 36.211 V8.7.0 (2009-05)

---

*Technical Specification*

## **3rd Generation Partnership Project; Technical Specification Group Radio Access Network; Evolved Universal Terrestrial Radio Access (E-UTRA); Physical Channels and Modulation (Release 8)**



The present document has been developed within the 3<sup>rd</sup> Generation Partnership Project (3GPP<sup>TM</sup>) and may be further elaborated for the purposes of 3GPP.

The present document has not been subject to any approval process by the 3GPP Organizational Partners and shall not be implemented. This Specification is provided for future development work within 3GPP only. The Organizational Partners accept no liability for any use of this Specification. Specifications and reports for implementation of the 3GPP<sup>TM</sup> system should be obtained via the 3GPP Organizational Partners' Publications Offices.

---

---

Keywords

UMTS, radio, layer 1

---

**3GPP**

---

Postal address

---

3GPP support office address

---

650 Route des Lucioles - Sophia Antipolis  
Valbonne - FRANCE  
Tel.: +33 4 92 94 42 00 Fax: +33 4 93 65 47 16

---

Internet

---

<http://www.3gpp.org>

---

**Copyright Notification**

---

No part may be reproduced except as authorized by written permission.  
The copyright and the foregoing restriction extend to reproduction in all media.

© 2009, 3GPP Organizational Partners (ARIB, ATIS, CCSA, ETSI, TTA, TTC).  
All rights reserved.

UMTS™ is a Trade Mark of ETSI registered for the benefit of its members  
3GPP™ is a Trade Mark of ETSI registered for the benefit of its Members and of the 3GPP Organizational Partners  
LTE™ is a Trade Mark of ETSI currently being registered for the benefit of its Members and of the 3GPP Organizational Partners  
GSM® and the GSM logo are registered and owned by the GSM Association

**3GPP**

# Contents

Foreword .....	6
1 Scope .....	7
2 References .....	7
3 Definitions, symbols and abbreviations .....	7
3.1 Symbols .....	7
3.2 Abbreviations .....	9
4 Frame structure .....	9
4.1 Frame structure type 1 .....	9
4.2 Frame structure type 2 .....	10
5 Uplink .....	11
5.1 Overview .....	11
5.1.1 Physical channels .....	11
5.1.2 Physical signals .....	11
5.2 Slot structure and physical resources .....	12
5.2.1 Resource grid .....	12
5.2.2 Resource elements .....	13
5.2.3 Resource blocks .....	13
5.3 Physical uplink shared channel .....	13
5.3.1 Scrambling .....	14
5.3.2 Modulation .....	14
5.3.3 Transform precoding .....	14
5.3.4 Mapping to physical resources .....	15
5.4 Physical uplink control channel .....	16
5.4.1 PUCCH formats 1, 1a and 1b .....	17
5.4.2 PUCCH formats 2, 2a and 2b .....	19
5.4.3 Mapping to physical resources .....	20
5.5 Reference signals .....	21
5.5.1 Generation of the reference signal sequence .....	21
5.5.1.1 Base sequences of length $3N_{sc}^{RB}$ or larger .....	22
5.5.1.2 Base sequences of length less than $3N_{sc}^{RB}$ .....	22
5.5.1.3 Group hopping .....	24
5.5.1.4 Sequence hopping .....	25
5.5.2 Demodulation reference signal .....	25
5.5.2.1 Demodulation reference signal for PUSCH .....	25
5.5.2.1.1 Reference signal sequence .....	25
5.5.2.1.2 Mapping to physical resources .....	26
5.5.2.2 Demodulation reference signal for PUCCH .....	27
5.5.2.2.1 Reference signal sequence .....	27
5.5.2.2.2 Mapping to physical resources .....	28
5.5.3 Sounding reference signal .....	28
5.5.3.1 Sequence generation .....	28
5.5.3.2 Mapping to physical resources .....	28
5.5.3.3 Sounding reference signal subframe configuration .....	31
5.6 SC-FDMA baseband signal generation .....	32
5.7 Physical random access channel .....	33
5.7.1 Time and frequency structure .....	33
5.7.2 Preamble sequence generation .....	39
5.7.3 Baseband signal generation .....	43
5.8 Modulation and upconversion .....	43
6 Downlink .....	44
6.1 Overview .....	44
6.1.1 Physical channels .....	44

6.1.2	Physical signals .....	44
6.2	Slot structure and physical resource elements .....	45
6.2.1	Resource grid .....	45
6.2.2	Resource elements.....	45
6.2.3	Resource blocks .....	46
6.2.3.1	Virtual resource blocks of localized type .....	47
6.2.3.2	Virtual resource blocks of distributed type.....	47
6.2.4	Resource-element groups .....	48
6.2.5	Guard period for half-duplex FDD operation.....	49
6.2.6	Guard Period for TDD Operation.....	49
6.3	General structure for downlink physical channels.....	49
6.3.1	Scrambling .....	50
6.3.2	Modulation .....	50
6.3.3	Layer mapping .....	50
6.3.3.1	Layer mapping for transmission on a single antenna port .....	50
6.3.3.2	Layer mapping for spatial multiplexing.....	51
6.3.3.3	Layer mapping for transmit diversity .....	51
6.3.4	Precoding .....	52
6.3.4.1	Precoding for transmission on a single antenna port .....	52
6.3.4.2	Precoding for spatial multiplexing.....	52
6.3.4.2.1	Precoding without CDD.....	52
6.3.4.2.2	Precoding for large delay CDD.....	52
6.3.4.2.3	Codebook for precoding .....	53
6.3.4.3	Precoding for transmit diversity .....	54
6.3.5	Mapping to resource elements.....	55
6.4	Physical downlink shared channel.....	55
6.5	Physical multicast channel.....	55
6.6	Physical broadcast channel.....	56
6.6.1	Scrambling .....	56
6.6.2	Modulation .....	56
6.6.3	Layer mapping and precoding.....	56
6.6.4	Mapping to resource elements.....	56
6.7	Physical control format indicator channel .....	57
6.7.1	Scrambling .....	57
6.7.2	Modulation .....	57
6.7.3	Layer mapping and precoding.....	58
6.7.4	Mapping to resource elements.....	58
6.8	Physical downlink control channel .....	58
6.8.1	PDCCH formats .....	58
6.8.2	PDCCH multiplexing and scrambling.....	59
6.8.3	Modulation .....	59
6.8.4	Layer mapping and precoding.....	59
6.8.5	Mapping to resource elements.....	59
6.9	Physical hybrid ARQ indicator channel.....	60
6.9.1	Modulation .....	61
6.9.2	Resource group alignment, layer mapping and precoding .....	62
6.9.3	Mapping to resource elements.....	63
6.10	Reference signals .....	65
6.10.1	Cell-specific reference signals .....	65
6.10.1.1	Sequence generation .....	65
6.10.1.2	Mapping to resource elements.....	66
6.10.2	MBSFN reference signals .....	68
6.10.2.1	Sequence generation .....	68
6.10.2.2	Mapping to resource elements.....	68
6.10.3	UE-specific reference signals.....	70
6.10.3.1	Sequence generation .....	70
6.10.3.2	Mapping to resource elements.....	71
6.11	Synchronization signals .....	72
6.11.1	Primary synchronization signal.....	73
6.11.1.1	Sequence generation.....	73
6.11.1.2	Mapping to resource elements.....	73
6.11.2	Secondary synchronization signal.....	73

6.11.2.1 Sequence generation ..... 73  
6.11.2.2 Mapping to resource elements ..... 75  
6.12 OFDM baseband signal generation ..... 76  
6.13 Modulation and upconversion ..... 76  
  
7 Generic functions ..... 77  
7.1 Modulation mapper ..... 77  
7.1.1 BPSK ..... 77  
7.1.2 QPSK ..... 77  
7.1.3 16QAM ..... 78  
7.1.4 64QAM ..... 78  
7.2 Pseudo-random sequence generation ..... 79  
  
8 Timing ..... 80  
8.1 Uplink-downlink frame timing ..... 80  
  
**Annex A (informative): Change history ..... 81**

---

## Foreword

This Technical Specification has been produced by the 3<sup>rd</sup> Generation Partnership Project (3GPP).

The contents of the present document are subject to continuing work within the TSG and may change following formal TSG approval. Should the TSG modify the contents of the present document, it will be re-released by the TSG with an identifying change of release date and an increase in version number as follows:

Version x.y.z

where:

- x the first digit:
  - 1 presented to TSG for information;
  - 2 presented to TSG for approval;
  - 3 or greater indicates TSG approved document under change control.
- y the second digit is incremented for all changes of substance, i.e. technical enhancements, corrections, updates, etc.
- z the third digit is incremented when editorial only changes have been incorporated in the document.

# 1 Scope

The present document describes the physical channels for evolved UTRA.

# 2 References

The following documents contain provisions which, through reference in this text, constitute provisions of the present document.

- References are either specific (identified by date of publication, edition number, version number, etc.) or non-specific.
- For a specific reference, subsequent revisions do not apply.
- For a non-specific reference, the latest version applies. In the case of a reference to a 3GPP document (including a GSM document), a non-specific reference implicitly refers to the latest version of that document *in the same Release as the present document*.

- [1] 3GPP TR 21.905: "Vocabulary for 3GPP Specifications".
- [2] 3GPP TS 36.201: "Evolved Universal Terrestrial Radio Access (E-UTRA); Physical Layer – General Description".
- [3] 3GPP TS 36.212: "Evolved Universal Terrestrial Radio Access (E-UTRA); Multiplexing and channel coding".
- [4] 3GPP TS 36.213: "Evolved Universal Terrestrial Radio Access (E-UTRA); Physical layer procedures".
- [5] 3GPP TS 36.214: "Evolved Universal Terrestrial Radio Access (E-UTRA); Physical layer – Measurements".
- [6] 3GPP TS 36.104: "Evolved Universal Terrestrial Radio Access (E-UTRA); Base Station (BS) radio transmission and reception".
- [7] 3GPP TS 36.101: "Evolved Universal Terrestrial Radio Access (E-UTRA); User Equipment (UE) radio transmission and reception".
- [8] 3GPP TS36.321, "Evolved Universal Terrestrial Radio Access (E-UTRA); Medium Access Control (MAC) protocol specification"

# 3 Definitions, symbols and abbreviations

## 3.1 Symbols

For the purposes of the present document, the following symbols apply:

$(k, l)$	Resource element with frequency-domain index $k$ and time-domain index $l$
$a_{k,l}^{(p)}$	Value of resource element $(k, l)$ [for antenna port $p$ ]
$D$	Matrix for supporting cyclic delay diversity
$D_{RA}$	Density of random access opportunities per radio frame
$f_0$	Carrier frequency

$f_{RA}$	PRACH resource frequency index within the considered time domain location
$M_{sc}^{PUSCH}$	Scheduled bandwidth for uplink transmission, expressed as a number of subcarriers
$M_{RB}^{PUSCH}$	Scheduled bandwidth for uplink transmission, expressed as a number of resource blocks
$M_{bit}^{(q)}$	Number of coded bits to transmit on a physical channel [for code word $q$ ]
$M_{symb}^{(q)}$	Number of modulation symbols to transmit on a physical channel [for code word $q$ ]
$M_{symb}^{layer}$	Number of modulation symbols to transmit per layer for a physical channel
$M_{symb}^{ap}$	Number of modulation symbols to transmit per antenna port for a physical channel
$N$	A constant equal to 2048 for $\Delta f = 15$ kHz and 4096 for $\Delta f = 7.5$ kHz
$N_{CP,l}$	Downlink cyclic prefix length for OFDM symbol $l$ in a slot
$N_{cs}^{(1)}$	Number of cyclic shifts used for PUCCH formats 1/1a/1b in a resource block with a mix of formats 1/1a/1b and 2/2a/2b
$N_{RB}^{(2)}$	Bandwidth available for use by PUCCH formats 2/2a/2b, expressed in multiples of $N_{sc}^{RB}$
$N_{RB}^{HO}$	The offset used for PUSCH frequency hopping, expressed in number of resource blocks (set by higher layers)
$N_{ID}^{cell}$	Physical layer cell identity
$N_{ID}^{MBSFN}$	MBSFN area identity
$N_{RB}^{DL}$	Downlink bandwidth configuration, expressed in multiples of $N_{sc}^{RB}$
$N_{RB}^{min,DL}$	Smallest downlink bandwidth configuration, expressed in multiples of $N_{sc}^{RB}$
$N_{RB}^{max,DL}$	Largest downlink bandwidth configuration, expressed in multiples of $N_{sc}^{RB}$
$N_{RB}^{UL}$	Uplink bandwidth configuration, expressed in multiples of $N_{sc}^{RB}$
$N_{RB}^{min,UL}$	Smallest uplink bandwidth configuration, expressed in multiples of $N_{sc}^{RB}$
$N_{RB}^{max,UL}$	Largest uplink bandwidth configuration, expressed in multiples of $N_{sc}^{RB}$
$N_{symb}^{DL}$	Number of OFDM symbols in a downlink slot
$N_{symb}^{UL}$	Number of SC-FDMA symbols in an uplink slot
$N_{sc}^{RB}$	Resource block size in the frequency domain, expressed as a number of subcarriers
$N_{SP}$	Number of downlink to uplink switch points within the radio frame
$N_{RS}^{PUCCH}$	Number of reference symbols per slot for PUCCH
$N_{TA}$	Timing offset between uplink and downlink radio frames at the UE, expressed in units of $T_s$
$N_{TA\ offset}$	Fixed timing advance offset, expressed in units of $T_s$
$n_{PUCCH}^{(1)}$	Resource index for PUCCH formats 1/1a/1b
$n_{PUCCH}^{(2)}$	Resource index for PUCCH formats 2/2a/2b
$n_{PDCCH}$	Number of PDCCHs present in a subframe
$n_{PRB}$	Physical resource block number
$n_{PRB}^{RA}$	First physical resource block occupied by PRACH resource considered
$n_{PRB\ offset}^{RA}$	First physical resource block available for PRACH
$n_{VRB}$	Virtual resource block number
$n_{RNTI}$	Radio network temporary identifier
$n_f$	System frame number
$n_s$	Slot number within a radio frame
$P$	Number of cell-specific antenna ports
$p$	Antenna port number
$q$	Code word number
$r_{RA}$	Index for PRACH versions with same preamble format and PRACH density

$Q_m$	Modulation order: 2 for QPSK, 4 for 16QAM and 6 for 64QAM transmissions
$s_l^{(p)}(t)$	Time-continuous baseband signal for antenna port $p$ and OFDM symbol $l$ in a slot
$t_{RA}^0$	Radio frame indicator index of PRACH opportunity
$t_{RA}^1$	Half frame index of PRACH opportunity within the radio frame
$t_{RA}^2$	Uplink subframe number for start of PRACH opportunity within the half frame
$T_f$	Radio frame duration
$T_s$	Basic time unit
$T_{slot}$	Slot duration
$W$	Precoding matrix for downlink spatial multiplexing
$\beta_{PRACH}$	Amplitude scaling for PRACH
$\beta_{PUCCH}$	Amplitude scaling for PUCCH
$\beta_{PUSCH}$	Amplitude scaling for PUSCH
$\beta_{SRS}$	Amplitude scaling for sounding reference symbols
$\Delta f$	Subcarrier spacing
$\Delta f_{RA}$	Subcarrier spacing for the random access preamble
$v$	Number of transmission layers

## 3.2 Abbreviations

For the purposes of the present document, the following abbreviations apply:

CCE	Control Channel Element
CDD	Cyclic Delay Diversity
PBCH	Physical broadcast channel
PCFICH	Physical control format indicator channel
PDCCH	Physical downlink control channel
PDSCH	Physical downlink shared channel
PHICH	Physical hybrid-ARQ indicator channel
PMCH	Physical multicast channel
PRACH	Physical random access channel
PUCCH	Physical uplink control channel
PUSCH	Physical uplink shared channel

---

## 4 Frame structure

Throughout this specification, unless otherwise noted, the size of various fields in the time domain is expressed as a number of time units  $T_s = 1/(15000 \times 2048)$  seconds.

Downlink and uplink transmissions are organized into radio frames with  $T_f = 307200 \times T_s = 10$  ms duration. Two radio frame structures are supported:

- Type 1, applicable to FDD,
- Type 2, applicable to TDD.

### 4.1 Frame structure type 1

Frame structure type 1 is applicable to both full duplex and half duplex FDD. Each radio frame is  $T_f = 307200 \cdot T_s = 10$  ms long and consists of 20 slots of length  $T_{slot} = 15360 \cdot T_s = 0.5$  ms, numbered from 0 to 19. A subframe is defined as two consecutive slots where subframe  $i$  consists of slots  $2i$  and  $2i + 1$ .

For FDD, 10 subframes are available for downlink transmission and 10 subframes are available for uplink transmissions in each 10 ms interval. Uplink and downlink transmissions are separated in the frequency domain. In half-duplex FDD operation, the UE cannot transmit and receive at the same time while there are no such restrictions in full-duplex FDD.

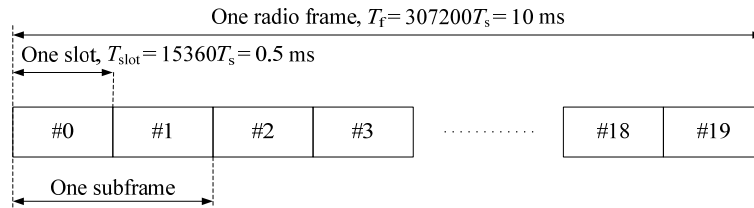

Figure 4.1-1: Frame structure type 1.

## 4.2 Frame structure type 2

Frame structure type 2 is applicable to TDD. Each radio frame of length  $T_f = 307200 \cdot T_s = 10$  ms consists of two half-frames of length  $153600 \cdot T_s = 5$  ms each. Each half-frame consists of five subframes of length  $30720 \cdot T_s = 1$  ms. The supported uplink-downlink configurations are listed in Table 4.2-2 where, for each subframe in a radio frame, “D” denotes the subframe is reserved for downlink transmissions, “U” denotes the subframe is reserved for uplink transmissions and “S” denotes a special subframe with the three fields DwPTS, GP and UpPTS. The length of DwPTS and UpPTS is given by Table 4.2-1 subject to the total length of DwPTS, GP and UpPTS being equal to  $30720 \cdot T_s = 1$  ms. Each subframe  $i$  is defined as two slots,  $2i$  and  $2i + 1$  of length  $T_{slot} = 15360 \cdot T_s = 0.5$  ms in each subframe.

Uplink-downlink configurations with both 5 ms and 10 ms downlink-to-uplink switch-point periodicity are supported.

In case of 5 ms downlink-to-uplink switch-point periodicity, the special subframe exists in both half-frames.

In case of 10 ms downlink-to-uplink switch-point periodicity, the special subframe exists in the first half-frame only.

Subframes 0 and 5 and DwPTS are always reserved for downlink transmission. UpPTS and the subframe immediately following the special subframe are always reserved for uplink transmission.

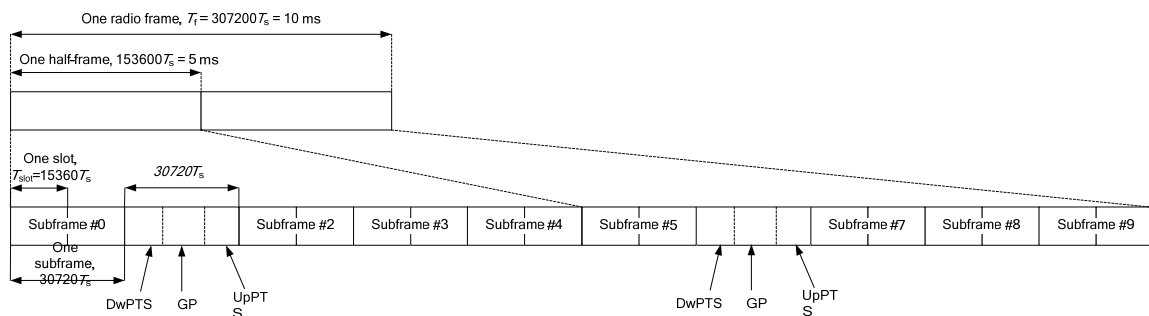

Figure 4.2-1: Frame structure type 2 (for 5 ms switch-point periodicity).

Table 4.2-1: Configuration of special subframe (lengths of DwPTS/GP/UpPTS).

Special subframe configuration	Normal cyclic prefix in downlink		Extended cyclic prefix in downlink		
	DwPTS	UpPTS	DwPTS	Normal cyclic prefix in uplink	Extended cyclic prefix in uplink
0	$6592 \cdot T_s$	$2192 \cdot T_s$	$2560 \cdot T_s$	$7680 \cdot T_s$	$2560 \cdot T_s$
1	$19760 \cdot T_s$			$20480 \cdot T_s$	
2	$21952 \cdot T_s$			$23040 \cdot T_s$	
3	$24144 \cdot T_s$			$25600 \cdot T_s$	
4	$26336 \cdot T_s$	$4384 \cdot T_s$	$5120 \cdot T_s$	$7680 \cdot T_s$	$5120 \cdot T_s$
5	$6592 \cdot T_s$			$20480 \cdot T_s$	
6	$19760 \cdot T_s$			$23040 \cdot T_s$	
7	$21952 \cdot T_s$			-	
8	$24144 \cdot T_s$			-	-

Table 4.2-2: Uplink-downlink configurations.

Uplink-downlink configuration	Downlink-to-Uplink Switch-point periodicity	Subframe number									
		0	1	2	3	4	5	6	7	8	9
0	5 ms	D	S	U	U	U	D	S	U	U	U
1	5 ms	D	S	U	U	D	D	S	U	U	D
2	5 ms	D	S	U	D	D	D	S	U	D	D
3	10 ms	D	S	U	U	U	D	D	D	D	D
4	10 ms	D	S	U	U	D	D	D	D	D	D
5	10 ms	D	S	U	D	D	D	D	D	D	D
6	5 ms	D	S	U	U	U	D	S	U	U	D

## 5 Uplink

### 5.1 Overview

The smallest resource unit for uplink transmissions is denoted a resource element and is defined in section 5.2.2.

#### 5.1.1 Physical channels

An uplink physical channel corresponds to a set of resource elements carrying information originating from higher layers and is the interface defined between 36.212 and 36.211. The following uplink physical channels are defined:

- Physical Uplink Shared Channel, PUSCH
- Physical Uplink Control Channel, PUCCH
- Physical Random Access Channel, PRACH

#### 5.1.2 Physical signals

An uplink physical signal is used by the physical layer but does not carry information originating from higher layers. The following uplink physical signals are defined:

- Reference signal

## 5.2 Slot structure and physical resources

### 5.2.1 Resource grid

The transmitted signal in each slot is described by a resource grid of  $N_{RB}^{UL} N_{sc}^{RB}$  subcarriers and  $N_{symb}^{UL}$  SC-FDMA symbols. The resource grid is illustrated in Figure 5.2.1-1. The quantity  $N_{RB}^{UL}$  depends on the uplink transmission bandwidth configured in the cell and shall fulfil

$$N_{RB}^{min,UL} \leq N_{RB}^{UL} \leq N_{RB}^{max,UL}$$

where  $N_{RB}^{min,UL} = 6$  and  $N_{RB}^{max,UL} = 110$  is the smallest and largest uplink bandwidth, respectively, supported by the current version of this specification. The set of allowed values for  $N_{RB}^{UL}$  is given by [7].

The number of SC-FDMA symbols in a slot depends on the cyclic prefix length configured by higher layers and is given in Table 5.2.3-1.

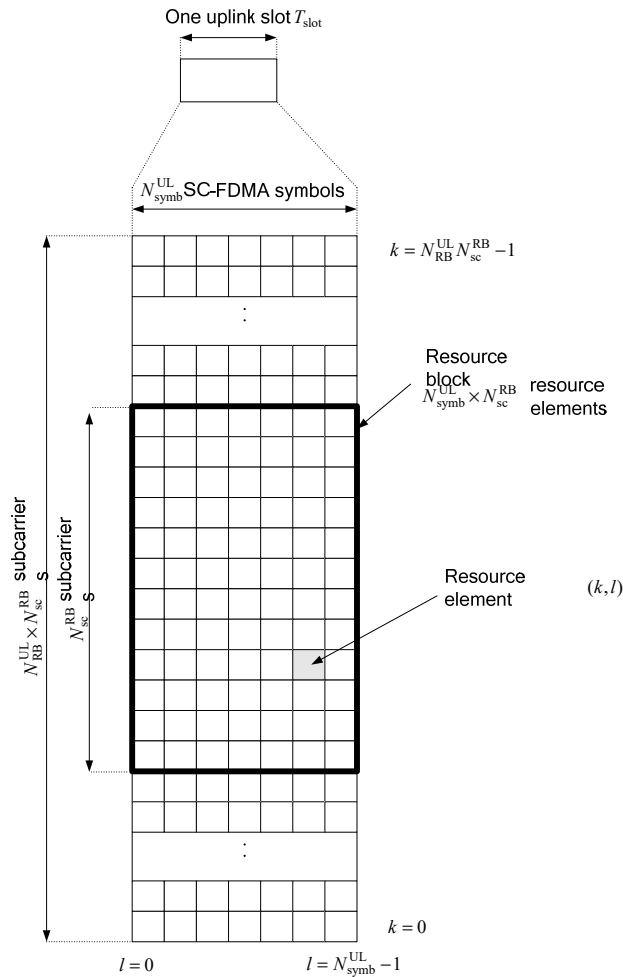

Figure 5.2.1-1: Uplink resource grid.

## 5.2.2 Resource elements

Each element in the resource grid is called a resource element and is uniquely defined by the index pair  $(k, l)$  in a slot where  $k = 0, \dots, N_{\text{RB}}^{\text{UL}} N_{\text{sc}}^{\text{RB}} - 1$  and  $l = 0, \dots, N_{\text{symb}}^{\text{UL}} - 1$  are the indices in the frequency and time domain, respectively.

Resource element  $(k, l)$  corresponds to the complex value  $a_{k,l}$ . Quantities  $a_{k,l}$  corresponding to resource elements not used for transmission of a physical channel or a physical signal in a slot shall be set to zero.

## 5.2.3 Resource blocks

A physical resource block is defined as  $N_{\text{symb}}^{\text{UL}}$  consecutive SC-FDMA symbols in the time domain and  $N_{\text{sc}}^{\text{RB}}$  consecutive subcarriers in the frequency domain, where  $N_{\text{symb}}^{\text{UL}}$  and  $N_{\text{sc}}^{\text{RB}}$  are given by Table 5.2.3-1. A physical resource block in the uplink thus consists of  $N_{\text{symb}}^{\text{UL}} \times N_{\text{sc}}^{\text{RB}}$  resource elements, corresponding to one slot in the time domain and 180 kHz in the frequency domain.

**Table 5.2.3-1: Resource block parameters.**

Configuration	$N_{\text{sc}}^{\text{RB}}$	$N_{\text{symb}}^{\text{UL}}$
Normal cyclic prefix	12	7
Extended cyclic prefix	12	6

The relation between the physical resource block number  $n_{\text{PRB}}$  in the frequency domain and resource elements  $(k, l)$  in a slot is given by

$$n_{\text{PRB}} = \left\lfloor \frac{k}{N_{\text{sc}}^{\text{RB}}} \right\rfloor$$

## 5.3 Physical uplink shared channel

The baseband signal representing the physical uplink shared channel is defined in terms of the following steps:

- scrambling
- modulation of scrambled bits to generate complex-valued symbols
- transform precoding to generate complex-valued symbols
- mapping of complex-valued symbols to resource elements
- generation of complex-valued time-domain SC-FDMA signal for each antenna port

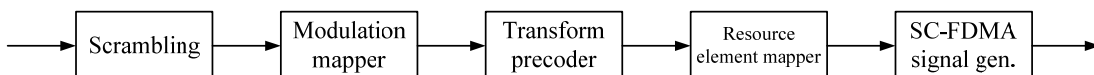

**Figure 5.3-1: Overview of uplink physical channel processing.**

### 5.3.1 Scrambling

The block of bits  $b(0), \dots, b(M_{\text{bit}} - 1)$ , where  $M_{\text{bit}}$  is the number of bits transmitted on the physical uplink shared channel in one subframe, shall be scrambled with a UE-specific scrambling sequence prior to modulation, resulting in a block of scrambled bits  $\tilde{b}(0), \dots, \tilde{b}(M_{\text{bit}} - 1)$  according to the following pseudo code

```

Set  $i = 0$ 
while  $i < M_{\text{bit}}$ 
  if  $b(i) = x$  // ACK/NAK or Rank Indication placeholder bits
     $\tilde{b}(i) = 1$ 
  else
    if  $b(i) = y$  // ACK/NAK or Rank Indication repetition placeholder bits
       $\tilde{b}(i) = \tilde{b}(i-1)$ 
    Else // Data or channel quality coded bits, Rank Indication coded bits or ACK/NAK coded bits
       $\tilde{b}(i) = (b(i) + c(i)) \bmod 2$ 
    end if
  end if
   $i = i + 1$ 
end while

```

where  $x$  and  $y$  are tags defined in [3] section 5.2.2.6 and where the scrambling sequence  $c(i)$  is given by Section 7.2. The scrambling sequence generator shall be initialised with  $c_{\text{init}} = n_{\text{RNTI}} \cdot 2^{14} + \lfloor n_s / 2 \rfloor \cdot 2^9 + N_{\text{ID}}^{\text{cell}}$  at the start of each subframe where  $n_{\text{RNTI}}$  corresponds to the RNTI associated with the PUSCH transmission as described in Section 8[4].

### 5.3.2 Modulation

The block of scrambled bits  $\tilde{b}(0), \dots, \tilde{b}(M_{\text{bit}} - 1)$  shall be modulated as described in Section 7.1, resulting in a block of complex-valued symbols  $d(0), \dots, d(M_{\text{symb}} - 1)$ . Table 5.3.2-1 specifies the modulation mappings applicable for the physical uplink shared channel.

**Table 5.3.2-1: Uplink modulation schemes**

Physical channel	Modulation schemes
PUSCH	QPSK, 16QAM, 64QAM

### 5.3.3 Transform precoding

The block of complex-valued symbols  $d(0), \dots, d(M_{\text{symb}} - 1)$  is divided into  $M_{\text{symb}} / M_{\text{sc}}^{\text{PUSCH}}$  sets, each corresponding to one SC-FDMA symbol. Transform precoding shall be applied according to

$$z(l \cdot M_{sc}^{\text{PUSCH}} + k) = \frac{1}{\sqrt{M_{sc}^{\text{PUSCH}}}} \sum_{i=0}^{M_{sc}^{\text{PUSCH}} - 1} d(l \cdot M_{sc}^{\text{PUSCH}} + i) e^{-j \frac{2\pi k i}{M_{sc}^{\text{PUSCH}}}}$$

$$k = 0, \dots, M_{sc}^{\text{PUSCH}} - 1$$

$$l = 0, \dots, M_{\text{symb}} / M_{sc}^{\text{PUSCH}} - 1$$

resulting in a block of complex-valued symbols  $z(0), \dots, z(M_{\text{symb}} - 1)$ . The variable  $M_{sc}^{\text{PUSCH}} = M_{\text{RB}}^{\text{PUSCH}} \cdot N_{sc}^{\text{RB}}$ , where  $M_{\text{RB}}^{\text{PUSCH}}$  represents the bandwidth of the PUSCH in terms of resource blocks, and shall fulfil

$$M_{\text{RB}}^{\text{PUSCH}} = 2^{\alpha_2} \cdot 3^{\alpha_3} \cdot 5^{\alpha_5} \leq N_{\text{RB}}^{\text{UL}}$$

where  $\alpha_2, \alpha_3, \alpha_5$  is a set of non-negative integers.

### 5.3.4 Mapping to physical resources

The block of complex-valued symbols  $z(0), \dots, z(M_{\text{symb}} - 1)$  shall be multiplied with the amplitude scaling factor  $\beta_{\text{PUSCH}}$  in order to conform to the transmit power  $P_{\text{PUSCH}}$  specified in Section 5.1.1.1 in [4], and mapped in sequence starting with  $z(0)$  to physical resource blocks assigned for transmission of PUSCH. The mapping to resource elements  $(k, l)$  corresponding to the physical resource blocks assigned for transmission and not used for transmission of reference signals and not reserved for possible SRS transmission shall be in increasing order of first the index  $k$ , then the index  $l$ , starting with the first slot in the subframe.

If uplink frequency-hopping is disabled, the set of physical resource blocks to be used for transmission are given by  $n_{\text{PRB}} = n_{\text{VRB}}$  where  $n_{\text{VRB}}$  is obtained from the uplink scheduling grant as described in Section 8.1 in [4].

If uplink frequency-hopping with type 1 PUSCH hopping is enabled, the set of physical resource blocks to be used for transmission are given by Section 8.4.1 in [4].

If uplink frequency-hopping with predefined hopping pattern is enabled, the set of physical resource blocks to be used for transmission in slot  $n_s$  is given by the scheduling grant together with a predefined pattern according to

$$\tilde{n}_{\text{PRB}}(n_s) = (\tilde{n}_{\text{VRB}} + f_{\text{hop}}(i) \cdot N_{\text{RB}}^{\text{sb}} + ((N_{\text{RB}}^{\text{sb}} - 1) - 2(\tilde{n}_{\text{VRB}} \bmod N_{\text{RB}}^{\text{sb}})) \cdot f_m(i)) \bmod (N_{\text{RB}}^{\text{sb}} \cdot N_{\text{sb}})$$

$$i = \begin{cases} \lfloor n_s / 2 \rfloor & \text{inter-subframe hopping} \\ n_s & \text{intra and inter-subframe hopping} \end{cases}$$

$$n_{\text{PRB}}(n_s) = \begin{cases} \tilde{n}_{\text{PRB}}(n_s) & N_{\text{sb}} = 1 \\ \tilde{n}_{\text{PRB}}(n_s) + \lfloor N_{\text{RB}}^{\text{HO}} / 2 \rfloor & N_{\text{sb}} > 1 \end{cases}$$

$$\tilde{n}_{\text{VRB}} = \begin{cases} n_{\text{VRB}} & N_{\text{sb}} = 1 \\ n_{\text{VRB}} - \lfloor N_{\text{RB}}^{\text{HO}} / 2 \rfloor & N_{\text{sb}} > 1 \end{cases}$$

where  $n_{\text{VRB}}$  is obtained from the scheduling grant as described in Section 8.1 in [4]. The parameter *pusch-HoppingOffset*,  $N_{\text{RB}}^{\text{HO}}$ , is provided by higher layers.. The size  $N_{\text{RB}}^{\text{sb}}$  of each sub-band is given by,

$$N_{\text{RB}}^{\text{sb}} = \begin{cases} N_{\text{RB}}^{\text{UL}} & N_{\text{sb}} = 1 \\ \lfloor (N_{\text{RB}}^{\text{UL}} - N_{\text{RB}}^{\text{HO}} - N_{\text{RB}}^{\text{HO}} \bmod 2) / N_{\text{sb}} \rfloor & N_{\text{sb}} > 1 \end{cases}$$

where the number of sub-bands  $N_{\text{sb}}$  is given by higher layers. The function  $f_m(i) \in \{0, 1\}$  determines whether mirroring is used or not. The parameter *Hopping-mode* provided by higher layers determines if hopping is “inter-subframe” or “intra and inter-subframe”.

The hopping function  $f_{\text{hop}}(i)$  and the function  $f_m(i)$  are given by

$$f_{\text{hop}}(i) = \begin{cases} 0 & N_{sb} = 1 \\ (f_{\text{hop}}(i-1) + \sum_{k=i+10}^{i+19} c(k) \times 2^{k-(i+10)}) \bmod N_{sb} & N_{sb} = 2 \\ (f_{\text{hop}}(i-1) + \left( \sum_{k=i+10}^{i+19} c(k) \times 2^{k-(i+10)} \right) \bmod (N_{sb} - 1) + 1) \bmod N_{sb} & N_{sb} > 2 \end{cases}$$

$$f_m(i) = \begin{cases} i \bmod 2 & N_{sb} = 1 \text{ and intra and inter - subframe hopping} \\ \text{CURRENT\_TX\_NB} \bmod 2 & N_{sb} = 1 \text{ and inter - subframe hopping} \\ c(i \cdot 10) & N_{sb} > 1 \end{cases}$$

where  $f_{\text{hop}}(-1) = 0$  and the pseudo-random sequence  $c(i)$  is given by section 7.2 and CURRENT\_TX\_NB indicates the transmission number for the transport block transmitted in slot  $n_s$  as defined in [8]. The pseudo-random sequence generator shall be initialised with  $c_{\text{init}} = N_{\text{ID}}^{\text{cell}}$  for FDD and  $c_{\text{init}} = 2^9 \cdot (n_f \bmod 4) + N_{\text{ID}}^{\text{cell}}$  for TDD at the start of each frame.

## 5.4 Physical uplink control channel

The physical uplink control channel, PUCCH, carries uplink control information. The PUCCH is never transmitted simultaneously with the PUSCH from the same UE. For frame structure type 2, the PUCCH is not transmitted in the UpPTS field.

The physical uplink control channel supports multiple formats as shown in Table 5.4-1. Formats 2a and 2b are supported for normal cyclic prefix only.

**Table 5.4-1: Supported PUCCH formats.**

PUCCH format	Modulation scheme	Number of bits per subframe, $M_{\text{bit}}$
1	N/A	N/A
1a	BPSK	1
1b	QPSK	2
2	QPSK	20
2a	QPSK+BPSK	21
2b	QPSK+QPSK	22

All PUCCH formats use a cyclic shift of a sequence in each symbol, where  $n_{\text{cs}}^{\text{cell}}(n_s, l)$  is used to derive the cyclic shift for the different PUCCH formats. The quantity  $n_{\text{cs}}^{\text{cell}}(n_s, l)$  varies with the symbol number  $l$  and the slot number  $n_s$  according to

$$n_{\text{cs}}^{\text{cell}}(n_s, l) = \sum_{i=0}^7 c(8N_{\text{symb}}^{\text{UL}} \cdot n_s + 8l + i) \cdot 2^i$$

where the pseudo-random sequence  $c(i)$  is defined by section 7.2. The pseudo-random sequence generator shall be initialized with  $c_{\text{init}} = N_{\text{ID}}^{\text{cell}}$  at the beginning of each radio frame.

The physical resources used for PUCCH depends on two parameters,  $N_{\text{RB}}^{(2)}$  and  $N_{\text{cs}}^{(1)}$ , given by higher layers. The variable  $N_{\text{RB}}^{(2)} \geq 0$  denotes the bandwidth in terms of resource blocks that are available for use by PUCCH formats 2/2a/2b transmission in each slot. The variable  $N_{\text{cs}}^{(1)}$  denotes the number of cyclic shift used for PUCCH formats 1/1a/1b in a resource block used for a mix of formats 1/1a/1b and 2/2a/2b. The value of  $N_{\text{cs}}^{(1)}$  is an integer multiple of  $\Delta_{\text{shift}}^{\text{PUCCH}}$  within the range of  $\{0, 1, \dots, 7\}$ , where  $\Delta_{\text{shift}}^{\text{PUCCH}}$  is provided by higher layers. No mixed resource block is

present if  $N_{cs}^{(1)} = 0$ . At most one resource block in each slot supports a mix of formats 1/1a/1b and 2/2a/2b. Resources used for transmission of PUCCH format 1/1a/1b and 2/2a/2b are represented by the non-negative indices  $n_{PUCCH}^{(1)}$  and  $n_{PUCCH}^{(2)} < N_{RB}^{(2)} N_{sc}^{RB} + \left\lceil \frac{N_{cs}^{(1)}}{8} \right\rceil \cdot (N_{sc}^{RB} - N_{cs}^{(1)} - 2)$ , respectively.

### 5.4.1 PUCCH formats 1, 1a and 1b

For PUCCH format 1, information is carried by the presence/absence of transmission of PUCCH from the UE. In the remainder of this section,  $d(0) = 1$  shall be assumed for PUCCH format 1.

For PUCCH formats 1a and 1b, one or two explicit bits are transmitted, respectively. The block of bits  $b(0), \dots, b(M_{bit} - 1)$  shall be modulated as described in Table 5.4.1-1, resulting in a complex-valued symbol  $d(0)$ . The modulation schemes for the different PUCCH formats are given by Table 5.4-1.

The complex-valued symbol  $d(0)$  shall be multiplied with a cyclically shifted length  $N_{seq}^{PUCCH} = 12$  sequence  $r_{u,v}^{(\alpha)}(n)$  according to

$$y(n) = d(0) \cdot r_{u,v}^{(\alpha)}(n), \quad n = 0, 1, \dots, N_{seq}^{PUCCH} - 1$$

where  $r_{u,v}^{(\alpha)}(n)$  is defined by section 5.5.1 with  $M_{sc}^{RS} = N_{seq}^{PUCCH}$ . The cyclic shift  $\alpha$  varies between symbols and slots as defined below.

The block of complex-valued symbols  $y(0), \dots, y(N_{seq}^{PUCCH} - 1)$  shall be scrambled by  $S(n_s)$  and block-wise spread with the orthogonal sequence  $w_{n_{oc}}(i)$  according to

$$z(m' \cdot N_{SF}^{PUCCH} + m \cdot N_{seq}^{PUCCH} + n) = S(n_s) \cdot w_{n_{oc}}(m) \cdot y(n)$$

where

$$\begin{aligned} m &= 0, \dots, N_{SF}^{PUCCH} - 1 \\ n &= 0, \dots, N_{seq}^{PUCCH} - 1 \\ m' &= 0, 1 \end{aligned}$$

and

$$S(n_s) = \begin{cases} 1 & \text{if } n'(n_s) \bmod 2 = 0 \\ e^{j\pi/2} & \text{otherwise} \end{cases}$$

with  $N_{SF}^{PUCCH} = 4$  for both slots of normal PUCCH formats 1/1a/1b, and  $N_{SF}^{PUCCH} = 4$  for the first slot and  $N_{SF}^{PUCCH} = 3$  for the second slot of shortened PUCCH formats 1/1a/1b. The sequence  $w_{n_{oc}}(i)$  is given by Table 5.4.1-2 and Table 5.4.1-3 and  $n'(n_s)$  is defined below.

Resources used for transmission of PUCCH format 1, 1a and 1b are identified by a resource index  $n_{PUCCH}^{(1)}$  from which the orthogonal sequence index  $n_{oc}(n_s)$  and the cyclic shift  $\alpha(n_s, l)$  are determined according to

$$n_{oc}(n_s) = \begin{cases} \lfloor n'(n_s) \cdot \Delta_{\text{shift}}^{\text{PUCCH}} / N' \rfloor & \text{for normal cyclic prefix} \\ 2 \cdot \lfloor n'(n_s) \cdot \Delta_{\text{shift}}^{\text{PUCCH}} / N' \rfloor & \text{for extended cyclic prefix} \end{cases}$$

$$\alpha(n_s, l) = 2\pi \cdot n_{cs}(n_s, l) / N_{sc}^{\text{RB}}$$

$$n_{cs}(n_s, l) = \begin{cases} \left[ \left[ n_{cs}^{\text{cell}}(n_s, l) + \left( n'(n_s) \cdot \Delta_{\text{shift}}^{\text{PUCCH}} + (n_{oc}(n_s) \bmod \Delta_{\text{shift}}^{\text{PUCCH}}) \right) \bmod N' \right] \bmod N_{sc}^{\text{RB}} \right] & \text{for normal cyclic prefix} \\ \left[ \left[ n_{cs}^{\text{cell}}(n_s, l) + \left( n'(n_s) \cdot \Delta_{\text{shift}}^{\text{PUCCH}} + n_{oc}(n_s) / 2 \right) \bmod N' \right] \bmod N_{sc}^{\text{RB}} \right] & \text{for extended cyclic prefix} \end{cases}$$

where

$$N' = \begin{cases} N_{cs}^{(1)} & \text{if } n_{\text{PUCCH}}^{(1)} < c \cdot N_{cs}^{(1)} / \Delta_{\text{shift}}^{\text{PUCCH}} \\ N_{sc}^{\text{RB}} & \text{otherwise} \end{cases}$$

$$c = \begin{cases} 3 & \text{normal cyclic prefix} \\ 2 & \text{extended cyclic prefix} \end{cases}$$

The resource indices within the two resource blocks in the two slots of a subframe to which the PUCCH is mapped are given by

$$n'(n_s) = \begin{cases} n_{\text{PUCCH}}^{(1)} & \text{if } n_{\text{PUCCH}}^{(1)} < c \cdot N_{cs}^{(1)} / \Delta_{\text{shift}}^{\text{PUCCH}} \\ \left( n_{\text{PUCCH}}^{(1)} - c \cdot N_{cs}^{(1)} / \Delta_{\text{shift}}^{\text{PUCCH}} \right) \bmod \left( c \cdot N_{sc}^{\text{RB}} / \Delta_{\text{shift}}^{\text{PUCCH}} \right) & \text{otherwise} \end{cases}$$

for  $n_s \bmod 2 = 0$  and by

$$n'(n_s) = \begin{cases} \left[ \left[ c(n'(n_s - 1) + 1) \right] \bmod \left( cN_{sc}^{\text{RB}} / \Delta_{\text{shift}}^{\text{PUCCH}} + 1 \right) - 1 \right] & n_{\text{PUCCH}}^{(1)} \geq c \cdot N_{cs}^{(1)} / \Delta_{\text{shift}}^{\text{PUCCH}} \\ \left[ \left[ h / c \right] + (h \bmod c) N' / \Delta_{\text{shift}}^{\text{PUCCH}} \right] & \text{otherwise} \end{cases}$$

for  $n_s \bmod 2 = 1$ , where  $h = (n'(n_s - 1) + d) \bmod (cN' / \Delta_{\text{shift}}^{\text{PUCCH}})$ , with  $d = 2$  for normal CP and  $d = 0$  for extended CP.

The parameter *deltaPUCCH-Shift*  $\Delta_{\text{shift}}^{\text{PUCCH}}$  is provided by higher layers.

**Table 5.4.1-1: Modulation symbol  $d(0)$  for PUCCH formats 1a and 1b.**

PUCCH format	$b(0), \dots, b(M_{\text{bit}} - 1)$	$d(0)$
1a	0	1
	1	-1
1b	00	1
	01	-j
	10	j
	11	-1

**Table 5.4.1-2: Orthogonal sequences**  $[w(0) \dots w(N_{SF}^{PUCCH} - 1)]$  **for**  $N_{SF}^{PUCCH} = 4$ .

Sequence index $n_{oc}(n_s)$	Orthogonal sequences $[w(0) \dots w(N_{SF}^{PUCCH} - 1)]$
0	<b>Error! Objects cannot be created from editing field codes.</b>
1	<b>Error! Objects cannot be created from editing field codes.</b>
2	<b>Error! Objects cannot be created from editing field codes.</b>

**Table 5.4.1-3: Orthogonal sequences**  $[w(0) \dots w(N_{SF}^{PUCCH} - 1)]$  **for**  $N_{SF}^{PUCCH} = 3$ .

Sequence index $n_{oc}(n_s)$	Orthogonal sequences $[w(0) \dots w(N_{SF}^{PUCCH} - 1)]$
<b>0</b>	$[1 \ 1 \ 1]$
<b>1</b>	$[1 \ e^{j2\pi/3} \ e^{j4\pi/3}]$
<b>2</b>	$[1 \ e^{j4\pi/3} \ e^{j2\pi/3}]$

## 5.4.2 PUCCH formats 2, 2a and 2b

The block of bits  $b(0), \dots, b(19)$  shall be scrambled with a UE-specific scrambling sequence, resulting in a block of scrambled bits  $\tilde{b}(0), \dots, \tilde{b}(19)$  according to

$$\tilde{b}(i) = (b(i) + c(i)) \bmod 2$$

where the scrambling sequence  $c(i)$  is given by Section 7.2. The scrambling sequence generator shall be initialised with  $c_{\text{init}} = (\lfloor n_s/2 \rfloor + 1) \cdot (2N_{ID}^{\text{cell}} + 1) \cdot 2^{16} + n_{\text{RNTI}}$  at the start of each subframe where  $n_{\text{RNTI}}$  is C-RNTI.

The block of scrambled bits  $\tilde{b}(0), \dots, \tilde{b}(19)$  shall be QPSK modulated as described in Section 7.1, resulting in a block of complex-valued modulation symbols  $d(0), \dots, d(9)$ .

Each complex-valued symbol  $d(0), \dots, d(9)$  shall be multiplied with a cyclically shifted length  $N_{\text{seq}}^{PUCCH} = 12$  sequence  $r_{u,v}^{(\alpha)}(n)$  according to

$$\begin{aligned} z(N_{\text{seq}}^{PUCCH} \cdot n + i) &= d(n) \cdot r_{u,v}^{(\alpha)}(i) \\ n &= 0, 1, \dots, 9 \\ i &= 0, 1, \dots, N_{\text{sc}}^{\text{RB}} - 1 \end{aligned}$$

where  $r_{u,v}^{(\alpha)}(i)$  is defined by section 5.5.1 with  $M_{\text{sc}}^{\text{RS}} = N_{\text{seq}}^{PUCCH}$ .

Resources used for transmission of PUCCH formats 2/2a/2b are identified by a resource index  $n_{\text{PUCCH}}^{(2)}$  from which the cyclic shift  $\alpha(n_s, l)$  is determined according to

$$\alpha(n_s, l) = 2\pi \cdot n_{\text{cs}}(n_s, l) / N_{\text{sc}}^{\text{RB}}$$

where

$$n_{\text{cs}}(n_s, l) = (n_{\text{cs}}^{\text{cell}}(n_s, l) + n'(n_s)) \bmod N_{\text{sc}}^{\text{RB}}$$

and

$$n'(n_s) = \begin{cases} n_{\text{PUCCH}}^{(2)} \bmod N_{\text{sc}}^{\text{RB}} & \text{if } n_{\text{PUCCH}}^{(2)} < N_{\text{sc}}^{\text{RB}} N_{\text{RB}}^{(2)} \\ (n_{\text{PUCCH}}^{(2)} + N_{\text{cs}}^{(1)} + 1) \bmod N_{\text{sc}}^{\text{RB}} & \text{otherwise} \end{cases}$$

for  $n_s \bmod 2 = 0$  and by

$$n'(n_s) = \begin{cases} \left[ \left[ N_{\text{sc}}^{\text{RB}} (n'(n_s - 1) + 1) \right] \bmod (N_{\text{sc}}^{\text{RB}} + 1) - 1 \right] & \text{if } n_{\text{PUCCH}}^{(2)} < N_{\text{sc}}^{\text{RB}} N_{\text{RB}}^{(2)} \\ (N_{\text{sc}}^{\text{RB}} - 2 - n_{\text{PUCCH}}^{(2)}) \bmod N_{\text{sc}}^{\text{RB}} & \text{otherwise} \end{cases}$$

for  $n_s \bmod 2 = 1$ .

For PUCCH formats 2a and 2b, supported for normal cyclic prefix only, the bit(s)  $b(20), \dots, b(M_{\text{bit}} - 1)$  shall be modulated as described in Table 5.4.2-1 resulting in a single modulation symbol  $d(10)$  used in the generation of the reference-signal for PUCCH format 2a and 2b as described in Section 5.5.2.2.1.

**Table 5.4.2-1: Modulation symbol  $d(10)$  for PUCCH formats 2a and 2b.**

PUCCH format	$b(20), \dots, b(M_{\text{bit}} - 1)$	$d(10)$
2a	0	1
	1	-1
2b	00	1
	01	$-j$
	10	$j$
	11	-1

### 5.4.3 Mapping to physical resources

The block of complex-valued symbols  $z(i)$  shall be multiplied with the amplitude scaling factor  $\beta_{\text{PUCCH}}$  in order to conform to the transmit power  $P_{\text{PUCCH}}$  specified in Section 5.1.2.1 in [4], and mapped in sequence starting with  $z(0)$  to resource elements. PUCCH uses one resource block in each of the two slots in a subframe. Within the physical resource block used for transmission, the mapping of  $z(i)$  to resource elements  $(k, l)$  not used for transmission of reference signals shall be in increasing order of first  $k$ , then  $l$  and finally the slot number, starting with the first slot in the subframe.

The physical resource blocks to be used for transmission of PUCCH in slot  $n_s$  is given by

$$n_{\text{PRB}} = \begin{cases} \left\lfloor \frac{m}{2} \right\rfloor & \text{if } (m + n_s \bmod 2) \bmod 2 = 0 \\ N_{\text{RB}}^{\text{UL}} - 1 - \left\lfloor \frac{m}{2} \right\rfloor & \text{if } (m + n_s \bmod 2) \bmod 2 = 1 \end{cases}$$

where the variable  $m$  depends on the PUCCH format. For formats 1, 1a and 1b

$$m = \begin{cases} N_{\text{RB}}^{(2)} & \text{if } n_{\text{PUCCH}}^{(1)} < c \cdot N_{\text{cs}}^{(1)} / \Delta_{\text{shift}}^{\text{PUCCH}} \\ \left\lfloor \frac{n_{\text{PUCCH}}^{(1)} - c \cdot N_{\text{cs}}^{(1)} / \Delta_{\text{shift}}^{\text{PUCCH}}}{c \cdot N_{\text{sc}}^{\text{RB}} / \Delta_{\text{shift}}^{\text{PUCCH}}} \right\rfloor + N_{\text{RB}}^{(2)} + \left\lfloor \frac{N_{\text{cs}}^{(1)}}{8} \right\rfloor & \text{otherwise} \end{cases}$$

$$c = \begin{cases} 3 & \text{normal cyclic prefix} \\ 2 & \text{extended cyclic prefix} \end{cases}$$

and for formats 2, 2a and 2b

$$m = \left\lfloor n_{\text{PUCCH}}^{(2)} / N_{\text{sc}}^{\text{RB}} \right\rfloor$$

Mapping of modulation symbols for the physical uplink control channel is illustrated in Figure 5.4.3-1.

In case of simultaneous transmission of sounding reference signal and PUCCH format 1, 1a or 1b, one SC-FDMA symbol on PUCCH shall be punctured.

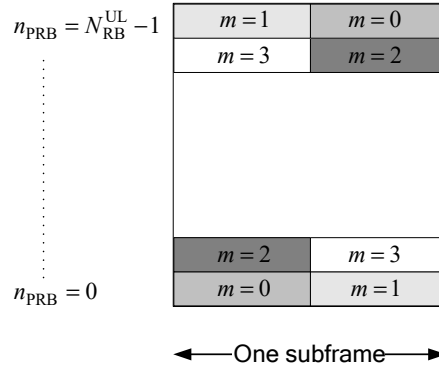

Figure 5.4.3-1: Mapping to physical resource blocks for PUCCH.

## 5.5 Reference signals

Two types of uplink reference signals are supported:

- Demodulation reference signal, associated with transmission of PUSCH or PUCCH
- Sounding reference signal, not associated with transmission of PUSCH or PUCCH

The same set of base sequences is used for demodulation and sounding reference signals.

### 5.5.1 Generation of the reference signal sequence

Reference signal sequence  $r_{u,v}^{(\alpha)}(n)$  is defined by a cyclic shift  $\alpha$  of a base sequence  $\bar{r}_{u,v}(n)$  according to

$$r_{u,v}^{(\alpha)}(n) = e^{j\alpha n} \bar{r}_{u,v}(n), \quad 0 \leq n < M_{\text{sc}}^{\text{RS}}$$

where  $M_{\text{sc}}^{\text{RS}} = mN_{\text{sc}}^{\text{RB}}$  is the length of the reference signal sequence and  $1 \leq m \leq N_{\text{RB}}^{\text{max,UL}}$ . Multiple reference signal sequences are defined from a single base sequence through different values of  $\alpha$ .

Base sequences  $\bar{r}_{u,v}(n)$  are divided into groups, where  $u \in \{0,1,\dots,29\}$  is the group number and  $v$  is the base sequence number within the group, such that each group contains one base sequence ( $v=0$ ) of each length  $M_{\text{sc}}^{\text{RS}} = mN_{\text{sc}}^{\text{RB}}$ ,  $1 \leq m \leq 5$  and two base sequences ( $v=0,1$ ) of each length  $M_{\text{sc}}^{\text{RS}} = mN_{\text{sc}}^{\text{RB}}$ ,  $6 \leq m \leq N_{\text{RB}}^{\text{max,UL}}$ . The sequence group number  $u$  and the number  $v$  within the group may vary in time as described in Sections 5.5.1.3 and 5.5.1.4, respectively. The definition of the base sequence  $\bar{r}_{u,v}(0), \dots, \bar{r}_{u,v}(M_{\text{sc}}^{\text{RS}} - 1)$  depends on the sequence length  $M_{\text{sc}}^{\text{RS}}$ .

#### 5.5.1.1 Base sequences of length $3N_{\text{sc}}^{\text{RB}}$ or larger

For  $M_{\text{sc}}^{\text{RS}} \geq 3N_{\text{sc}}^{\text{RB}}$ , the base sequence  $\bar{r}_{u,v}(0), \dots, \bar{r}_{u,v}(M_{\text{sc}}^{\text{RS}} - 1)$  is given by

$$\bar{r}_{u,v}(n) = x_q(n \bmod N_{\text{ZC}}^{\text{RS}}), \quad 0 \leq n < M_{\text{sc}}^{\text{RS}}$$

where the  $q^{\text{th}}$  root Zadoff-Chu sequence is defined by

$$x_q(m) = e^{-j \frac{\pi q m(m+1)}{N_{ZC}^{RS}}}, \quad 0 \leq m \leq N_{ZC}^{RS} - 1$$

with  $q$  given by

$$q = \lfloor \bar{q} + 1/2 \rfloor + v \cdot (-1)^{\lfloor 2\bar{q} \rfloor}$$

$$\bar{q} = N_{ZC}^{RS} \cdot (u + 1) / 31$$

The length  $N_{ZC}^{RS}$  of the Zadoff-Chu sequence is given by the largest prime number such that  $N_{ZC}^{RS} < M_{sc}^{RS}$ .

### 5.5.1.2 Base sequences of length less than $3N_{sc}^{RB}$

For  $M_{sc}^{RS} = N_{sc}^{RB}$  and  $M_{sc}^{RS} = 2N_{sc}^{RB}$ , base sequence is given by

$$\bar{r}_{u,v}(n) = e^{j\varphi(n)\pi/4}, \quad 0 \leq n \leq M_{sc}^{RS} - 1$$

where the value of  $\varphi(n)$  is given by Table 5.5.1.2-1 and Table 5.5.1.2-2 for  $M_{sc}^{RS} = N_{sc}^{RB}$  and  $M_{sc}^{RS} = 2N_{sc}^{RB}$ , respectively.

**Table 5.5.1.2-1: Definition of  $\varphi(n)$  for  $M_{sc}^{RS} = N_{sc}^{RB}$ .**

$u$	$\varphi(0), \dots, \varphi(11)$											
0	-1	1	3	-3	3	3	1	1	3	1	-3	3
1	1	1	3	3	3	-1	1	-3	-3	1	-3	3
2	1	1	-3	-3	-3	-1	-3	-3	1	-3	1	-1
3	-1	1	1	1	1	-1	-3	-3	1	-3	3	-1
4	-1	3	1	-1	1	-1	-3	-1	1	-1	1	3
5	1	-3	3	-1	-1	1	1	-1	-1	3	-3	1
6	-1	3	-3	-3	-3	3	1	-1	3	3	-3	1
7	-3	-1	-1	-1	1	-3	3	-1	1	-3	3	1
8	1	-3	3	1	-1	-1	-1	1	1	3	-1	1
9	1	-3	-1	3	3	-1	-3	1	1	1	1	1
10	-1	3	-1	1	1	-3	-3	-1	-3	-3	3	-1
11	3	1	-1	-1	3	3	-3	1	3	1	3	3
12	1	-3	1	1	-3	1	1	1	-3	-3	-3	1
13	3	3	-3	3	-3	1	1	3	-1	-3	3	3
14	-3	1	-1	-3	-1	3	1	3	3	3	-1	1
15	3	-1	1	-3	-1	-1	1	1	3	1	-1	-3
16	1	3	1	-1	1	3	3	3	-1	-1	3	-1
17	-3	1	1	3	-3	3	-3	-3	3	1	3	-1
18	-3	3	1	1	-3	1	-3	-3	-1	-1	1	-3
19	-1	3	1	3	1	-1	-1	3	-3	-1	-3	-1
20	-1	-3	1	1	1	1	3	1	-1	1	-3	-1
21	-1	3	-1	1	-3	-3	-3	-3	-3	1	-1	-3
22	1	1	-3	-3	-3	-3	-1	3	-3	1	-3	3
23	1	1	-1	-3	-1	-3	1	-1	1	3	-1	1
24	1	1	3	1	3	3	-1	1	-1	-3	-3	1
25	1	-3	3	3	1	3	3	1	-3	-1	-1	3
26	1	3	-3	-3	3	-3	1	-1	-1	3	-1	-3
27	-3	-1	-3	-1	-3	3	1	-1	1	3	-3	-3
28	-1	3	-3	3	-1	3	3	-3	3	3	-1	-1
29	3	-3	-3	-1	-1	-3	-1	3	-3	3	1	-1

Table 5.5.1.2-2: Definition of  $\varphi(n)$  for  $M_{sc}^{RS} = 2N_{sc}^{RB}$ .

$u$	$\varphi(0), \dots, \varphi(23)$																							
0	-1	3	1	-3	3	-1	1	3	-3	3	1	3	-3	3	1	1	-1	1	3	-3	3	-3	-1	-3
1	-3	3	-3	-3	-3	1	-3	-3	3	-1	1	1	3	1	-1	3	-3	-3	1	3	1	1	-3	
2	3	-1	3	3	1	1	-3	3	3	3	3	1	-1	3	-1	1	1	-1	-3	-1	-1	1	3	3
3	-1	-3	1	1	3	-3	1	1	-3	-1	-1	1	3	1	3	1	-1	3	1	1	-3	-1	-3	-1
4	-1	-1	-1	-3	-3	-1	1	1	3	3	-1	3	-1	1	-1	-3	1	-1	-3	-3	1	-3	-1	-1
5	-3	1	1	3	-1	1	3	1	-3	1	-3	1	1	-1	-1	3	-1	-3	3	-3	-3	-3	1	1
6	1	1	-1	-1	3	-3	-3	3	-3	1	-1	-1	1	-1	1	1	-1	-3	-1	1	-1	3	-1	-3
7	-3	3	3	-1	-1	-3	-1	3	1	3	1	3	1	1	-1	3	1	-1	1	3	-3	-1	-1	1
8	-3	1	3	-3	1	-1	-3	3	-3	3	-1	-1	-1	-1	1	-3	-3	-3	1	-3	-3	-3	1	-3
9	1	1	-3	3	3	-1	-3	-1	3	-3	3	3	3	-1	1	1	-3	1	-1	1	1	-3	1	1
10	-1	1	-3	-3	3	-1	3	-1	-1	-3	-3	-3	-1	-3	-3	1	-1	1	3	3	-1	1	-1	3
11	1	3	3	-3	-3	1	3	1	-1	-3	-3	-3	3	3	-3	3	3	-1	-3	3	-1	1	-3	1
12	1	3	3	1	1	1	-1	-1	1	-3	3	-1	1	1	-3	3	3	-1	-3	3	-1	-3	-1	-3
13	3	-1	-1	-1	-1	-3	-1	3	3	1	-1	1	3	3	3	-1	1	1	-3	1	3	-1	-3	3
14	-3	-3	3	1	3	1	-3	3	1	3	1	1	3	3	-1	-1	-3	1	-3	-1	3	1	1	3
15	-1	-1	1	-3	1	3	-3	1	-1	-3	-1	3	1	3	1	-1	-3	-3	-1	-1	-3	-3	-3	-1
16	-1	-3	3	-1	-1	-1	-1	1	1	-3	3	1	3	3	1	-1	1	-3	1	-3	1	1	-3	-1
17	1	3	-1	3	3	-1	-3	1	-1	-3	3	3	3	-1	1	1	3	-1	-3	-1	3	-1	-1	-1
18	1	1	1	1	1	-1	3	-1	-3	1	1	3	-3	1	-3	-1	1	1	-3	-3	3	1	1	-3
19	1	3	3	1	-1	-3	3	-1	3	3	3	-3	1	-1	1	-1	-3	-1	1	3	-1	3	-3	-3
20	-1	-3	3	-3	-3	-3	-1	-1	-3	-1	-3	3	1	3	-3	-1	3	-1	1	-1	3	-3	1	-1
21	-3	-3	1	1	-1	1	-1	1	-1	3	1	-3	-1	1	-1	1	-1	-1	3	3	-3	-1	1	-3
22	-3	-1	-3	3	1	-1	-3	-1	-3	-3	3	-3	3	-3	-1	1	3	1	-3	1	3	3	-1	-3
23	-1	-1	-1	-1	3	3	3	1	3	3	-3	1	3	-1	3	-1	3	3	-3	3	1	-1	3	3
24	1	-1	3	3	-1	-3	3	-3	-1	-1	3	-1	3	-1	-1	1	1	1	1	-1	-1	-3	-1	3
25	1	-1	1	-1	3	-1	3	1	1	-1	-1	-3	1	1	-3	1	3	-3	1	1	-3	-3	-1	-1
26	-3	-1	1	3	1	1	-3	-1	-1	-3	3	-3	3	1	-3	3	-3	1	-1	1	-3	1	1	1
27	-1	-3	3	3	1	1	3	-1	-3	-1	-1	-1	3	1	-3	-1	3	-3	-1	-3	-1	-3	-1	-3
28	-1	-3	-1	-1	1	-3	-1	-1	1	-1	-3	1	1	-3	1	-3	-3	3	1	1	-1	3	-1	-1
29	1	1	-1	-1	-3	-1	3	-1	3	-1	1	3	1	-1	3	1	3	-3	-3	1	-1	-1	1	3

### 5.5.1.3 Group hopping

The sequence-group number  $u$  in slot  $n_s$  is defined by a group hopping pattern  $f_{gh}(n_s)$  and a sequence-shift pattern  $f_{ss}$  according to

$$u = (f_{gh}(n_s) + f_{ss}) \bmod 30$$

There are 17 different hopping patterns and 30 different sequence-shift patterns. Sequence-group hopping can be enabled or disabled by means of the parameter *Group-hopping-enabled* provided by higher layers. PUCCH and PUSCH have the same hopping pattern but may have different sequence-shift patterns.

The group-hopping pattern  $f_{gh}(n_s)$  is the same for PUSCH and PUCCH and given by

$$f_{gh}(n_s) = \begin{cases} 0 & \text{if group hopping is disabled} \\ \left( \sum_{i=0}^7 c(8n_s + i) \cdot 2^i \right) \bmod 30 & \text{if group hopping is enabled} \end{cases}$$

where the pseudo-random sequence  $c(i)$  is defined by section 7.2. The pseudo-random sequence generator shall be

initialized with  $c_{\text{init}} = \left\lfloor \frac{N_{\text{ID}}^{\text{cell}}}{30} \right\rfloor$  at the beginning of each radio frame.

The sequence-shift pattern  $f_{ss}$  definition differs between PUCCH and PUSCH.

For PUCCH, the sequence-shift pattern  $f_{ss}^{\text{PUCCH}}$  is given by  $f_{ss}^{\text{PUCCH}} = N_{\text{ID}}^{\text{cell}} \bmod 30$ .

For PUSCH, the sequence-shift pattern  $f_{ss}^{\text{PUSCH}}$  is given by  $f_{ss}^{\text{PUSCH}} = (f_{ss}^{\text{PUCCH}} + \Delta_{ss}) \bmod 30$ , where  $\Delta_{ss} \in \{0,1,\dots,29\}$  is configured by higher layers.

### 5.5.1.4 Sequence hopping

Sequence hopping only applies for reference-signals of length  $M_{sc}^{\text{RS}} \geq 6N_{sc}^{\text{RB}}$ .

For reference-signals of length  $M_{sc}^{\text{RS}} < 6N_{sc}^{\text{RB}}$ , the base sequence number  $v$  within the base sequence group is given by  $v = 0$ .

For reference-signals of length  $M_{sc}^{\text{RS}} \geq 6N_{sc}^{\text{RB}}$ , the base sequence number  $v$  within the base sequence group in slot  $n_s$  is defined by

$$v = \begin{cases} c(n_s) & \text{if group hopping is disabled and sequence hopping is enabled} \\ 0 & \text{otherwise} \end{cases}$$

where the pseudo-random sequence  $c(i)$  is given by section 7.2. The parameter *Sequence-hopping-enabled* provided by higher layers determines if sequence hopping is enabled or not. The pseudo-random sequence generator shall be

initialized with  $c_{\text{init}} = \left\lfloor \frac{N_{\text{ID}}^{\text{cell}}}{30} \right\rfloor \cdot 2^5 + f_{ss}^{\text{PUSCH}}$  at the beginning of each radio frame.

## 5.5.2 Demodulation reference signal

### 5.5.2.1 Demodulation reference signal for PUSCH

#### 5.5.2.1.1 Reference signal sequence

The demodulation reference signal sequence  $r^{\text{PUSCH}}(\cdot)$  for PUSCH is defined by

$$r^{\text{PUSCH}}(m \cdot M_{sc}^{\text{RS}} + n) = r_{u,v}^{(\alpha)}(n)$$

where

$$\begin{aligned} m &= 0,1 \\ n &= 0,\dots,M_{sc}^{\text{RS}} - 1 \end{aligned}$$

and

$$M_{sc}^{\text{RS}} = M_{sc}^{\text{PUSCH}}$$

Section 5.5.1 defines the sequence  $r_{u,v}^{(\alpha)}(0), \dots, r_{u,v}^{(\alpha)}(M_{sc}^{\text{RS}} - 1)$ .

The cyclic shift  $\alpha$  in a slot  $n_s$  is given as  $\alpha = 2\pi n_{cs} / 12$  with

$$n_{cs} = (n_{\text{DMRS}}^{(1)} + n_{\text{DMRS}}^{(2)} + n_{\text{PRS}}(n_s)) \bmod 12$$

where the values of  $n_{\text{DMRS}}^{(1)}$  is given by Table 5.5.2.1.1-2 according to the parameter *cyclicShift* provided by higher layers,  $n_{\text{DMRS}}^{(2)}$  is given by the cyclic shift for DMRS field in most recent DCI format 0 [3] for the transport block associated with the corresponding PUSCH transmission where the values of  $n_{\text{DMRS}}^{(2)}$  is given in Table 5.5.2.1.1-1. For a semi-persistently configured PUSCH transmission on subframe  $n$  in the absence of a corresponding PDCCH with a

DCI Format 0 in subframe  $n - k_{PUSCH}$  or a PUSCH transmission associated with a random access response grant,  $n_{DMRS}^{(2)}$  is set to zero where  $k_{PUSCH}$  is as defined in section 8 [4].  $n_{PRS}(n_s)$  is given by

$$n_{PRS}(n_s) = \sum_{i=0}^7 c(8N_{\text{symb}}^{\text{UL}} \cdot n_s + i) \cdot 2^i$$

where the pseudo-random sequence  $c(i)$  is defined by section 7.2. The application of  $c(i)$  is cell-specific. The pseudo-

random sequence generator shall be initialized with  $c_{\text{init}} = \left\lfloor \frac{N_{\text{ID}}^{\text{cell}}}{30} \right\rfloor \cdot 2^5 + f_{\text{ss}}^{\text{PUSCH}}$  at the beginning of each radio frame.

**Table 5.5.2.1.1-1: Mapping of Cyclic Shift Field in DCI format 0 to  $n_{DMRS}^{(2)}$  Values.**

Cyclic Shift Field in DCI format 0 [3]	$n_{DMRS}^{(2)}$
000	0
001	6
010	3
011	4
100	2
101	8
110	10
111	9

**Table 5.5.2.1.1-2: Mapping of *cyclicShift* to  $n_{DMRS}^{(1)}$  Values.**

<i>cyclicShift</i>	$n_{DMRS}^{(1)}$
0	0
1	2
2	3
3	4
4	6
5	8
6	9
7	10

#### 5.5.2.1.2 Mapping to physical resources

The sequence  $r^{\text{PUSCH}}(\cdot)$  shall be multiplied with the amplitude scaling factor  $\beta_{\text{PUSCH}}$  and mapped in sequence starting with  $r^{\text{PUSCH}}(0)$  to the same set of physical resource blocks used for the corresponding PUSCH transmission defined in

Section 5.3.4. The mapping to resource elements  $(k, l)$ , with  $l = 3$  for normal cyclic prefix and  $l = 2$  for extended cyclic prefix, in the subframe shall be in increasing order of first  $k$ , then the slot number.

### 5.5.2.2 Demodulation reference signal for PUCCH

#### 5.5.2.2.1 Reference signal sequence

The demodulation reference signal sequence  $r^{\text{PUCCH}}(\cdot)$  for PUCCH is defined by

$$r^{\text{PUCCH}}(m' N_{\text{RS}}^{\text{PUCCH}} M_{\text{sc}}^{\text{RS}} + m M_{\text{sc}}^{\text{RS}} + n) = \bar{w}(m) z(m) r_{u,v}^{(\alpha)}(n)$$

where

$$\begin{aligned} m &= 0, \dots, N_{\text{RS}}^{\text{PUCCH}} - 1 \\ n &= 0, \dots, M_{\text{sc}}^{\text{RS}} - 1 \\ m' &= 0, 1 \end{aligned}$$

For PUCCH format 2a and 2b,  $z(m)$  equals  $d(10)$  for  $m = 1$ , where  $d(10)$  is defined in Section 5.4.2. For all other cases,  $z(m) = 1$ .

The sequence  $r_{u,v}^{(\alpha)}(n)$  is given by Section 5.5.1 with  $M_{\text{sc}}^{\text{RS}} = 12$  where the expression for the cyclic shift  $\alpha$  is determined by the PUCCH format.

For PUCCH formats 1, 1a and 1b,  $\alpha(n_s, l)$  is given by

$$\begin{aligned} \bar{n}_{\text{oc}}(n_s) &= \lfloor n'(n_s) \cdot \Delta_{\text{shift}}^{\text{PUCCH}} / N' \rfloor \\ \alpha(n_s, l) &= 2\pi \cdot \bar{n}_{\text{cs}}(n_s, l) / N_{\text{sc}}^{\text{RB}} \\ \bar{n}_{\text{cs}}(n_s, l) &= \begin{cases} \left[ n_{\text{cs}}^{\text{cell}}(n_s, l) + \left( n'(n_s) \cdot \Delta_{\text{shift}}^{\text{PUCCH}} + (\bar{n}_{\text{oc}}(n_s) \bmod \Delta_{\text{shift}}^{\text{PUCCH}}) \right) \bmod N' \right] \bmod N_{\text{sc}}^{\text{RB}} & \text{for normal cyclic prefix} \\ \left[ n_{\text{cs}}^{\text{cell}}(n_s, l) + \left( n'(n_s) \cdot \Delta_{\text{shift}}^{\text{PUCCH}} + \bar{n}_{\text{oc}}(n_s) \right) \bmod N' \right] \bmod N_{\text{sc}}^{\text{RB}} & \text{for extended cyclic prefix} \end{cases} \end{aligned}$$

where  $n'(n_s)$ ,  $N'$ ,  $\Delta_{\text{shift}}^{\text{PUCCH}}$  and  $n_{\text{cs}}^{\text{cell}}(n_s, l)$  are defined by Section 5.4.1. The number of reference symbols per slot  $N_{\text{RS}}^{\text{PUCCH}}$  and the sequence  $\bar{w}(n)$  are given by Table 5.5.2.2.1-1 and 5.5.2.2.1-2, respectively.

For PUCCH formats 2, 2a and 2b,  $\alpha(n_s, l)$  is defined by Section 5.4.2. The number of reference symbols per slot  $N_{\text{RS}}^{\text{PUCCH}}$  and the sequence  $\bar{w}(n)$  are given by Table 5.5.2.2.1-1 and 5.5.2.2.1-3, respectively.

**Table 5.5.2.2.1-1: Number of PUCCH demodulation reference symbols per slot  $N_{\text{RS}}^{\text{PUCCH}}$ .**

PUCCH format	Normal cyclic prefix	Extended cyclic prefix
1, 1a, 1b	3	2
2	2	1
2a, 2b	2	N/A

**Table 5.5.2.2.1-2: Orthogonal sequences  $[\bar{w}(0) \dots \bar{w}(N_{RS}^{PUCCH} - 1)]$  for PUCCH formats 1, 1a and 1b.**

Sequence index $\bar{n}_{oc}(n_s)$	Normal cyclic prefix	Extended cyclic prefix
0	$[1 \ 1 \ 1]$	$[1 \ 1]$
1	$[1 \ e^{j2\pi/3} \ e^{j4\pi/3}]$	$[1 \ -1]$
2	$[1 \ e^{j4\pi/3} \ e^{j2\pi/3}]$	N/A

**Table 5.5.2.2.1-3: Orthogonal sequences  $[\bar{w}(0) \dots \bar{w}(N_{RS}^{PUCCH} - 1)]$  for PUCCH formats 2, 2a, 2b.**

Normal cyclic prefix	Extended cyclic prefix
$[1 \ 1]$	$[1]$

### 5.5.2.2.2 Mapping to physical resources

The sequence  $r^{PUCCH}(\cdot)$  shall be multiplied with the amplitude scaling factor  $\beta_{PUCCH}$  and mapped in sequence starting with  $r^{PUCCH}(0)$  to resource elements  $(k, l)$ . The mapping shall be in increasing order of first  $k$ , then  $l$  and finally the slot number. The same set of values for  $k$  as for the corresponding PUCCH transmission shall be used. The values of the symbol index  $l$  in a slot are given by Table 5.5.2.2.2-1.

**Table 5.5.2.2.2-1: Demodulation reference signal location for different PUCCH formats**

PUCCH format	Set of values for $l$	
	Normal cyclic prefix	Extended cyclic prefix
1, 1a, 1b	2, 3, 4	2, 3
2	1, 5	3
2a, 2b	1, 5	N/A

## 5.5.3 Sounding reference signal

### 5.5.3.1 Sequence generation

The sounding reference signal sequence  $r^{SRS}(n) = r_{u,\nu}^{(\alpha)}(n)$  is defined by Section 5.5.1, where  $u$  is the PUCCH sequence-group number defined in Section 5.5.1.3 and  $\nu$  is the base sequence number defined in Section 5.5.1.4. The cyclic shift  $\alpha$  of the sounding reference signal is given as

$$\alpha = 2\pi \frac{n_{SRS}^{cs}}{8},$$

where  $n_{SRS}^{cs}$  is configured for each UE by higher layers and  $n_{SRS}^{cs} = 0, 1, 2, 3, 4, 5, 6, 7$ .

### 5.5.3.2 Mapping to physical resources

The sequence shall be multiplied with the amplitude scaling factor  $\beta_{SRS}$  in order to conform to the transmit power  $P_{SRS}$  specified in Section 5.1.3.1 in [4], and mapped in sequence starting with  $r^{SRS}(0)$  to resource elements  $(k, l)$  according to

$$a_{2k+k_0,l} = \begin{cases} \beta_{SRS} r^{SRS}(k) & k = 0, 1, \dots, M_{sc,b}^{RS} - 1 \\ 0 & \text{otherwise} \end{cases}$$

where  $k_0$  is the frequency-domain starting position of the sounding reference signal and for  $b = B_{SRS}$   $M_{sc,b}^{RS}$  is the length of the sounding reference signal sequence defined as

$$M_{sc,b}^{RS} = m_{SRS,b} N_{sc}^{RB} / 2$$

where  $m_{SRS,b}$  is given by Table 5.5.3.2-1 through Table 5.5.3.2-4 for each uplink bandwidth  $N_{RB}^{UL}$ . The cell-specific parameter *srs-BandwidthConfig*  $C_{SRS} \in \{0,1,2,3,4,5,6,7\}$  and the UE-specific parameter *srs-Bandwidth*  $B_{SRS} \in \{0,1,2,3\}$  are given by higher layers. For UpPTS,  $m_{SRS,0}$  shall be reconfigured to  $m_{SRS,0}^{max} = \max_{c \in C} \{m_{SRS,0}^c\} \leq (N_{RB}^{UL} - 6N_{RA})$  if this reconfiguration is enabled by the cell specific parameter *srsMaxUpPts* given by higher layers, otherwise if the reconfiguration is disabled  $m_{SRS,0}^{max} = m_{SRS,0}$ , where  $c$  is a SRS BW configuration and  $C_{SRS}$  is the set of SRS BW configurations from the Tables 5.5.3.2-1 to 5.5.3.2-4 for each uplink bandwidth  $N_{RB}^{UL}$ ,  $N_{RA}$  is the number of format 4 PRACH in the addressed UpPTS and derived from Table 5.7.1-4.

The frequency-domain starting position  $k_0$  is defined by

$$k_0 = k'_0 + \sum_{b=0}^{B_{SRS}} 2M_{sc,b}^{RS} n_b$$

where for normal uplink subframes  $k'_0 = \left( \lfloor N_{RB}^{UL} / 2 \rfloor - m_{SRS,0} / 2 \right) N_{sc}^{RB} + k_{TC}$ , for UpPTS  $k'_0$  is defined by:

$$k'_0 = \begin{cases} (N_{RB}^{UL} - m_{SRS,0}^{max}) N_{sc}^{RB} + k_{TC} & \text{if } ((n_f \bmod 2) \times (2 - N_{SP}) + n_{hf}) \bmod 2 = 0 \\ k_{TC} & \text{otherwise} \end{cases}$$

$k_{TC} \in \{0,1\}$  is the parameter *transmissionComb* provided by higher layers for the UE, and  $n_b$  is frequency position index.  $n_{hf}$  is equal to 0 for UpPTS in first half frame, and equal to 1 for UpPTS in second half frame.

The frequency hopping of the sounding reference signal is configured by the parameter *srs-HoppingBandwidth*,  $b_{hop} \in \{0,1,2,3\}$ , provided by higher layers. If frequency hopping of the sounding reference signal is not enabled (i.e.,  $b_{hop} \geq B_{SRS}$ ), the frequency position index  $n_b$  remains constant (unless re-configured) and is defined by  $n_b = \lfloor 4n_{RRC} / m_{SRS,b} \rfloor \bmod N_b$  where the parameter *freqDomainPosition*  $n_{RRC}$  is given by higher layers for the UE. If frequency hopping of the sounding reference signal is enabled (i.e.,  $b_{hop} < B_{SRS}$ ), the frequency position indexes  $n_b$  are defined by

$$n_b = \begin{cases} \lfloor 4n_{RRC} / m_{SRS,b} \rfloor \bmod N_b & b \leq b_{hop} \\ \lfloor F_b(n_{SRS}) + \lfloor 4n_{RRC} / m_{SRS,b} \rfloor \rfloor \bmod N_b & \text{otherwise} \end{cases}$$

where  $N_b$  is given by Table 5.5.3.2-1 through Table 5.5.3.2-4 for each uplink bandwidth  $N_{RB}^{UL}$ ,

$$F_b(n_{SRS}) = \begin{cases} (N_b / 2) \left[ \frac{n_{SRS} \bmod \prod_{b'=b_{hop}}^b N_{b'}}{\prod_{b'=b_{hop}}^{b-1} N_{b'}} \right] + \left[ \frac{n_{SRS} \bmod \prod_{b'=b_{hop}}^b N_{b'}}{2 \prod_{b'=b_{hop}}^{b-1} N_{b'}} \right] & \text{if } N_b \text{ even} \\ \lfloor N_b / 2 \rfloor \lfloor n_{SRS} / \prod_{b'=b_{hop}}^{b-1} N_{b'} \rfloor & \text{if } N_b \text{ odd} \end{cases}$$

where  $N_{b_{hop}} = 1$  regardless of the  $N_b$  value on Table 5.5.3.2-1 through Table 5.5.3.2-4, and

$$n_{SRS} = \begin{cases} 2N_{SP}n_f + 2(N_{SP} - 1) \left\lfloor \frac{n_s}{10} \right\rfloor + \left\lfloor \frac{T_{offset}}{T_{offset\_max}} \right\rfloor, & \text{for 2ms SRS periodicity of frame structure 2} \\ \lfloor (n_f \times 10 + \lfloor n_s / 2 \rfloor) / T_{SRS} \rfloor & \text{otherwise} \end{cases}$$

counts the number of UE-specific SRS transmissions, where  $T_{\text{SRS}}$  is UE-specific periodicity of SRS transmission defined in section 8.2 of [4],  $T_{\text{offset}}$  is SRS subframe offset defined in Table 8.2-2 of [4] and  $T_{\text{offset\_max}}$  is the maximum value of  $T_{\text{offset}}$  for a certain configuration of SRS subframe offset.

For all subframes other than special subframes, the sounding reference signal shall be transmitted in the last symbol of the subframe.

**Table 5.5.3.2-1:**  $m_{\text{SRS},b}$  and  $N_b$ ,  $b=0,1,2,3$ , values for the uplink bandwidth of  $6 \leq N_{\text{RB}}^{\text{UL}} \leq 40$ .

SRS bandwidth configuration $C_{\text{SRS}}$	SRS-Bandwidth $B_{\text{SRS}} = 0$		SRS-Bandwidth $B_{\text{SRS}} = 1$		SRS-Bandwidth $B_{\text{SRS}} = 2$		SRS-Bandwidth $B_{\text{SRS}} = 3$	
	$m_{\text{SRS},0}$	$N_0$	$m_{\text{SRS},1}$	$N_1$	$m_{\text{SRS},2}$	$N_2$	$m_{\text{SRS},3}$	$N_3$
0	36	1	12	3	4	3	4	1
1	32	1	16	2	8	2	4	2
2	24	1	4	6	4	1	4	1
3	20	1	4	5	4	1	4	1
4	16	1	4	4	4	1	4	1
5	12	1	4	3	4	1	4	1
6	8	1	4	2	4	1	4	1
7	4	1	4	1	4	1	4	1

**Table 5.5.3.2-2:**  $m_{\text{SRS},b}$  and  $N_b$ ,  $b=0,1,2,3$ , values for the uplink bandwidth of  $40 < N_{\text{RB}}^{\text{UL}} \leq 60$ .

SRS bandwidth configuration $C_{\text{SRS}}$	SRS-Bandwidth $B_{\text{SRS}} = 0$		SRS-Bandwidth $B_{\text{SRS}} = 1$		SRS-Bandwidth $B_{\text{SRS}} = 2$		SRS-Bandwidth $B_{\text{SRS}} = 3$	
	$m_{\text{SRS},0}$	$N_0$	$m_{\text{SRS},1}$	$N_1$	$m_{\text{SRS},2}$	$N_2$	$m_{\text{SRS},3}$	$N_3$
0	48	1	24	2	12	2	4	3
1	48	1	16	3	8	2	4	2
2	40	1	20	2	4	5	4	1
3	36	1	12	3	4	3	4	1
4	32	1	16	2	8	2	4	2
5	24	1	4	6	4	1	4	1
6	20	1	4	5	4	1	4	1
7	16	1	4	4	4	1	4	1

**Table 5.5.3.2-3:**  $m_{\text{SRS},b}$  and  $N_b$ ,  $b=0,1,2,3$ , values for the uplink bandwidth of  $60 < N_{\text{RB}}^{\text{UL}} \leq 80$ .

SRS bandwidth configuration $C_{\text{SRS}}$	SRS-Bandwidth $B_{\text{SRS}} = 0$		SRS-Bandwidth $B_{\text{SRS}} = 1$		SRS-Bandwidth $B_{\text{SRS}} = 2$		SRS-Bandwidth $B_{\text{SRS}} = 3$	
	$m_{\text{SRS},0}$	$N_0$	$m_{\text{SRS},1}$	$N_1$	$m_{\text{SRS},2}$	$N_2$	$m_{\text{SRS},3}$	$N_3$
0	72	1	24	3	12	2	4	3
1	64	1	32	2	16	2	4	4
2	60	1	20	3	4	5	4	1
3	48	1	24	2	12	2	4	3
4	48	1	16	3	8	2	4	2
5	40	1	20	2	4	5	4	1
6	36	1	12	3	4	3	4	1
7	32	1	16	2	8	2	4	2

**Table 5.5.3.2-4:**  $m_{\text{SRS},b}$  and  $N_b$ ,  $b = 0,1,2,3$ , values for the uplink bandwidth of  $80 < N_{\text{RB}}^{\text{UL}} \leq 110$ .

SRS bandwidth configuration $C_{\text{SRS}}$	SRS-Bandwidth $B_{\text{SRS}} = 0$		SRS-Bandwidth $B_{\text{SRS}} = 1$		SRS-Bandwidth $B_{\text{SRS}} = 2$		SRS-Bandwidth $B_{\text{SRS}} = 3$	
	$m_{\text{SRS},0}$	$N_0$	$m_{\text{SRS},1}$	$N_1$	$m_{\text{SRS},2}$	$N_2$	$m_{\text{SRS},3}$	$N_3$
0	96	1	48	2	24	2	4	6
1	96	1	32	3	16	2	4	4
2	80	1	40	2	20	2	4	5
3	72	1	24	3	12	2	4	3
4	64	1	32	2	16	2	4	4
5	60	1	20	3	4	5	4	1
6	48	1	24	2	12	2	4	3
7	48	1	16	3	8	2	4	2

### 5.5.3.3 Sounding reference signal subframe configuration

The cell specific subframe configuration period  $T_{\text{SFC}}$  and the cell specific subframe offset  $\Delta_{\text{SFC}}$  for the transmission of sounding reference signals are listed in Tables 5.5.3.3-1 and 5.5.3.3-2, for FDD and TDD, respectively. Sounding reference signal subframes are the subframes satisfying  $\lfloor n_s / 2 \rfloor \bmod T_{\text{SFC}} \in \Delta_{\text{SFC}}$ . For TDD, sounding reference signal is transmitted only in configured UL subframes or UpPTS.

**Table 5.5.3.3-1: FDD sounding reference signal subframe configuration**

srsSubframeConfiguration	Binary	Configuration Period $T_{\text{SFC}}$ (subframes)	Transmission offset $\Delta_{\text{SFC}}$ (subframes)
0	0000	1	{0}
1	0001	2	{0}
2	0010	2	{1}
3	0011	5	{0}
4	0100	5	{1}
5	0101	5	{2}
6	0110	5	{3}
7	0111	5	{0,1}
8	1000	5	{2,3}
9	1001	10	{0}
10	1010	10	{1}
11	1011	10	{2}
12	1100	10	{3}
13	1101	10	{0,1,2,3,4,6,8}
14	1110	10	{0,1,2,3,4,5,6,8}

15	1111	reserved	reserved
----	------	----------	----------

**Table 5.5.3.3-2: TDD sounding reference signal subframe configuration**

srsSubframeConfiguration	Binary	Configuration Period $T_{SFC}$ (subframes)	Transmission offset $\Delta_{SFC}$ (subframes)
0	0000	5	{1}
1	0001	5	{1, 2}
2	0010	5	{1, 3}
3	0011	5	{1, 4}
4	0100	5	{1, 2, 3}
5	0101	5	{1, 2, 4}
6	0110	5	{1, 3, 4}
7	0111	5	{1, 2, 3, 4}
8	1000	10	{1, 2, 6}
9	1001	10	{1, 3, 6}
10	1010	10	{1, 6, 7}
11	1011	10	{1, 2, 6, 8}
12	1100	10	{1, 3, 6, 9}
13	1101	10	{1, 4, 6, 7}
14	1110	reserved	reserved
15	1111	reserved	reserved

## 5.6 SC-FDMA baseband signal generation

This section applies to all uplink physical signals and physical channels except the physical random access channel.

The time-continuous signal  $s_l(t)$  in SC-FDMA symbol  $l$  in an uplink slot is defined by

$$s_l(t) = \sum_{k=-\lfloor N_{RB}^{UL} N_{sc}^{RB} / 2 \rfloor}^{\lfloor N_{RB}^{UL} N_{sc}^{RB} / 2 \rfloor - 1} a_{k^{(-)}, l} \cdot e^{j2\pi(k+1/2)\Delta f(t - N_{CP,l} T_s)}$$

for  $0 \leq t < (N_{CP,l} + N) \times T_s$  where  $k^{(-)} = k + \lfloor N_{RB}^{UL} N_{sc}^{RB} / 2 \rfloor$ ,  $N = 2048$ ,  $\Delta f = 15$  kHz and  $a_{k,l}$  is the content of resource element  $(k, l)$ .

The SC-FDMA symbols in a slot shall be transmitted in increasing order of  $l$ , starting with  $l = 0$ , where SC-FDMA symbol  $l > 0$  starts at time  $\sum_{l'=0}^{l-1} (N_{CP,l'} + N) T_s$  within the slot.

Table 5.6-1 lists the values of  $N_{CP,l}$  that shall be used. Note that different SC-FDMA symbols within a slot may have different cyclic prefix lengths.

**Table 5.6-1: SC-FDMA parameters.**

Configuration	Cyclic prefix length $N_{CP,l}$
Normal cyclic prefix	160 for $l = 0$
	144 for $l = 1, 2, \dots, 6$
Extended cyclic prefix	512 for $l = 0, 1, \dots, 5$

## 5.7 Physical random access channel

### 5.7.1 Time and frequency structure

The physical layer random access preamble, illustrated in Figure 5.7.1-1, consists of a cyclic prefix of length  $T_{CP}$  and a sequence part of length  $T_{SEQ}$ . The parameter values are listed in Table 5.7.1-1 and depend on the frame structure and the random access configuration. Higher layers control the preamble format.

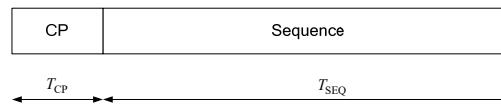

**Figure 5.7.1-1: Random access preamble format.**

**Table 5.7.1-1: Random access preamble parameters.**

Preamble format	$T_{CP}$	$T_{SEQ}$
0	$3168 \cdot T_s$	$24576 \cdot T_s$
1	$21024 \cdot T_s$	$24576 \cdot T_s$
2	$6240 \cdot T_s$	$2 \cdot 24576 \cdot T_s$
3	$21024 \cdot T_s$	$2 \cdot 24576 \cdot T_s$
4*	$448 \cdot T_s$	$4096 \cdot T_s$

\* Frame structure type 2 and special subframe configurations with UpPTS lengths  $4384 \cdot T_s$  and  $5120 \cdot T_s$  only.

The transmission of a random access preamble, if triggered by the MAC layer, is restricted to certain time and frequency resources. These resources are enumerated in increasing order of the subframe number within the radio frame and the physical resource blocks in the frequency domain such that index 0 correspond to the lowest numbered physical resource block and subframe within the radio frame. PRACH resources within the radio frame are indicated by a PRACH Resource Index, where the indexing is in the order of appearance in Table 5.7.1-2 and Table 5.7.1-4.

For frame structure type 1 with preamble format 0-3, there is at most one random access resource per subframe. Table 5.7.1-2 lists the preamble formats according to Table 5.7.1-1 and the subframes in which random access preamble transmission is allowed for a given configuration in frame structure type 1. The parameter *prach-ConfigurationIndex* is given by higher layers. The start of the random access preamble shall be aligned with the start of the corresponding uplink subframe at the UE assuming  $N_{TA} = 0$ , where  $N_{TA}$  is defined in section 8.1. For PRACH configuration 0, 1, 2, 15, 16, 17, 18, 31, 32, 33, 34, 47, 48, 49, 50 and 63 the UE may for handover purposes assume an absolute value of the relative time difference between radio frame  $i$  in the current cell and the target cell of less than  $153600 \cdot T_s$ . The first physical resource block  $n_{PRB}^{RA}$  allocated to the PRACH opportunity considered for preamble format 0, 1, 2 and 3 is

defined as  $n_{PRB}^{RA} = n_{PRB\ offset}^{RA}$ , where the parameter *prach-FrequencyOffset*  $n_{PRB\ offset}^{RA}$  is expressed as a physical resource block number configured by higher layers and fulfilling  $0 \leq n_{PRB\ offset}^{RA} \leq N_{RB}^{UL} - 6$ .

**Table 5.7.1-2: Frame structure type 1 random access configuration for preamble format 0-3.**

PRACH Configuration Index	Preamble Format	System frame number	Subframe number	PRACH Configuration Index	Preamble Format	System frame number	Subframe number
0	0	Even	1	32	2	Even	1
1	0	Even	4	33	2	Even	4
2	0	Even	7	34	2	Even	7
3	0	Any	1	35	2	Any	1
4	0	Any	4	36	2	Any	4
5	0	Any	7	37	2	Any	7
6	0	Any	1, 6	38	2	Any	1, 6
7	0	Any	2, 7	39	2	Any	2, 7
8	0	Any	3, 8	40	2	Any	3, 8
9	0	Any	1, 4, 7	41	2	Any	1, 4, 7
10	0	Any	2, 5, 8	42	2	Any	2, 5, 8
11	0	Any	3, 6, 9	43	2	Any	3, 6, 9
12	0	Any	0, 2, 4, 6, 8	44	2	Any	0, 2, 4, 6, 8
13	0	Any	1, 3, 5, 7, 9	45	2	Any	1, 3, 5, 7, 9
14	0	Any	0, 1, 2, 3, 4, 5, 6, 7, 8, 9	46	N/A	N/A	N/A
15	0	Even	9	47	2	Even	9
16	1	Even	1	48	3	Even	1
17	1	Even	4	49	3	Even	4
18	1	Even	7	50	3	Even	7
19	1	Any	1	51	3	Any	1
20	1	Any	4	52	3	Any	4
21	1	Any	7	53	3	Any	7
22	1	Any	1, 6	54	3	Any	1, 6
23	1	Any	2, 7	55	3	Any	2, 7
24	1	Any	3, 8	56	3	Any	3, 8
25	1	Any	1, 4, 7	57	3	Any	1, 4, 7
26	1	Any	2, 5, 8	58	3	Any	2, 5, 8
27	1	Any	3, 6, 9	59	3	Any	3, 6, 9
28	1	Any	0, 2, 4, 6, 8	60	N/A	N/A	N/A
29	1	Any	1, 3, 5, 7, 9	61	N/A	N/A	N/A
30	N/A	N/A	N/A	62	N/A	N/A	N/A
31	1	Even	9	63	3	Even	9

For frame structure type 2 with preamble format 0-4, there might be multiple random access resources in an UL subframe (or UpPTS for preamble format 4) depending on the UL/DL configuration [see table 4.2-2]. Table 5.7.1-3 lists PRACH configurations allowed for frame structure type 2 where the configuration index corresponds to a certain combination of preamble format, PRACH density value,  $D_{RA}$ , and version index,  $r_{RA}$ . The parameter *prach-ConfigurationIndex* is given by higher layers. For frame structure 2 PRACH configuration 0, 1, 2, 20, 21, 22, 30, 31, 32, 40, 41, 42, 48, 49 and 50, the UE may for handover purposes assume an absolute value of the relative time difference between radio frame  $i$  in the current cell and the target cell is less than  $153600 \cdot T_s$ .

Table 5.7.1-3: Frame structure type 2 random access configurations for preamble format 0-4

PRACH configuration Index	Preamble Format	Density Per 10 ms ( $D_{RA}$ )	Version ( $r_{RA}$ )	PRACH configuration Index	Preamble Format	Density Per 10 ms ( $D_{RA}$ )	Version ( $r_{RA}$ )
0	0	0.5	0	32	2	0.5	2
1	0	0.5	1	33	2	1	0
2	0	0.5	2	34	2	1	1
3	0	1	0	35	2	2	0
4	0	1	1	36	2	3	0
5	0	1	2	37	2	4	0
6	0	2	0	38	2	5	0
7	0	2	1	39	2	6	0
8	0	2	2	40	3	0.5	0
9	0	3	0	41	3	0.5	1
10	0	3	1	42	3	0.5	2
11	0	3	2	43	3	1	0
12	0	4	0	44	3	1	1
13	0	4	1	45	3	2	0
14	0	4	2	46	3	3	0
15	0	5	0	47	3	4	0
16	0	5	1	48	4	0.5	0
17	0	5	2	49	4	0.5	1
18	0	6	0	50	4	0.5	2
19	0	6	1	51	4	1	0
20	1	0.5	0	52	4	1	1
21	1	0.5	1	53	4	2	0
22	1	0.5	2	54	4	3	0
23	1	1	0	55	4	4	0
24	1	1	1	56	4	5	0
25	1	2	0	57	4	6	0
26	1	3	0	58	N/A	N/A	N/A
27	1	4	0	59	N/A	N/A	N/A
28	1	5	0	60	N/A	N/A	N/A
29	1	6	0	61	N/A	N/A	N/A
30	2	0.5	0	62	N/A	N/A	N/A
31	2	0.5	1	63	N/A	N/A	N/A

Table 5.7.1-4 lists the mapping to physical resources for the different random access opportunities needed for a certain PRACH density value,  $D_{RA}$ . Each quadruple of the format  $(f_{RA}, t_{RA}^0, t_{RA}^1, t_{RA}^2)$  indicates the location of a specific random access resource, where  $f_{RA}$  is a frequency resource index within the considered time instance,  $t_{RA}^0 = 0,1,2$  indicates whether the resource is reoccurring in all radio frames, in even radio frames, or in odd radio frames, respectively,  $t_{RA}^1 = 0,1$  indicates whether the random access resource is located in first half frame or in second half frame, respectively, and where  $t_{RA}^2$  is the uplink subframe number where the preamble starts, counting from 0 at the first uplink subframe between 2 consecutive downlink-to-uplink switch points, with the exception of preamble format 4 where  $t_{RA}^2$  is denoted as (\*). The start of the random access preamble formats 0-3 shall be aligned with the start of the corresponding uplink subframe at the UE assuming  $N_{TA} = 0$  and the random access preamble format 4 shall start  $4832 \cdot T_s$  before the end of the UpPTS at the UE, where the UpPTS is referenced to the UE's uplink frame timing assuming  $N_{TA} = 0$ .

The random access opportunities for each PRACH configuration shall be allocated in time first and then in frequency if and only if time multiplexing is not sufficient to hold all opportunities of a PRACH configuration needed for a certain density value  $D_{RA}$  without overlap in time. For preamble format 0-3, the frequency multiplexing shall be done according to

$$n_{PRB}^{RA} = \begin{cases} n_{PRB\ offset}^{RA} + 6 \left\lfloor \frac{f_{RA}}{2} \right\rfloor, & \text{if } f_{RA} \bmod 2 = 0 \\ N_{RB}^{UL} - 6 - n_{PRB\ offset}^{RA} - 6 \left\lfloor \frac{f_{RA}}{2} \right\rfloor, & \text{otherwise} \end{cases}$$

where  $N_{RB}^{UL}$  is the number of uplink resource blocks,  $n_{PRB}^{RA}$  is the first physical resource block allocated to the PRACH opportunity considered and where the parameter *prach-FrequencyOffset*  $n_{PRB\ offset}^{RA}$  is the first physical resource block available for PRACH expressed as a physical resource block number configured by higher layers and fulfilling  $0 \leq n_{PRB\ offset}^{RA} \leq N_{RB}^{UL} - 6$ .

For preamble format 4, the frequency multiplexing shall be done according to

$$n_{PRB}^{RA} = \begin{cases} 6f_{RA}, & \text{if } ((n_f \bmod 2) \times (2 - N_{SP}) + t_{RA}^1) \bmod 2 = 0 \\ N_{RB}^{UL} - 6(f_{RA} + 1), & \text{otherwise} \end{cases}$$

where  $n_f$  is the system frame number and where  $N_{SP}$  is the number of DL to UL switch points within the radio frame.

Each random access preamble occupies a bandwidth corresponding to 6 consecutive resource blocks for both frame structures.

Table 5.7.1-4: Frame structure type 2 random access preamble mapping in time and frequency.

PRACH configuration Index (See Table 5.7.1-3)	UL/DL configuration (See Table 4.2-2)						
	0	1	2	3	4	5	6
0	(0,1,0,2)	(0,1,0,1)	(0,1,0,0)	(0,1,0,2)	(0,1,0,1)	(0,1,0,0)	(0,1,0,2)
1	(0,2,0,2)	(0,2,0,1)	(0,2,0,0)	(0,2,0,2)	(0,2,0,1)	(0,2,0,0)	(0,2,0,2)
2	(0,1,1,2)	(0,1,1,1)	(0,1,1,0)	(0,1,0,1)	(0,1,0,0)	N/A	(0,1,1,1)
3	(0,0,0,2)	(0,0,0,1)	(0,0,0,0)	(0,0,0,2)	(0,0,0,1)	(0,0,0,0)	(0,0,0,2)
4	(0,0,1,2)	(0,0,1,1)	(0,0,1,0)	(0,0,0,1)	(0,0,0,0)	N/A	(0,0,1,1)
5	(0,0,0,1)	(0,0,0,0)	N/A	(0,0,0,0)	N/A	N/A	(0,0,0,1)
6	(0,0,0,2) (0,0,1,2)	(0,0,0,1) (0,0,1,1)	(0,0,0,0) (0,0,1,0)	(0,0,0,1) (0,0,0,2)	(0,0,0,0) (0,0,0,1)	(0,0,0,0) (1,0,0,0)	(0,0,0,2) (0,0,1,1)
7	(0,0,0,1) (0,0,1,1)	(0,0,0,0) (0,0,1,0)	N/A	(0,0,0,0) (0,0,0,2)	N/A	N/A	(0,0,0,1) (0,0,1,0)
8	(0,0,0,0) (0,0,1,0)	N/A	N/A	(0,0,0,0) (0,0,0,1)	N/A	N/A	(0,0,0,0) (0,0,1,1)
9	(0,0,0,1) (0,0,0,2) (0,0,1,2)	(0,0,0,0) (0,0,0,1) (0,0,1,1)	(0,0,0,0) (0,0,1,0) (1,0,0,0)	(0,0,0,0) (0,0,0,1) (0,0,0,2)	(0,0,0,0) (0,0,0,1) (1,0,0,1)	(0,0,0,0) (1,0,0,0) (2,0,0,0)	(0,0,0,1) (0,0,0,2) (0,0,1,1)
10	(0,0,0,0) (0,0,1,0) (0,0,1,1)	(0,0,0,1) (0,0,1,0) (0,0,1,1)	(0,0,0,0) (0,0,1,0) (1,0,1,0)	N/A	(0,0,0,0) (0,0,0,1) (1,0,0,0)	N/A	(0,0,0,0) (0,0,0,2) (0,0,1,0)
11	N/A	(0,0,0,0) (0,0,0,1) (0,0,1,0)	N/A	N/A	N/A	N/A	(0,0,0,1) (0,0,1,0) (0,0,1,1)
12	(0,0,0,1) (0,0,0,2) (0,0,1,1) (0,0,1,2)	(0,0,0,0) (0,0,0,1) (0,0,1,0) (0,0,1,1)	(0,0,0,0) (0,0,1,0) (1,0,0,0) (1,0,1,0)	(0,0,0,0) (0,0,0,1) (0,0,0,2) (1,0,0,1)	(0,0,0,0) (0,0,0,1) (1,0,0,0) (1,0,0,2)	(0,0,0,0) (1,0,0,0) (2,0,0,0) (3,0,0,0)	(0,0,0,1) (0,0,0,2) (0,0,1,0) (0,0,1,1)
13	(0,0,0,0) (0,0,0,2) (0,0,1,0) (0,0,1,2)	N/A	N/A	(0,0,0,0) (0,0,0,1) (0,0,0,2) (1,0,0,1)	N/A	N/A	(0,0,0,0) (0,0,0,1) (0,0,0,2) (0,0,1,1)
14	(0,0,0,0) (0,0,0,1) (0,0,1,0) (0,0,1,1)	N/A	N/A	(0,0,0,0) (0,0,0,1) (0,0,0,2) (1,0,0,0)	N/A	N/A	(0,0,0,0) (0,0,0,2) (0,0,1,0) (0,0,1,1)
15	(0,0,0,0) (0,0,0,1) (0,0,0,2) (0,0,1,1) (0,0,1,2)	(0,0,0,0) (0,0,0,1) (0,0,1,0) (0,0,1,1) (1,0,0,1)	(0,0,0,0) (0,0,1,0) (1,0,0,0) (1,0,1,0) (2,0,0,0)	(0,0,0,0) (0,0,0,1) (0,0,0,2) (1,0,0,1) (1,0,0,2)	(0,0,0,0) (0,0,0,1) (1,0,0,0) (1,0,0,1) (2,0,0,1)	(0,0,0,0) (1,0,0,0) (2,0,0,0) (3,0,0,0) (4,0,0,0)	(0,0,0,0) (0,0,0,1) (0,0,0,2) (0,0,1,0) (0,0,1,1)
16	(0,0,0,1) (0,0,0,2) (0,0,1,0) (0,0,1,1) (0,0,1,2)	(0,0,0,0) (0,0,0,1) (0,0,1,0) (0,0,1,1) (1,0,1,1)	(0,0,0,0) (0,0,1,0) (1,0,0,0) (1,0,1,0) (2,0,1,0)	(0,0,0,0) (0,0,1,0) (0,0,0,2) (1,0,0,0) (1,0,0,2)	(0,0,0,0) (0,0,0,1) (1,0,0,0) (1,0,0,1) (2,0,0,0)	N/A	N/A
17	(0,0,0,0) (0,0,0,1) (0,0,0,2) (0,0,1,0) (0,0,1,2)	(0,0,0,0) (0,0,0,1) (0,0,1,0) (0,0,1,1) (1,0,0,0)	N/A	(0,0,0,0) (0,0,0,1) (0,0,0,2) (1,0,0,0) (1,0,0,1)	N/A	N/A	N/A
18	(0,0,0,0) (0,0,0,1) (0,0,0,2) (0,0,1,0) (0,0,1,1) (0,0,1,2)	(0,0,0,0) (0,0,0,1) (0,0,1,0) (0,0,1,1) (1,0,0,1) (1,0,1,1)	(0,0,0,0) (0,0,1,0) (1,0,0,0) (1,0,1,0) (2,0,0,0) (2,0,1,0)	(0,0,0,0) (0,0,0,1) (0,0,0,2) (1,0,0,0) (1,0,0,2)	(0,0,0,0) (0,0,0,1) (1,0,0,0) (1,0,0,1) (2,0,0,0) (2,0,0,1)	(0,0,0,0) (1,0,0,0) (2,0,0,0) (3,0,0,0) (4,0,0,0) (5,0,0,0)	(0,0,0,0) (0,0,0,1) (0,0,0,2) (0,0,1,0) (0,0,1,1) (1,0,0,2)
19	N/A	(0,0,0,0) (0,0,0,1) (0,0,1,0) (0,0,1,1) (1,0,0,0) (1,0,1,0)	N/A	N/A	N/A	N/A	(0,0,0,0) (0,0,0,1) (0,0,0,2) (0,0,1,0) (0,0,1,1) (1,0,1,1)
20 / 30	(0,1,0,1)	(0,1,0,0)	N/A	(0,1,0,1)	(0,1,0,0)	N/A	(0,1,0,1)
21 / 31	(0,2,0,1)	(0,2,0,0)	N/A	(0,2,0,1)	(0,2,0,0)	N/A	(0,2,0,1)

22 / 32	(0,1,1,1)	(0,1,1,0)	N/A	N/A	N/A	N/A	(0,1,1,0)
23 / 33	(0,0,0,1)	(0,0,0,0)	N/A	(0,0,0,1)	(0,0,0,0)	N/A	(0,0,0,1)
24 / 34	(0,0,1,1)	(0,0,1,0)	N/A	N/A	N/A	N/A	(0,0,1,0)
25 / 35	(0,0,0,1) (0,0,1,1)	(0,0,0,0) (0,0,1,0)	N/A	(0,0,0,1) (1,0,0,1)	(0,0,0,0) (1,0,0,0)	N/A	(0,0,0,1) (0,0,1,0)
26 / 36	(0,0,0,1) (0,0,1,1) (1,0,0,1)	(0,0,0,0) (0,0,1,0) (1,0,0,0)	N/A	(0,0,0,1) (1,0,0,1) (2,0,0,1)	(0,0,0,0) (1,0,0,0) (2,0,0,0)	N/A	(0,0,0,1) (0,0,1,0) (1,0,0,1)
27 / 37	(0,0,0,1) (0,0,1,1) (1,0,0,1) (1,0,1,1)	(0,0,0,0) (0,0,1,0) (1,0,0,0) (1,0,1,0)	N/A	(0,0,0,1) (1,0,0,1) (2,0,0,1) (3,0,0,1)	(0,0,0,0) (1,0,0,0) (2,0,0,0) (3,0,0,0)	N/A	(0,0,0,1) (0,0,1,0) (1,0,0,1) (1,0,1,0)
28 / 38	(0,0,0,1) (0,0,1,1) (1,0,0,1) (1,0,1,1) (2,0,0,1)	(0,0,0,0) (0,0,1,0) (1,0,0,0) (1,0,1,0) (2,0,0,0)	N/A	(0,0,0,1) (1,0,0,1) (2,0,0,1) (3,0,0,1) (4,0,0,1)	(0,0,0,0) (1,0,0,0) (2,0,0,0) (3,0,0,0) (4,0,0,0)	N/A	(0,0,0,1) (0,0,1,0) (1,0,0,1) (1,0,1,0) (2,0,0,1)
29 / 39	(0,0,0,1) (0,0,1,1) (1,0,0,1) (1,0,1,1) (2,0,0,1) (2,0,1,1)	(0,0,0,0) (0,0,1,0) (1,0,0,0) (1,0,1,0) (2,0,0,0) (2,0,1,0)	N/A	(0,0,0,1) (1,0,0,1) (2,0,0,1) (3,0,0,1) (4,0,0,1) (5,0,0,1)	(0,0,0,0) (1,0,0,0) (2,0,0,0) (3,0,0,0) (4,0,0,0) (5,0,0,0)	N/A	(0,0,0,1) (0,0,1,0) (1,0,0,1) (1,0,1,0) (2,0,0,1) (2,0,1,0)
40	(0,1,0,0)	N/A	N/A	(0,1,0,0)	N/A	N/A	(0,1,0,0)
41	(0,2,0,0)	N/A	N/A	(0,2,0,0)	N/A	N/A	(0,2,0,0)
42	(0,1,1,0)	N/A	N/A	N/A	N/A	N/A	N/A
43	(0,0,0,0)	N/A	N/A	(0,0,0,0)	N/A	N/A	(0,0,0,0)
44	(0,0,1,0)	N/A	N/A	N/A	N/A	N/A	N/A
45	(0,0,0,0) (0,0,1,0)	N/A	N/A	(0,0,0,0) (1,0,0,0)	N/A	N/A	(0,0,0,0) (1,0,0,0)
46	(0,0,0,0) (0,0,1,0) (1,0,0,0)	N/A	N/A	(0,0,0,0) (1,0,0,0) (2,0,0,0)	N/A	N/A	(0,0,0,0) (1,0,0,0) (2,0,0,0)
47	(0,0,0,0) (0,0,1,0) (1,0,0,0) (1,0,1,0)	N/A	N/A	(0,0,0,0) (1,0,0,0) (2,0,0,0) (3,0,0,0)	N/A	N/A	(0,0,0,0) (1,0,0,0) (2,0,0,0) (3,0,0,0)
48	(0,1,0,*)	(0,1,0,*)	(0,1,0,*)	(0,1,0,*)	(0,1,0,*)	(0,1,0,*)	(0,1,0,*)
49	(0,2,0,*)	(0,2,0,*)	(0,2,0,*)	(0,2,0,*)	(0,2,0,*)	(0,2,0,*)	(0,2,0,*)
50	(0,1,1,*)	(0,1,1,*)	(0,1,1,*)	N/A	N/A	N/A	(0,1,1,*)
51	(0,0,0,*)	(0,0,0,*)	(0,0,0,*)	(0,0,0,*)	(0,0,0,*)	(0,0,0,*)	(0,0,0,*)
52	(0,0,1,*)	(0,0,1,*)	(0,0,1,*)	N/A	N/A	N/A	(0,0,1,*)
53	(0,0,0,*) (0,0,1,*)	(0,0,0,*) (0,0,1,*)	(0,0,0,*) (0,0,1,*)	(0,0,0,*) (1,0,0,*)	(0,0,0,*) (1,0,0,*)	(0,0,0,*) (1,0,0,*)	(0,0,0,*) (0,0,1,*)
54	(0,0,0,*) (0,0,1,*) (1,0,0,*)	(0,0,0,*) (0,0,1,*) (1,0,0,*)	(0,0,0,*) (0,0,1,*) (1,0,0,*)	(0,0,0,*) (1,0,0,*) (2,0,0,*)	(0,0,0,*) (1,0,0,*) (2,0,0,*)	(0,0,0,*) (1,0,0,*) (2,0,0,*)	(0,0,0,*) (0,0,1,*) (1,0,0,*)
55	(0,0,0,*) (0,0,1,*) (1,0,0,*) (1,0,1,*)	(0,0,0,*) (0,0,1,*) (1,0,0,*) (1,0,1,*)	(0,0,0,*) (0,0,1,*) (1,0,0,*) (1,0,1,*)	(0,0,0,*) (1,0,0,*) (2,0,0,*) (3,0,0,*)	(0,0,0,*) (1,0,0,*) (2,0,0,*) (3,0,0,*)	(0,0,0,*) (1,0,0,*) (2,0,0,*) (3,0,0,*)	(0,0,0,*) (0,0,1,*) (1,0,0,*) (1,0,1,*)
56	(0,0,0,*) (0,0,1,*) (1,0,0,*) (1,0,1,*) (2,0,0,*)	(0,0,0,*) (0,0,1,*) (1,0,0,*) (1,0,1,*) (2,0,0,*)	(0,0,0,*) (0,0,1,*) (1,0,0,*) (1,0,1,*) (2,0,0,*)	(0,0,0,*) (1,0,0,*) (2,0,0,*) (3,0,0,*) (4,0,0,*)	(0,0,0,*) (1,0,0,*) (2,0,0,*) (3,0,0,*) (4,0,0,*)	(0,0,0,*) (1,0,0,*) (2,0,0,*) (3,0,0,*) (4,0,0,*)	(0,0,0,*) (0,0,1,*) (1,0,0,*) (1,0,1,*) (2,0,0,*)
57	(0,0,0,*) (0,0,1,*) (1,0,0,*) (1,0,1,*) (2,0,0,*) (2,0,1,*)	(0,0,0,*) (0,0,1,*) (1,0,0,*) (1,0,1,*) (2,0,0,*) (2,0,1,*)	(0,0,0,*) (0,0,1,*) (1,0,0,*) (1,0,1,*) (2,0,0,*) (2,0,1,*)	(0,0,0,*) (1,0,0,*) (2,0,0,*) (3,0,0,*) (4,0,0,*) (5,0,0,*)	(0,0,0,*) (1,0,0,*) (2,0,0,*) (3,0,0,*) (4,0,0,*) (5,0,0,*)	(0,0,0,*) (1,0,0,*) (2,0,0,*) (3,0,0,*) (4,0,0,*) (5,0,0,*)	(0,0,0,*) (0,0,1,*) (1,0,0,*) (1,0,1,*) (2,0,0,*) (2,0,1,*)
58	N/A	N/A	N/A	N/A	N/A	N/A	N/A
59	N/A	N/A	N/A	N/A	N/A	N/A	N/A
60	N/A	N/A	N/A	N/A	N/A	N/A	N/A
61	N/A	N/A	N/A	N/A	N/A	N/A	N/A
62	N/A	N/A	N/A	N/A	N/A	N/A	N/A

63	N/A	N/A	N/A	N/A	N/A	N/A	N/A
----	-----	-----	-----	-----	-----	-----	-----

\* UpPTS

## 5.7.2 Preamble sequence generation

The random access preambles are generated from Zadoff-Chu sequences with zero correlation zone, generated from one or several root Zadoff-Chu sequences. The network configures the set of preamble sequences the UE is allowed to use.

There are 64 preambles available in each cell. The set of 64 preamble sequences in a cell is found by including first, in the order of increasing cyclic shift, all the available cyclic shifts of a root Zadoff-Chu sequence with the logical index RACH\_ROOT\_SEQUENCE, where RACH\_ROOT\_SEQUENCE is broadcasted as part of the System Information. Additional preamble sequences, in case 64 preambles cannot be generated from a single root Zadoff-Chu sequence, are obtained from the root sequences with the consecutive logical indexes until all the 64 sequences are found. The logical root sequence order is cyclic: the logical index 0 is consecutive to 837. The relation between a logical root sequence index and physical root sequence index  $u$  is given by Tables 5.7.2-4 and 5.7.2-5 for preamble formats 0 – 3 and 4, respectively.

The  $u^{\text{th}}$  root Zadoff-Chu sequence is defined by

$$x_u(n) = e^{-j \frac{2\pi n(n+1)}{N_{ZC}}}, \quad 0 \leq n \leq N_{ZC} - 1$$

where the length  $N_{ZC}$  of the Zadoff-Chu sequence is given by Table 5.7.2-1. From the  $u^{\text{th}}$  root Zadoff-Chu sequence, random access preambles with zero correlation zones of length  $N_{CS} - 1$  are defined by cyclic shifts according to

$$x_{u,v}(n) = x_u((n + C_v) \bmod N_{ZC})$$

where the cyclic shift is given by

$$C_v = \begin{cases} vN_{CS} & v = 0, 1, \dots, \lfloor N_{ZC}/N_{CS} \rfloor - 1, N_{CS} \neq 0 & \text{for unrestricted sets} \\ 0 & N_{CS} = 0 & \text{for unrestricted sets} \\ d_{\text{start}} \lfloor v/n_{\text{shift}}^{\text{RA}} \rfloor + (v \bmod n_{\text{shift}}^{\text{RA}})N_{CS} & v = 0, 1, \dots, n_{\text{shift}}^{\text{RA}} n_{\text{group}}^{\text{RA}} + \bar{n}_{\text{shift}}^{\text{RA}} - 1 & \text{for restricted sets} \end{cases}$$

and  $N_{CS}$  is given by Tables 5.7.2-2 and 5.7.2-3 for preamble formats 0-3 and 4, respectively. The parameter *High-speed-flag* provided by higher layers determines if unrestricted set or restricted set shall be used.

The variable  $d_u$  is the cyclic shift corresponding to a Doppler shift of magnitude  $1/T_{\text{SEQ}}$  and is given by

$$d_u = \begin{cases} p & 0 \leq p < N_{ZC}/2 \\ N_{ZC} - p & \text{otherwise} \end{cases}$$

where  $p$  is the smallest non-negative integer that fulfils  $(pu) \bmod N_{ZC} = 1$ . The parameters for restricted sets of cyclic shifts depend on  $d_u$ . For  $N_{CS} \leq d_u < N_{ZC}/3$ , the parameters are given by

$$\begin{aligned} n_{\text{shift}}^{\text{RA}} &= \lfloor d_u / N_{CS} \rfloor \\ d_{\text{start}} &= 2d_u + n_{\text{shift}}^{\text{RA}} N_{CS} \\ n_{\text{group}}^{\text{RA}} &= \lfloor N_{ZC} / d_{\text{start}} \rfloor \\ \bar{n}_{\text{shift}}^{\text{RA}} &= \max(\lfloor (N_{ZC} - 2d_u - n_{\text{group}}^{\text{RA}} d_{\text{start}}) / N_{CS} \rfloor, 0) \end{aligned}$$

For  $N_{ZC}/3 \leq d_u \leq (N_{ZC} - N_{CS})/2$ , the parameters are given by

$$n_{\text{shift}}^{\text{RA}} = \lfloor (N_{\text{ZC}} - 2d_u) / N_{\text{CS}} \rfloor$$

$$d_{\text{start}} = N_{\text{ZC}} - 2d_u + n_{\text{shift}}^{\text{RA}} N_{\text{CS}}$$

$$n_{\text{group}}^{\text{RA}} = \lfloor d_u / d_{\text{start}} \rfloor$$

$$\bar{n}_{\text{shift}}^{\text{RA}} = \min\left(\max\left(\lfloor (d_u - n_{\text{group}}^{\text{RA}} d_{\text{start}}) / N_{\text{CS}} \rfloor, 0\right), n_{\text{shift}}^{\text{RA}}\right)$$

For all other values of  $d_u$ , there are no cyclic shifts in the restricted set.

**Table 5.7.2-1: Random access preamble sequence length.**

Preamble format	$N_{\text{ZC}}$
0 – 3	839
4	139

**Table 5.7.2-2:  $N_{\text{CS}}$  for preamble generation (preamble formats 0-3).**

$N_{\text{CS}}$ configuration	$N_{\text{CS}}$ value	
	Unrestricted set	Restricted set
0	0	15
1	13	18
2	15	22
3	18	26
4	22	32
5	26	38
6	32	46
7	38	55
8	46	68
9	59	82
10	76	100
11	93	128
12	119	158
13	167	202
14	279	237
15	419	-

**Table 5.7.2-3:  $N_{CS}$  for preamble generation (preamble format 4).**

$N_{CS}$ configuration	$N_{CS}$ value
0	2
1	4
2	6
3	8
4	10
5	12
6	15
7	N/A
8	N/A
9	N/A
10	N/A
11	N/A
12	N/A
13	N/A
14	N/A
15	N/A

Table 5.7.2-4: Root Zadoff-Chu sequence order for preamble formats 0 – 3.

Logical root sequence number	Physical root sequence number $u$ (in increasing order of the corresponding logical sequence number)
0–23	129, 710, 140, 699, 120, 719, 210, 629, 168, 671, 84, 755, 105, 734, 93, 746, 70, 769, 60, 779, 2, 837, 1, 838
24–29	56, 783, 112, 727, 148, 691
30–35	80, 759, 42, 797, 40, 799
36–41	35, 804, 73, 766, 146, 693
42–51	31, 808, 28, 811, 30, 809, 27, 812, 29, 810
52–63	24, 815, 48, 791, 68, 771, 74, 765, 178, 661, 136, 703
64–75	86, 753, 78, 761, 43, 796, 39, 800, 20, 819, 21, 818
76–89	95, 744, 202, 637, 190, 649, 181, 658, 137, 702, 125, 714, 151, 688
90–115	217, 622, 128, 711, 142, 697, 122, 717, 203, 636, 118, 721, 110, 729, 89, 750, 103, 736, 61, 778, 55, 784, 15, 824, 14, 825
116–135	12, 827, 23, 816, 34, 805, 37, 802, 46, 793, 207, 632, 179, 660, 145, 694, 130, 709, 223, 616
136–167	228, 611, 227, 612, 132, 707, 133, 706, 143, 696, 135, 704, 161, 678, 201, 638, 173, 666, 106, 733, 83, 756, 91, 748, 66, 773, 53, 786, 10, 829, 9, 830
168–203	7, 832, 8, 831, 16, 823, 47, 792, 64, 775, 57, 782, 104, 735, 101, 738, 108, 731, 208, 631, 184, 655, 197, 642, 191, 648, 121, 718, 141, 698, 149, 690, 216, 623, 218, 621
204–263	152, 687, 144, 695, 134, 705, 138, 701, 199, 640, 162, 677, 176, 663, 119, 720, 158, 681, 164, 675, 174, 665, 171, 668, 170, 669, 87, 752, 169, 670, 88, 751, 107, 732, 81, 758, 82, 757, 100, 739, 98, 741, 71, 768, 59, 780, 65, 774, 50, 789, 49, 790, 26, 813, 17, 822, 13, 826, 6, 833
264–327	5, 834, 33, 806, 51, 788, 75, 764, 99, 740, 96, 743, 97, 742, 166, 673, 172, 667, 175, 664, 187, 652, 163, 676, 185, 654, 200, 639, 114, 725, 189, 650, 115, 724, 194, 645, 195, 644, 192, 647, 182, 657, 157, 682, 156, 683, 211, 628, 154, 685, 123, 716, 139, 700, 212, 627, 153, 686, 213, 626, 215, 624, 150, 689
328–383	225, 614, 224, 615, 221, 618, 220, 619, 127, 712, 147, 692, 124, 715, 193, 646, 205, 634, 206, 633, 116, 723, 160, 679, 186, 653, 167, 672, 79, 760, 85, 754, 77, 762, 92, 747, 58, 781, 62, 777, 69, 770, 54, 785, 36, 803, 32, 807, 25, 814, 18, 821, 11, 828, 4, 835
384–455	3, 836, 19, 820, 22, 817, 41, 798, 38, 801, 44, 795, 52, 787, 45, 794, 63, 776, 67, 772, 72, 767, 76, 763, 94, 745, 102, 737, 90, 749, 109, 730, 165, 674, 111, 728, 209, 630, 204, 635, 117, 722, 188, 651, 159, 680, 198, 641, 113, 726, 183, 656, 180, 659, 177, 662, 196, 643, 155, 684, 214, 625, 126, 713, 131, 708, 219, 620, 222, 617, 226, 613
456–513	230, 609, 232, 607, 262, 577, 252, 587, 418, 421, 416, 423, 413, 426, 411, 428, 376, 463, 395, 444, 283, 556, 285, 554, 379, 460, 390, 449, 363, 476, 384, 455, 388, 451, 386, 453, 361, 478, 387, 452, 360, 479, 310, 529, 354, 485, 328, 511, 315, 524, 337, 502, 349, 490, 335, 504, 324, 515
514–561	323, 516, 320, 519, 334, 505, 359, 480, 295, 544, 385, 454, 292, 547, 291, 548, 381, 458, 399, 440, 380, 459, 397, 442, 369, 470, 377, 462, 410, 429, 407, 432, 281, 558, 414, 425, 247, 592, 277, 562, 271, 568, 272, 567, 264, 575, 259, 580
562–629	237, 602, 239, 600, 244, 595, 243, 596, 275, 564, 278, 561, 250, 589, 246, 593, 417, 422, 248, 591, 394, 445, 393, 446, 370, 469, 365, 474, 300, 539, 299, 540, 364, 475, 362, 477, 298, 541, 312, 527, 313, 526, 314, 525, 353, 486, 352, 487, 343, 496, 327, 512, 350, 489, 326, 513, 319, 520, 332, 507, 333, 506, 348, 491, 347, 492, 322, 517
630–659	330, 509, 338, 501, 341, 498, 340, 499, 342, 497, 301, 538, 366, 473, 401, 438, 371, 468, 408, 431, 375, 464, 249, 590, 269, 570, 238, 601, 234, 605
660–707	257, 582, 273, 566, 255, 584, 254, 585, 245, 594, 251, 588, 412, 427, 372, 467, 282, 557, 403, 436, 396, 443, 392, 447, 391, 448, 382, 457, 389, 450, 294, 545, 297, 542, 311, 528, 344, 495, 345, 494, 318, 521, 331, 508, 325, 514, 321, 518
708–729	346, 493, 339, 500, 351, 488, 306, 533, 289, 550, 400, 439, 378, 461, 374, 465, 415, 424, 270, 569, 241, 598
730–751	231, 608, 260, 579, 268, 571, 276, 563, 409, 430, 398, 441, 290, 549, 304, 535, 308, 531, 358, 481, 316, 523
752–765	293, 546, 288, 551, 284, 555, 368, 471, 253, 586, 256, 583, 263, 576
766–777	242, 597, 274, 565, 402, 437, 383, 456, 357, 482, 329, 510
778–789	317, 522, 307, 532, 286, 553, 287, 552, 266, 573, 261, 578
790–795	236, 603, 303, 536, 356, 483
796–803	355, 484, 405, 434, 404, 435, 406, 433
804–809	235, 604, 267, 572, 302, 537
810–815	309, 530, 265, 574, 233, 606
816–819	367, 472, 296, 543
820–837	336, 503, 305, 534, 373, 466, 280, 559, 279, 560, 419, 420, 240, 599, 258, 581, 229, 610

Table 5.7.2-5: Root Zadoff-Chu sequence order for preamble format 4.

Logical root sequence number	Physical root sequence number $u$ (in increasing order of the corresponding logical sequence number)																			
	0 – 19	1	138	2	137	3	136	4	135	5	134	6	133	7	132	8	131	9	130	10
20 – 39	11	128	12	127	13	126	14	125	15	124	16	123	17	122	18	121	19	120	20	119
40 – 59	21	118	22	117	23	116	24	115	25	114	26	113	27	112	28	111	29	110	30	109
60 – 79	31	108	32	107	33	106	34	105	35	104	36	103	37	102	38	101	39	100	40	99
80 – 99	41	98	42	97	43	96	44	95	45	94	46	93	47	92	48	91	49	90	50	89
100 – 119	51	88	52	87	53	86	54	85	55	84	56	83	57	82	58	81	59	80	60	79
120 – 137	61	78	62	77	63	76	64	75	65	74	66	73	67	72	68	71	69	70	-	-
138 – 837	N/A																			

### 5.7.3 Baseband signal generation

The time-continuous random access signal  $s(t)$  is defined by

$$s(t) = \beta_{\text{PRACH}} \sum_{k=0}^{N_{\text{ZC}}-1} \sum_{n=0}^{N_{\text{ZC}}-1} x_{u,v}(n) \cdot e^{-j \frac{2\pi nk}{N_{\text{ZC}}}} \cdot e^{j 2\pi (k + \varphi + K(k_0 + \frac{1}{2})) \Delta f_{\text{RA}} (t - T_{\text{CP}})}$$

where  $0 \leq t < T_{\text{SEQ}} + T_{\text{CP}}$ ,  $\beta_{\text{PRACH}}$  is an amplitude scaling factor in order to conform to the transmit power  $P_{\text{PRACH}}$  specified in Section 6.1 in [4], and **Error! Objects cannot be created from editing field codes.** The location in the frequency domain is controlled by the parameter  $n_{\text{PRB}}^{\text{RA}}$  is derived from section 5.7.1. The factor  $K = \Delta f / \Delta f_{\text{RA}}$  accounts for the difference in subcarrier spacing between the random access preamble and uplink data transmission. The variable  $\Delta f_{\text{RA}}$ , the subcarrier spacing for the random access preamble, and the variable  $\varphi$ , a fixed offset determining the frequency-domain location of the random access preamble within the physical resource blocks, are both given by Table 5.7.3-1.

Table 5.7.3-1: Random access baseband parameters.

Preamble format	$\Delta f_{\text{RA}}$	$\varphi$
0 – 3	1250 Hz	7
4	7500 Hz	2

### 5.8 Modulation and upconversion

Modulation and upconversion to the carrier frequency of the complex-valued SC-FDMA baseband signal for each antenna port is shown in Figure 5.8-1. The filtering required prior to transmission is defined by the requirements in [7].

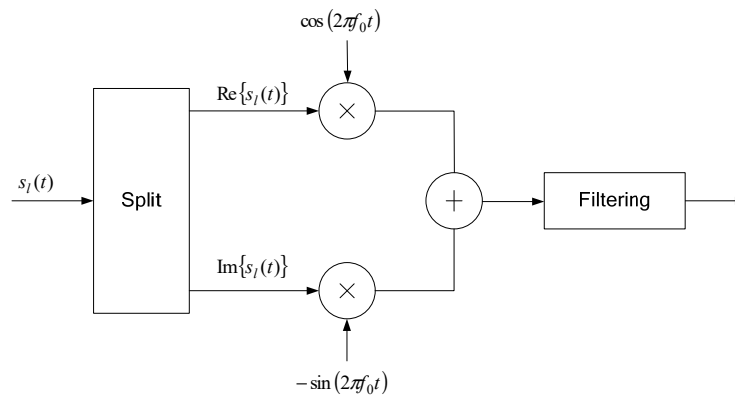

Figure 5.8-1: Uplink modulation.

## 6 Downlink

### 6.1 Overview

The smallest time-frequency unit for downlink transmission is denoted a resource element and is defined in Section 6.2.2.

#### 6.1.1 Physical channels

A downlink physical channel corresponds to a set of resource elements carrying information originating from higher layers and is the interface defined between 36.212 and 36.211. The following downlink physical channels are defined:

- Physical Downlink Shared Channel, PDSCH
- Physical Broadcast Channel, PBCH
- Physical Multicast Channel, PMCH
- Physical Control Format Indicator Channel, PCFICH
- Physical Downlink Control Channel, PDCCH
- Physical Hybrid ARQ Indicator Channel, PHICH

#### 6.1.2 Physical signals

A downlink signal corresponds to a set of resource elements used by the physical layer but does not carry information originating from higher layers. The following downlink physical signals are defined:

- Reference signal
- Synchronization signal

## 6.2 Slot structure and physical resource elements

### 6.2.1 Resource grid

The transmitted signal in each slot is described by a resource grid of  $N_{\text{RB}}^{\text{DL}} N_{\text{sc}}^{\text{RB}}$  subcarriers and  $N_{\text{symb}}^{\text{DL}}$  OFDM symbols. The resource grid structure is illustrated in Figure 6.2.2-1. The quantity  $N_{\text{RB}}^{\text{DL}}$  depends on the downlink transmission bandwidth configured in the cell and shall fulfil

$$N_{\text{RB}}^{\text{min,DL}} \leq N_{\text{RB}}^{\text{DL}} \leq N_{\text{RB}}^{\text{max,DL}}$$

where  $N_{\text{RB}}^{\text{min,DL}} = 6$  and  $N_{\text{RB}}^{\text{max,DL}} = 110$  are the smallest and largest downlink bandwidth, respectively, supported by the current version of this specification.

The set of allowed values for  $N_{\text{RB}}^{\text{DL}}$  is given by [6]. The number of OFDM symbols in a slot depends on the cyclic prefix length and subcarrier spacing configured and is given in Table 6.2.3-1.

In case of multi-antenna transmission, there is one resource grid defined per antenna port. An antenna port is defined by its associated reference signal. The set of antenna ports supported depends on the reference signal configuration in the cell:

- Cell-specific reference signals, associated with non-MBSFN transmission, support a configuration of one, two, or four antenna ports and the antenna port number  $p$  shall fulfil  $p = 0$ ,  $p \in \{0,1\}$ , and  $p \in \{0,1,2,3\}$ , respectively.
- MBSFN reference signals, associated with MBSFN transmission, are transmitted on antenna port  $p = 4$ .
- UE-specific reference signals are transmitted on antenna port  $p = 5$ .

### 6.2.2 Resource elements

Each element in the resource grid for antenna port  $p$  is called a resource element and is uniquely identified by the index pair  $(k, l)$  in a slot where  $k = 0, \dots, N_{\text{RB}}^{\text{DL}} N_{\text{sc}}^{\text{RB}} - 1$  and  $l = 0, \dots, N_{\text{symb}}^{\text{DL}} - 1$  are the indices in the frequency and time domains, respectively. Resource element  $(k, l)$  on antenna port  $p$  corresponds to the complex value  $a_{k,l}^{(p)}$ . When there is no risk for confusion, or no particular antenna port is specified, the index  $p$  may be dropped.

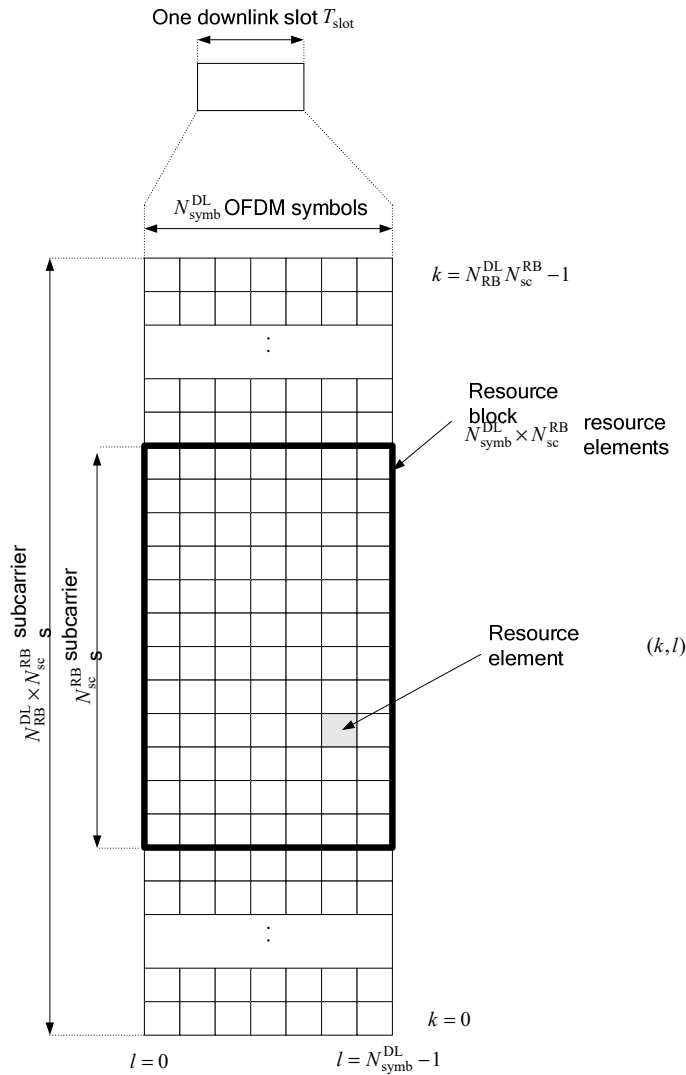

Figure 6.2.2-1: Downlink resource grid.

### 6.2.3 Resource blocks

Resource blocks are used to describe the mapping of certain physical channels to resource elements. Physical and virtual resource blocks are defined.

A physical resource block is defined as  $N_{\text{symb}}^{\text{DL}}$  consecutive OFDM symbols in the time domain and  $N_{\text{sc}}^{\text{RB}}$  consecutive subcarriers in the frequency domain, where  $N_{\text{symb}}^{\text{DL}}$  and  $N_{\text{sc}}^{\text{RB}}$  are given by Table 6.2.3-1. A physical resource block thus consists of  $N_{\text{symb}}^{\text{DL}} \times N_{\text{sc}}^{\text{RB}}$  resource elements, corresponding to one slot in the time domain and 180 kHz in the frequency domain.

Physical resource blocks are numbered from 0 to  $N_{\text{RB}}^{\text{DL}} - 1$  in the frequency domain. The relation between the physical resource block number  $n_{\text{PRB}}$  in the frequency domain and resource elements  $(k, l)$  in a slot is given by

$$n_{\text{PRB}} = \left\lfloor \frac{k}{N_{\text{sc}}^{\text{RB}}} \right\rfloor$$

**Table 6.2.3-1: Physical resource blocks parameters.**

Configuration		$N_{sc}^{RB}$	$N_{symb}^{DL}$
Normal cyclic prefix	$\Delta f = 15$ kHz	12	7
	$\Delta f = 7.5$ kHz		6
Extended cyclic prefix	$\Delta f = 7.5$ kHz	24	3

A virtual resource block is of the same size as a physical resource block. Two types of virtual resource blocks are defined:

- Virtual resource blocks of localized type
- Virtual resource blocks of distributed type

For each type of virtual resource blocks, a pair of virtual resource blocks over two slots in a subframe is assigned together by a single virtual resource block number,  $n_{VRB}$ .

### 6.2.3.1 Virtual resource blocks of localized type

Virtual resource blocks of localized type are mapped directly to physical resource blocks such that virtual resource block  $n_{VRB}$  corresponds to physical resource block  $n_{PRB} = n_{VRB}$ . Virtual resource blocks are numbered from 0 to  $N_{VRB}^{DL} - 1$ , where  $N_{VRB}^{DL} = N_{RB}^{DL}$ .

### 6.2.3.2 Virtual resource blocks of distributed type

Virtual resource blocks of distributed type are mapped to physical resource blocks as described below.

**Table 6.2.3.2-1: RB gap values**

System BW ( $N_{RB}^{DL}$ )	Gap ( $N_{gap}$ )	
	1st Gap ( $N_{gap,1}$ )	2nd Gap ( $N_{gap,2}$ )
<b>6-10</b>	$\lceil N_{RB}^{DL} / 2 \rceil$	<b>N/A</b>
<b>11</b>	<b>4</b>	<b>N/A</b>
<b>12-19</b>	<b>8</b>	<b>N/A</b>
<b>20-26</b>	<b>12</b>	<b>N/A</b>
<b>27-44</b>	<b>18</b>	<b>N/A</b>
<b>45-49</b>	<b>27</b>	<b>N/A</b>
<b>50-63</b>	<b>27</b>	<b>9</b>
<b>64-79</b>	<b>32</b>	<b>16</b>
<b>80-110</b>	<b>48</b>	<b>16</b>

The parameter  $N_{gap}$  is given by Table 6.2.3.2-1. For  $6 \leq N_{RB}^{DL} \leq 49$ , only one gap value  $N_{gap,1}$  is defined and  $N_{gap} = N_{gap,1}$ . For  $50 \leq N_{RB}^{DL} \leq 110$ , two gap values  $N_{gap,1}$  and  $N_{gap,2}$  are defined. Whether  $N_{gap} = N_{gap,1}$  or  $N_{gap} = N_{gap,2}$  is signaled as part of the downlink scheduling assignment as described in [3].

Virtual resource blocks of distributed type are numbered from 0 to  $N_{VRB}^{DL} - 1$ , where

$$N_{VRB}^{DL} = N_{VRB,gap1}^{DL} = 2 \cdot \min(N_{gap}, N_{RB}^{DL} - N_{gap}) \text{ for } N_{gap} = N_{gap,1} \text{ and } N_{VRB}^{DL} = N_{VRB,gap2}^{DL} = \lfloor N_{RB}^{DL} / 2N_{gap} \rfloor \cdot 2N_{gap} \text{ for } N_{gap} = N_{gap,2}.$$

Consecutive  $\tilde{N}_{VRB}^{DL}$  VRB numbers compose a unit of VRB number interleaving, where  $\tilde{N}_{VRB}^{DL} = N_{VRB}^{DL}$  for  $N_{gap} = N_{gap,1}$  and  $\tilde{N}_{VRB}^{DL} = 2N_{gap}$  for  $N_{gap} = N_{gap,2}$ . Interleaving of VRB numbers of each interleaving unit is performed with 4

columns and  $N_{\text{row}}$  rows, where  $N_{\text{row}} = \lceil \tilde{N}_{\text{VRB}}^{\text{DL}} / (4P) \rceil \cdot P$ , and  $P$  is RBG size as described in [4]. VRB numbers are written row by row in the rectangular matrix, and read out column by column.  $N_{\text{null}}$  nulls are inserted in the last  $N_{\text{null}} / 2$  rows of the 2<sup>nd</sup> and 4<sup>th</sup> column, where  $N_{\text{null}} = 4N_{\text{row}} - \tilde{N}_{\text{VRB}}^{\text{DL}}$ . Nulls are ignored when reading out. The VRB numbers mapping to PRB numbers including interleaving is derived as follows:

For even slot number  $n_s$  ;

$$\tilde{n}_{\text{PRB}}(n_s) = \begin{cases} \tilde{n}'_{\text{PRB}} - N_{\text{row}} & , N_{\text{null}} \neq 0 \text{ and } \tilde{n}_{\text{VRB}} \geq \tilde{N}_{\text{VRB}}^{\text{DL}} - N_{\text{null}} \text{ and } \tilde{n}_{\text{VRB}} \bmod 2 = 1 \\ \tilde{n}'_{\text{PRB}} - N_{\text{row}} + N_{\text{null}} / 2 & , N_{\text{null}} \neq 0 \text{ and } \tilde{n}_{\text{VRB}} \geq \tilde{N}_{\text{VRB}}^{\text{DL}} - N_{\text{null}} \text{ and } \tilde{n}_{\text{VRB}} \bmod 2 = 0 \\ \tilde{n}''_{\text{PRB}} - N_{\text{null}} / 2 & , N_{\text{null}} \neq 0 \text{ and } \tilde{n}_{\text{VRB}} < \tilde{N}_{\text{VRB}}^{\text{DL}} - N_{\text{null}} \text{ and } \tilde{n}_{\text{VRB}} \bmod 4 \geq 2 \\ \tilde{n}''_{\text{PRB}} & , \text{otherwise} \end{cases}$$

where  $\tilde{n}'_{\text{PRB}} = 2N_{\text{row}} \cdot (\tilde{n}_{\text{VRB}} \bmod 2) + \lfloor \tilde{n}_{\text{VRB}} / 2 \rfloor + \tilde{N}_{\text{VRB}}^{\text{DL}} \cdot \lfloor n_{\text{VRB}} / \tilde{N}_{\text{VRB}}^{\text{DL}} \rfloor$ ,  
and  $\tilde{n}''_{\text{PRB}} = N_{\text{row}} \cdot (\tilde{n}_{\text{VRB}} \bmod 4) + \lfloor \tilde{n}_{\text{VRB}} / 4 \rfloor + \tilde{N}_{\text{VRB}}^{\text{DL}} \cdot \lfloor n_{\text{VRB}} / \tilde{N}_{\text{VRB}}^{\text{DL}} \rfloor$ ,

where  $\tilde{n}_{\text{VRB}} = n_{\text{VRB}} \bmod \tilde{N}_{\text{VRB}}^{\text{DL}}$  and  $n_{\text{VRB}}$  is obtained from the downlink scheduling assignment as described in [4].

For odd slot number  $n_s$  ;

$$\tilde{n}_{\text{PRB}}(n_s) = (\tilde{n}_{\text{PRB}}(n_s - 1) + \tilde{N}_{\text{VRB}}^{\text{DL}} / 2) \bmod \tilde{N}_{\text{VRB}}^{\text{DL}} + \tilde{N}_{\text{VRB}}^{\text{DL}} \cdot \lfloor n_{\text{VRB}} / \tilde{N}_{\text{VRB}}^{\text{DL}} \rfloor$$

Then, for all  $n_s$  ;

$$n_{\text{PRB}}(n_s) = \begin{cases} \tilde{n}_{\text{PRB}}(n_s) & , \tilde{n}_{\text{PRB}}(n_s) < \tilde{N}_{\text{VRB}}^{\text{DL}} / 2 \\ \tilde{n}_{\text{PRB}}(n_s) + N_{\text{gap}} - \tilde{N}_{\text{VRB}}^{\text{DL}} / 2 & , \tilde{n}_{\text{PRB}}(n_s) \geq \tilde{N}_{\text{VRB}}^{\text{DL}} / 2 \end{cases}$$

## 6.2.4 Resource-element groups

Resource-element groups are used for defining the mapping of control channels to resource elements.

A resource-element group is represented by the index pair  $(k', l')$  of the resource element with the lowest index  $k$  in the group with all resource elements in the group having the same value of  $l$ . The set of resource elements  $(k, l)$  in a resource-element group depends on the number of cell-specific reference signals configured as described below with  $k_0 = n_{\text{PRB}} \cdot N_{\text{sc}}^{\text{RB}}$ ,  $0 \leq n_{\text{PRB}} < N_{\text{RB}}^{\text{DL}}$ .

- In the first OFDM symbol of the first slot in a subframe the two resource-element groups in physical resource block  $n_{\text{PRB}}$  consist of resource elements  $(k, l = 0)$  with  $k = k_0 + 0, k_0 + 1, \dots, k_0 + 5$  and  $k = k_0 + 6, k_0 + 7, \dots, k_0 + 11$ , respectively.
- In the second OFDM symbol of the first slot in a subframe in case of one or two cell-specific reference signals configured, the three resource-element groups in physical resource block  $n_{\text{PRB}}$  consist of resource elements  $(k, l = 1)$  with  $k = k_0 + 0, k_0 + 1, \dots, k_0 + 3$ ,  $k = k_0 + 4, k_0 + 5, \dots, k_0 + 7$  and  $k = k_0 + 8, k_0 + 9, \dots, k_0 + 11$ , respectively.
- In the second OFDM symbol of the first slot in a subframe in case of four cell-specific reference signals configured, the two resource-element groups in physical resource block  $n_{\text{PRB}}$  consist of resource elements  $(k, l = 1)$  with  $k = k_0 + 0, k_0 + 1, \dots, k_0 + 5$  and  $k = k_0 + 6, k_0 + 7, \dots, k_0 + 11$ , respectively.

- In the third OFDM symbol of the first slot in a subframe, the three resource-element groups in physical resource block  $n_{\text{PRB}}$  consist of resource elements  $(k, l = 2)$  with  $k = k_0 + 0, k_0 + 1, \dots, k_0 + 3$ ,  $k = k_0 + 4, k_0 + 5, \dots, k_0 + 7$  and  $k = k_0 + 8, k_0 + 9, \dots, k_0 + 11$ , respectively.
- In the fourth OFDM symbol of the first slot in a subframe in case of normal cyclic prefix, the three resource-element groups in physical resource block  $n_{\text{PRB}}$  consist of resource elements  $(k, l = 3)$  with  $k = k_0 + 0, k_0 + 1, \dots, k_0 + 3$ ,  $k = k_0 + 4, k_0 + 5, \dots, k_0 + 7$  and  $k = k_0 + 8, k_0 + 9, \dots, k_0 + 11$ , respectively.
- In the fourth OFDM symbol of the first slot in a subframe in case of extended cyclic prefix, the two resource-element groups in physical resource block  $n_{\text{PRB}}$  consist of resource elements  $(k, l = 3)$  with  $k = k_0 + 0, k_0 + 1, \dots, k_0 + 5$  and  $k = k_0 + 6, k_0 + 7, \dots, k_0 + 11$ , respectively.

Mapping of a symbol-quadruplet  $\langle z(i), z(i+1), z(i+2), z(i+3) \rangle$  onto a resource-element group represented by resource-element  $(k', l')$  is defined such that elements  $z(i)$  are mapped to resource elements  $(k, l)$  of the resource-element group not used for cell-specific reference signals in increasing order of  $i$  and  $k$ . In case a single cell-specific reference signal is configured, cell-specific reference signals shall be assumed to be present on antenna ports 0 and 1 for the purpose of mapping a symbol-quadruplet to a resource-element group, otherwise the number of cell-specific reference signals shall be assumed equal to the actual number of antenna ports used for cell-specific reference signals. The UE shall not make any assumptions about resource elements assumed to be reserved for reference signals but not used for transmission of a reference signal.

## 6.2.5 Guard period for half-duplex FDD operation

For half-duplex FDD operation, a guard period is created by the UE by not receiving the last part of a downlink subframe immediately preceding an uplink subframe from the same UE.

## 6.2.6 Guard Period for TDD Operation

For frame structure type 2, the GP field in Figure 4.2-1 serves as a guard period.

## 6.3 General structure for downlink physical channels

This section describes a general structure, applicable to more than one physical channel.

The baseband signal representing a downlink physical channel is defined in terms of the following steps:

- scrambling of coded bits in each of the code words to be transmitted on a physical channel
- modulation of scrambled bits to generate complex-valued modulation symbols
- mapping of the complex-valued modulation symbols onto one or several transmission layers
- precoding of the complex-valued modulation symbols on each layer for transmission on the antenna ports
- mapping of complex-valued modulation symbols for each antenna port to resource elements
- generation of complex-valued time-domain OFDM signal for each antenna port

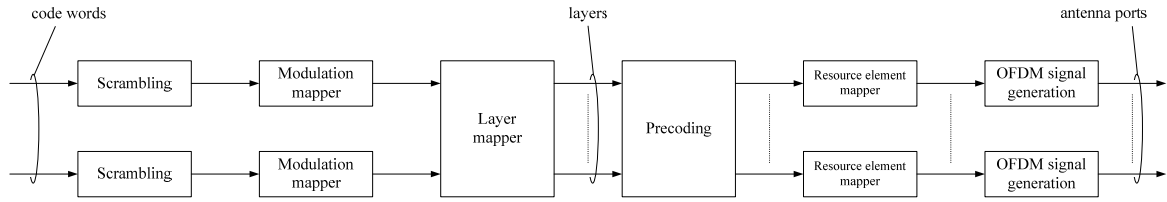

Figure 6.3-1: Overview of physical channel processing.

### 6.3.1 Scrambling

For each code word  $q$ , the block of bits  $b^{(q)}(0), \dots, b^{(q)}(M_{\text{bit}}^{(q)} - 1)$ , where  $M_{\text{bit}}^{(q)}$  is the number of bits in code word  $q$  transmitted on the physical channel in one subframe, shall be scrambled prior to modulation, resulting in a block of scrambled bits  $\tilde{b}^{(q)}(0), \dots, \tilde{b}^{(q)}(M_{\text{bit}}^{(q)} - 1)$  according to

$$\tilde{b}^{(q)}(i) = (b^{(q)}(i) + c^q(i)) \bmod 2$$

where the scrambling sequence  $c^q(i)$  is given by Section 7.2. The scrambling sequence generator shall be initialised at the start of each subframe, where the initialisation value of  $c_{\text{init}}$  depends on the transport channel type according to

$$c_{\text{init}} = \begin{cases} n_{\text{RNTI}} \cdot 2^{14} + q \cdot 2^{13} + \lfloor n_s/2 \rfloor \cdot 2^9 + N_{\text{ID}}^{\text{cell}} & \text{for PDSCH} \\ \lfloor n_s/2 \rfloor \cdot 2^9 + N_{\text{ID}}^{\text{MBSFN}} & \text{for PMCH} \end{cases}$$

where  $n_{\text{RNTI}}$  corresponds to the RNTI associated with the PDSCH transmission as described in Section 7.1[4].

Up to two code words can be transmitted in one subframe, i.e.,  $q \in \{0,1\}$ . In the case of single code word transmission,  $q$  is equal to zero.

### 6.3.2 Modulation

For each code word  $q$ , the block of scrambled bits  $\tilde{b}^{(q)}(0), \dots, \tilde{b}^{(q)}(M_{\text{bit}}^{(q)} - 1)$  shall be modulated as described in Section 7.1 using one of the modulation schemes in Table 6.3.2-1, resulting in a block of complex-valued modulation symbols  $d^{(q)}(0), \dots, d^{(q)}(M_{\text{symp}}^{(q)} - 1)$ .

Table 6.3.2-1: Modulation schemes

Physical channel	Modulation schemes
PDSCH	QPSK, 16QAM, 64QAM
PMCH	QPSK, 16QAM, 64QAM

### 6.3.3 Layer mapping

The complex-valued modulation symbols for each of the code words to be transmitted are mapped onto one or several layers. Complex-valued modulation symbols  $d^{(q)}(0), \dots, d^{(q)}(M_{\text{symp}}^{(q)} - 1)$  for code word  $q$  shall be mapped onto the layers  $x(i) = [x^{(0)}(i) \ \dots \ x^{(v-1)}(i)]^T$ ,  $i = 0, 1, \dots, M_{\text{symp}}^{\text{layer}} - 1$  where  $v$  is the number of layers and  $M_{\text{symp}}^{\text{layer}}$  is the number of modulation symbols per layer.

#### 6.3.3.1 Layer mapping for transmission on a single antenna port

For transmission on a single antenna port, a single layer is used,  $v = 1$ , and the mapping is defined by

$$x^{(0)}(i) = d^{(0)}(i)$$

with  $M_{\text{sy mb}}^{\text{layer}} = M_{\text{sy mb}}^{(0)}$ .

### 6.3.3.2 Layer mapping for spatial multiplexing

For spatial multiplexing, the layer mapping shall be done according to Table 6.3.3.2-1. The number of layers  $v$  is less than or equal to the number of antenna ports  $P$  used for transmission of the physical channel. The case of a single codeword mapped to two layers is only applicable when the number of antenna ports is 4.

**Table 6.3.3.2-1: Codeword-to-layer mapping for spatial multiplexing**

Number of layers	Number of code words	Codeword-to-layer mapping $i = 0, 1, \dots, M_{\text{sy mb}}^{\text{layer}} - 1$
1	1	$x^{(0)}(i) = d^{(0)}(i)$ $M_{\text{sy mb}}^{\text{layer}} = M_{\text{sy mb}}^{(0)}$
2	2	$x^{(0)}(i) = d^{(0)}(i)$ $x^{(1)}(i) = d^{(1)}(i)$ $M_{\text{sy mb}}^{\text{layer}} = M_{\text{sy mb}}^{(0)} = M_{\text{sy mb}}^{(1)}$
2	1	$x^{(0)}(i) = d^{(0)}(2i)$ $x^{(1)}(i) = d^{(0)}(2i+1)$ $M_{\text{sy mb}}^{\text{layer}} = M_{\text{sy mb}}^{(0)} / 2$
3	2	$x^{(0)}(i) = d^{(0)}(i)$ $x^{(1)}(i) = d^{(1)}(2i)$ $x^{(2)}(i) = d^{(1)}(2i+1)$ $M_{\text{sy mb}}^{\text{layer}} = M_{\text{sy mb}}^{(0)} = M_{\text{sy mb}}^{(1)} / 2$
4	2	$x^{(0)}(i) = d^{(0)}(2i)$ $x^{(1)}(i) = d^{(0)}(2i+1)$ $x^{(2)}(i) = d^{(1)}(2i)$ $x^{(3)}(i) = d^{(1)}(2i+1)$ $M_{\text{sy mb}}^{\text{layer}} = M_{\text{sy mb}}^{(0)} / 2 = M_{\text{sy mb}}^{(1)} / 2$

### 6.3.3.3 Layer mapping for transmit diversity

For transmit diversity, the layer mapping shall be done according to Table 6.3.3.3-1. There is only one codeword and the number of layers  $v$  is equal to the number of antenna ports  $P$  used for transmission of the physical channel.

**Table 6.3.3.3-1: Codeword-to-layer mapping for transmit diversity**

Number of layers	Number of code words	Codeword-to-layer mapping $i = 0, 1, \dots, M_{\text{sy mb}}^{\text{layer}} - 1$
2	1	$x^{(0)}(i) = d^{(0)}(2i)$ $x^{(1)}(i) = d^{(0)}(2i+1)$ $M_{\text{sy mb}}^{\text{layer}} = M_{\text{sy mb}}^{(0)} / 2$
4	1	$x^{(0)}(i) = d^{(0)}(4i)$ $x^{(1)}(i) = d^{(0)}(4i+1)$ $x^{(2)}(i) = d^{(0)}(4i+2)$ $x^{(3)}(i) = d^{(0)}(4i+3)$ If $M_{\text{sy mb}}^{(0)} \bmod 4 \neq 0$ two null symbols shall be appended to $d^{(0)}(M_{\text{sy mb}}^{(0)} - 1)$ $M_{\text{sy mb}}^{\text{layer}} = \begin{cases} M_{\text{sy mb}}^{(0)} / 4 & \text{if } M_{\text{sy mb}}^{(0)} \bmod 4 = 0 \\ (M_{\text{sy mb}}^{(0)} + 2) / 4 & \text{if } M_{\text{sy mb}}^{(0)} \bmod 4 \neq 0 \end{cases}$

## 6.3.4 Precoding

The precoder takes as input a block of vectors  $x(i) = [x^{(0)}(i) \dots x^{(\nu-1)}(i)]^T$ ,  $i = 0, 1, \dots, M_{\text{symb}}^{\text{layer}} - 1$  from the layer mapping and generates a block of vectors  $y(i) = [\dots y^{(p)}(i) \dots]^T$ ,  $i = 0, 1, \dots, M_{\text{symb}}^{\text{ap}} - 1$  to be mapped onto resources on each of the antenna ports, where  $y^{(p)}(i)$  represents the signal for antenna port  $p$ .

### 6.3.4.1 Precoding for transmission on a single antenna port

For transmission on a single antenna port, precoding is defined by

$$y^{(p)}(i) = x^{(0)}(i)$$

where  $p \in \{0, 4, 5\}$  is the number of the single antenna port used for transmission of the physical channel and  $i = 0, 1, \dots, M_{\text{symb}}^{\text{ap}} - 1$ ,  $M_{\text{symb}}^{\text{ap}} = M_{\text{symb}}^{\text{layer}}$ .

### 6.3.4.2 Precoding for spatial multiplexing

Precoding for spatial multiplexing is only used in combination with layer mapping for spatial multiplexing as described in Section 6.3.3.2. Spatial multiplexing supports two or four antenna ports and the set of antenna ports used is  $p \in \{0, 1\}$  or  $p \in \{0, 1, 2, 3\}$ , respectively.

#### 6.3.4.2.1 Precoding without CDD

Without cyclic delay diversity (CDD), precoding for spatial multiplexing is defined by

$$\begin{bmatrix} y^{(0)}(i) \\ \vdots \\ y^{(P-1)}(i) \end{bmatrix} = W(i) \begin{bmatrix} x^{(0)}(i) \\ \vdots \\ x^{(\nu-1)}(i) \end{bmatrix}$$

where the precoding matrix  $W(i)$  is of size  $P \times \nu$  and  $i = 0, 1, \dots, M_{\text{symb}}^{\text{ap}} - 1$ ,  $M_{\text{symb}}^{\text{ap}} = M_{\text{symb}}^{\text{layer}}$ .

For spatial multiplexing, the values of  $W(i)$  shall be selected among the precoder elements in the codebook configured in the eNodeB and the UE. The eNodeB can further confine the precoder selection in the UE to a subset of the elements in the codebook using codebook subset restrictions. The configured codebook shall be selected from Table 6.3.4.2.3-1 or 6.3.4.2.3-2.

#### 6.3.4.2.2 Precoding for large delay CDD

For large-delay CDD, precoding for spatial multiplexing is defined by

$$\begin{bmatrix} y^{(0)}(i) \\ \vdots \\ y^{(P-1)}(i) \end{bmatrix} = W(i)D(i)U \begin{bmatrix} x^{(0)}(i) \\ \vdots \\ x^{(\nu-1)}(i) \end{bmatrix}$$

where the precoding matrix  $W(i)$  is of size  $P \times \nu$  and  $i = 0, 1, \dots, M_{\text{symb}}^{\text{ap}} - 1$ ,  $M_{\text{symb}}^{\text{ap}} = M_{\text{symb}}^{\text{layer}}$ . The diagonal size- $\nu \times \nu$  matrix  $D(i)$  supporting cyclic delay diversity and the size- $\nu \times \nu$  matrix  $U$  are both given by Table 6.3.4.2.2-1 for different numbers of layers  $\nu$ .

The values of the precoding matrix  $W(i)$  shall be selected among the precoder elements in the codebook configured in the eNodeB and the UE. The eNodeB can further confine the precoder selection in the UE to a subset of the elements in the codebook using codebook subset restriction. The configured codebook shall be selected from Table 6.3.4.2.3-1 or 6.3.4.2.3-2.

- For 2 antenna ports, the precoder is selected according to  $W(i) = C_1$  where  $C_1$  denotes the precoding matrix corresponding to precoder index 0 in Table 6.3.4.2.3-1.
- For 4 antenna ports, the UE may assume that the eNB cyclically assigns different precoders to different vectors  $[x^{(0)}(i) \dots x^{(v-1)}(i)]^T$  on the physical downlink shared channel as follows. A different precoder is used every  $v$  vectors, where  $v$  denotes the number of transmission layers in the case of spatial multiplexing. In particular, the precoder is selected according to  $W(i) = C_k$ , where  $k$  is the precoder index given by

$k = \left( \left\lfloor \frac{i}{v} \right\rfloor \bmod 4 \right) + 1$ , where  $k=1,2,3,4$ , and  $C_1, C_2, C_3, C_4$  denote precoder matrices corresponding to precoder indices 12,13,14 and 15, respectively, in Table 6.3.4.2.3-2.

**Table 6.3.4.2.2-1: Large-delay cyclic delay diversity**

Number of layers $v$	$U$	$D(i)$
2	$\frac{1}{\sqrt{2}} \begin{bmatrix} 1 & 1 \\ 1 & e^{-j2\pi/2} \end{bmatrix}$	$\begin{bmatrix} 1 & 0 \\ 0 & e^{-j2\pi/2} \end{bmatrix}$
3	$\frac{1}{\sqrt{3}} \begin{bmatrix} 1 & 1 & 1 \\ 1 & e^{-j2\pi/3} & e^{-j4\pi/3} \\ 1 & e^{-j4\pi/3} & e^{-j8\pi/3} \end{bmatrix}$	$\begin{bmatrix} 1 & 0 & 0 \\ 0 & e^{-j2\pi/3} & 0 \\ 0 & 0 & e^{-j4\pi/3} \end{bmatrix}$
4	$\frac{1}{2} \begin{bmatrix} 1 & 1 & 1 & 1 \\ 1 & e^{-j2\pi/4} & e^{-j4\pi/4} & e^{-j6\pi/4} \\ 1 & e^{-j4\pi/4} & e^{-j8\pi/4} & e^{-j12\pi/4} \\ 1 & e^{-j6\pi/4} & e^{-j12\pi/4} & e^{-j18\pi/4} \end{bmatrix}$	$\begin{bmatrix} 1 & 0 & 0 & 0 \\ 0 & e^{-j2\pi/4} & 0 & 0 \\ 0 & 0 & e^{-j4\pi/4} & 0 \\ 0 & 0 & 0 & e^{-j6\pi/4} \end{bmatrix}$

### 6.3.4.2.3 Codebook for precoding

For transmission on two antenna ports,  $p \in \{0,1\}$ , the precoding matrix  $W(i)$  shall be selected from Table 6.3.4.2.3-1 or a subset thereof. For the closed-loop spatial multiplexing transmission mode defined in [4], the codebook index 0 is not used when the number layers is  $v = 2$ .

**Table 6.3.4.2.3-1: Codebook for transmission on antenna ports  $\{0,1\}$ .**

Codebook index	Number of layers $v$	
	1	2
0	$\frac{1}{\sqrt{2}} \begin{bmatrix} 1 \\ 1 \end{bmatrix}$	$\frac{1}{\sqrt{2}} \begin{bmatrix} 1 & 0 \\ 0 & 1 \end{bmatrix}$
1	$\frac{1}{\sqrt{2}} \begin{bmatrix} 1 \\ -1 \end{bmatrix}$	$\frac{1}{2} \begin{bmatrix} 1 & 1 \\ 1 & -1 \end{bmatrix}$
2	$\frac{1}{\sqrt{2}} \begin{bmatrix} 1 \\ j \end{bmatrix}$	$\frac{1}{2} \begin{bmatrix} 1 & 1 \\ j & -j \end{bmatrix}$
3	$\frac{1}{\sqrt{2}} \begin{bmatrix} 1 \\ -j \end{bmatrix}$	-

For transmission on four antenna ports,  $p \in \{0,1,2,3\}$ , the precoding matrix  $W$  shall be selected from Table 6.3.4.2.3-2 or a subset thereof. The quantity  $W_n^{\{s\}}$  denotes the matrix defined by the columns given by the set  $\{s\}$  from the expression  $W_n = I - 2u_n u_n^H / u_n^H u_n$  where  $I$  is the  $4 \times 4$  identity matrix and the vector  $u_n$  is given by Table 6.3.4.2.3-2.

Table 6.3.4.2.3-2: Codebook for transmission on antenna ports {0,1,2,3}.

Codebook index	$u_n$	Number of layers $\nu$			
		1	2	3	4
0	$u_0 = [1 \ -1 \ -1 \ -1]^T$	$W_0^{\{1\}}$	$W_0^{\{14\}}/\sqrt{2}$	$W_0^{\{124\}}/\sqrt{3}$	$W_0^{\{1234\}}/2$
1	$u_1 = [1 \ -j \ 1 \ j]^T$	$W_1^{\{1\}}$	$W_1^{\{12\}}/\sqrt{2}$	$W_1^{\{123\}}/\sqrt{3}$	$W_1^{\{1234\}}/2$
2	$u_2 = [1 \ 1 \ -1 \ 1]^T$	$W_2^{\{1\}}$	$W_2^{\{12\}}/\sqrt{2}$	$W_2^{\{123\}}/\sqrt{3}$	$W_2^{\{3214\}}/2$
3	$u_3 = [1 \ j \ 1 \ -j]^T$	$W_3^{\{1\}}$	$W_3^{\{12\}}/\sqrt{2}$	$W_3^{\{123\}}/\sqrt{3}$	$W_3^{\{3214\}}/2$
4	$u_4 = [1 \ (-1-j)/\sqrt{2} \ -j \ (1-j)/\sqrt{2}]^T$	$W_4^{\{1\}}$	$W_4^{\{14\}}/\sqrt{2}$	$W_4^{\{124\}}/\sqrt{3}$	$W_4^{\{1234\}}/2$
5	$u_5 = [1 \ (1-j)/\sqrt{2} \ j \ (-1-j)/\sqrt{2}]^T$	$W_5^{\{1\}}$	$W_5^{\{14\}}/\sqrt{2}$	$W_5^{\{124\}}/\sqrt{3}$	$W_5^{\{1234\}}/2$
6	$u_6 = [1 \ (1+j)/\sqrt{2} \ -j \ (-1+j)/\sqrt{2}]^T$	$W_6^{\{1\}}$	$W_6^{\{13\}}/\sqrt{2}$	$W_6^{\{134\}}/\sqrt{3}$	$W_6^{\{1324\}}/2$
7	$u_7 = [1 \ (-1+j)/\sqrt{2} \ j \ (1+j)/\sqrt{2}]^T$	$W_7^{\{1\}}$	$W_7^{\{13\}}/\sqrt{2}$	$W_7^{\{134\}}/\sqrt{3}$	$W_7^{\{1324\}}/2$
8	$u_8 = [1 \ -1 \ 1 \ 1]^T$	$W_8^{\{1\}}$	$W_8^{\{12\}}/\sqrt{2}$	$W_8^{\{124\}}/\sqrt{3}$	$W_8^{\{1234\}}/2$
9	$u_9 = [1 \ -j \ -1 \ -j]^T$	$W_9^{\{1\}}$	$W_9^{\{14\}}/\sqrt{2}$	$W_9^{\{134\}}/\sqrt{3}$	$W_9^{\{1234\}}/2$
10	$u_{10} = [1 \ 1 \ 1 \ -1]^T$	$W_{10}^{\{1\}}$	$W_{10}^{\{13\}}/\sqrt{2}$	$W_{10}^{\{123\}}/\sqrt{3}$	$W_{10}^{\{1324\}}/2$
11	$u_{11} = [1 \ j \ -1 \ j]^T$	$W_{11}^{\{1\}}$	$W_{11}^{\{13\}}/\sqrt{2}$	$W_{11}^{\{134\}}/\sqrt{3}$	$W_{11}^{\{1324\}}/2$
12	$u_{12} = [1 \ -1 \ -1 \ 1]^T$	$W_{12}^{\{1\}}$	$W_{12}^{\{12\}}/\sqrt{2}$	$W_{12}^{\{123\}}/\sqrt{3}$	$W_{12}^{\{1234\}}/2$
13	$u_{13} = [1 \ -1 \ 1 \ -1]^T$	$W_{13}^{\{1\}}$	$W_{13}^{\{13\}}/\sqrt{2}$	$W_{13}^{\{123\}}/\sqrt{3}$	$W_{13}^{\{1324\}}/2$
14	$u_{14} = [1 \ 1 \ -1 \ -1]^T$	$W_{14}^{\{1\}}$	$W_{14}^{\{13\}}/\sqrt{2}$	$W_{14}^{\{123\}}/\sqrt{3}$	$W_{14}^{\{3214\}}/2$
15	$u_{15} = [1 \ 1 \ 1 \ 1]^T$	$W_{15}^{\{1\}}$	$W_{15}^{\{12\}}/\sqrt{2}$	$W_{15}^{\{123\}}/\sqrt{3}$	$W_{15}^{\{1234\}}/2$

### 6.3.4.3 Precoding for transmit diversity

Precoding for transmit diversity is only used in combination with layer mapping for transmit diversity as described in Section 6.3.3.3. The precoding operation for transmit diversity is defined for two and four antenna ports.

For transmission on two antenna ports,  $p \in \{0,1\}$ , the output  $y(i) = [y^{(0)}(i) \ y^{(1)}(i)]^T$ ,  $i = 0,1,\dots,M_{\text{symp}}^{\text{ap}} - 1$  of the precoding operation is defined by

$$\begin{bmatrix} y^{(0)}(2i) \\ y^{(1)}(2i) \\ y^{(0)}(2i+1) \\ y^{(1)}(2i+1) \end{bmatrix} = \frac{1}{\sqrt{2}} \begin{bmatrix} 1 & 0 & j & 0 \\ 0 & -1 & 0 & j \\ 0 & 1 & 0 & j \\ 1 & 0 & -j & 0 \end{bmatrix} \begin{bmatrix} \text{Re}(x^{(0)}(i)) \\ \text{Re}(x^{(1)}(i)) \\ \text{Im}(x^{(0)}(i)) \\ \text{Im}(x^{(1)}(i)) \end{bmatrix}$$

for  $i = 0,1,\dots,M_{\text{symp}}^{\text{layer}} - 1$  with  $M_{\text{symp}}^{\text{ap}} = 2M_{\text{symp}}^{\text{layer}}$ .

For transmission on four antenna ports,  $p \in \{0,1,2,3\}$ , the output  $y(i) = [y^{(0)}(i) \ y^{(1)}(i) \ y^{(2)}(i) \ y^{(3)}(i)]^T$ ,  $i = 0,1,\dots,M_{\text{symp}}^{\text{ap}} - 1$  of the precoding operation is defined by

$$\begin{bmatrix} y^{(0)}(4i) \\ y^{(1)}(4i) \\ y^{(2)}(4i) \\ y^{(3)}(4i) \\ y^{(0)}(4i+1) \\ y^{(1)}(4i+1) \\ y^{(2)}(4i+1) \\ y^{(3)}(4i+1) \\ y^{(0)}(4i+2) \\ y^{(1)}(4i+2) \\ y^{(2)}(4i+2) \\ y^{(3)}(4i+2) \\ y^{(0)}(4i+3) \\ y^{(1)}(4i+3) \\ y^{(2)}(4i+3) \\ y^{(3)}(4i+3) \end{bmatrix} = \frac{1}{\sqrt{2}} \begin{bmatrix} 1 & 0 & 0 & 0 & j & 0 & 0 & 0 \\ 0 & 0 & 0 & 0 & 0 & 0 & 0 & 0 \\ 0 & -1 & 0 & 0 & 0 & j & 0 & 0 \\ 0 & 0 & 0 & 0 & 0 & 0 & 0 & 0 \\ 0 & 1 & 0 & 0 & 0 & j & 0 & 0 \\ 0 & 0 & 0 & 0 & 0 & 0 & 0 & 0 \\ 1 & 0 & 0 & 0 & -j & 0 & 0 & 0 \\ 0 & 0 & 0 & 0 & 0 & 0 & 0 & 0 \\ 0 & 0 & 0 & 0 & 0 & 0 & 0 & 0 \\ 0 & 0 & 1 & 0 & 0 & 0 & j & 0 \\ 0 & 0 & 0 & 0 & 0 & 0 & 0 & 0 \\ 0 & 0 & 0 & -1 & 0 & 0 & 0 & j \\ 0 & 0 & 0 & 0 & 0 & 0 & 0 & 0 \\ 0 & 0 & 0 & 1 & 0 & 0 & 0 & j \\ 0 & 0 & 0 & 0 & 0 & 0 & 0 & 0 \\ 0 & 0 & 1 & 0 & 0 & 0 & -j & 0 \end{bmatrix} \begin{bmatrix} \text{Re}(x^{(0)}(i)) \\ \text{Re}(x^{(1)}(i)) \\ \text{Re}(x^{(2)}(i)) \\ \text{Re}(x^{(3)}(i)) \\ \text{Im}(x^{(0)}(i)) \\ \text{Im}(x^{(1)}(i)) \\ \text{Im}(x^{(2)}(i)) \\ \text{Im}(x^{(3)}(i)) \end{bmatrix}$$

$$\text{for } i = 0, 1, \dots, M_{\text{symb}}^{\text{layer}} - 1 \text{ with } M_{\text{symb}}^{\text{ap}} = \begin{cases} 4M_{\text{symb}}^{\text{layer}} & \text{if } M_{\text{symb}}^{(0)} \bmod 4 = 0 \\ (4M_{\text{symb}}^{\text{layer}}) - 2 & \text{if } M_{\text{symb}}^{(0)} \bmod 4 \neq 0 \end{cases}$$

### 6.3.5 Mapping to resource elements

For each of the antenna ports used for transmission of the physical channel, the block of complex-valued symbols  $y^{(p)}(0), \dots, y^{(p)}(M_{\text{symb}}^{\text{ap}} - 1)$  shall be mapped in sequence starting with  $y^{(p)}(0)$  to resource elements  $(k, l)$  which meet all of the following criteria:

- they are in the physical resource blocks corresponding to the virtual resource blocks assigned for transmission, and
- they are not used for transmission of PBCH, synchronization signals or reference signals, and
- they are not in an OFDM symbol used for PDCCH as defined in section 6.7.

The mapping to resource elements  $(k, l)$  on antenna port  $p$  not reserved for other purposes shall be in increasing order of first the index  $k$  over the assigned physical resource blocks and then the index  $l$ , starting with the first slot in a subframe.

## 6.4 Physical downlink shared channel

The physical downlink shared channel shall be processed and mapped to resource elements as described in Section 6.3 with the following exceptions:

- In resource blocks in which UE-specific reference signals are not transmitted, the PDSCH shall be transmitted on the same set of antenna ports as the PBCH, which is one of  $\{0\}$ ,  $\{0,1\}$ , or  $\{0,1,2,3\}$
- In resource blocks in which UE-specific reference signals are transmitted, the PDSCH shall be transmitted on antenna port  $\{5\}$

## 6.5 Physical multicast channel

The physical multicast channel shall be processed and mapped to resource elements as described in Section 6.3 with the following exceptions:

- No transmit diversity scheme is specified

- Layer mapping and precoding shall be done assuming a single antenna port and the transmission shall use antenna port 4.
- In the subframes where PMCH is transmitted on a carrier supporting a mix of PDSCH and PMCH transmissions, up to two of the first OFDM symbols of a subframe can be reserved for non-MBSFN transmission and shall not be used for PMCH transmission. In a cell with 4 cell-specific antenna ports, the first two OFDM symbols of a subframe are reserved for non-MBSFN transmission in the subframes in which the PMCH is transmitted. The non-MBSFN symbols shall use the same cyclic prefix as used for subframe #0. PMCH shall not be transmitted in subframes 0 and 5 on a carrier supporting a mix of PDSCH and PMCH transmission

## 6.6 Physical broadcast channel

### 6.6.1 Scrambling

The block of bits  $b(0), \dots, b(M_{\text{bit}} - 1)$ , where  $M_{\text{bit}}$ , the number of bits transmitted on the physical broadcast channel, equals 1920 for normal cyclic prefix and 1728 for extended cyclic prefix, shall be scrambled with a cell-specific sequence prior to modulation, resulting in a block of scrambled bits  $\tilde{b}(0), \dots, \tilde{b}(M_{\text{bit}} - 1)$  according to

$$\tilde{b}(i) = (b(i) + c(i)) \bmod 2$$

where the scrambling sequence  $c(i)$  is given by Section 7.2. The scrambling sequence shall be initialised with  $c_{\text{init}} = N_{\text{ID}}^{\text{cell}}$  in each radio frame fulfilling  $n_f \bmod 4 = 0$ .

### 6.6.2 Modulation

The block of scrambled bits  $\tilde{b}(0), \dots, \tilde{b}(M_{\text{bit}} - 1)$  shall be modulated as described in Section 7.1, resulting in a block of complex-valued modulation symbols  $d(0), \dots, d(M_{\text{symb}} - 1)$ . Table 6.6.2-1 specifies the modulation mappings applicable for the physical broadcast channel.

**Table 6.6.2-1: PBCH modulation schemes**

Physical channel	Modulation schemes
PBCH	QPSK

### 6.6.3 Layer mapping and precoding

The block of modulation symbols  $d(0), \dots, d(M_{\text{symb}} - 1)$  shall be mapped to layers according to one of Sections 6.3.3.1 or 6.3.3.3 with  $M_{\text{symb}}^{(0)} = M_{\text{symb}}$  and precoded according to one of Sections 6.3.4.1 or 6.3.4.3, resulting in a block of vectors  $y(i) = [y^{(0)}(i) \ \dots \ y^{(P-1)}(i)]^T$ ,  $i = 0, \dots, M_{\text{symb}} - 1$ , where  $y^{(p)}(i)$  represents the signal for antenna port  $p$  and where  $p = 0, \dots, P-1$  and the number of antenna ports for cell-specific reference signals  $P \in \{1, 2, 4\}$ .

### 6.6.4 Mapping to resource elements

The block of complex-valued symbols  $y^{(p)}(0), \dots, y^{(p)}(M_{\text{symb}} - 1)$  for each antenna port is transmitted during 4 consecutive radio frames starting in each radio frame fulfilling  $n_f \bmod 4 = 0$  and shall be mapped in sequence starting with  $y(0)$  to resource elements  $(k, l)$ . The mapping to resource elements  $(k, l)$  not reserved for transmission of reference signals shall be in increasing order of first the index  $k$ , then the index  $l$  in slot 1 in subframe 0 and finally the radio frame number. The resource-element indices are given by

$$k = \frac{N_{RB}^{DL} N_{sc}^{RB}}{2} - 36 + k', \quad k' = 0, 1, \dots, 71$$

$$l = 0, 1, \dots, 3$$

where resource elements reserved for reference signals shall be excluded. The mapping operation shall assume cell-specific reference signals for antenna ports 0-3 being present irrespective of the actual configuration. The UE shall assume that the resource elements assumed to be reserved for reference signals in the mapping operation above but not used for transmission of reference signal are not available for PDSCH transmission. The UE shall not make any other assumptions about these resource elements.

## 6.7 Physical control format indicator channel

The physical control format indicator channel carries information about the number of OFDM symbols used for transmission of PDCCHs in a subframe. The set of OFDM symbols possible to use for PDCCH in a subframe is given by Table 6.7-1.

**Table 6.7-1: Number of OFDM symbols used for PDCCH.**

Subframe	Number of OFDM symbols for PDCCH when $N_{RB}^{DL} > 10$	Number of OFDM symbols for PDCCH when $N_{RB}^{DL} \leq 10$
Subframe 1 and 6 for frame structure type 2	1, 2	2
MBSFN subframes on a carrier supporting both PMCH and PDSCH for 1 or 2 cell specific antenna ports	1, 2	2
MBSFN subframes on a carrier supporting both PMCH and PDSCH for 4 cell specific antenna ports	2	2
MBSFN subframes on a carrier not supporting PDSCH	0	0
All other cases	1, 2, 3	2, 3, 4

The PCFICH shall be transmitted when the number of OFDM symbols for PDCCH is greater than zero.

### 6.7.1 Scrambling

The block of bits  $b(0), \dots, b(31)$  transmitted in one subframe shall be scrambled with a cell-specific sequence prior to modulation, resulting in a block of scrambled bits  $\tilde{b}(0), \dots, \tilde{b}(31)$  according to

$$\tilde{b}(i) = (b(i) + c(i)) \bmod 2$$

where the scrambling sequence  $c(i)$  is given by Section 7.2. The scrambling sequence generator shall be initialised with  $c_{\text{init}} = (\lfloor n_s/2 \rfloor + 1) \cdot (2N_{ID}^{\text{cell}} + 1) \cdot 2^9 + N_{ID}^{\text{cell}}$  at the start of each subframe.

### 6.7.2 Modulation

The block of scrambled bits  $\tilde{b}(0), \dots, \tilde{b}(31)$  shall be modulated as described in Section 7.1, resulting in a block of complex-valued modulation symbols  $d(0), \dots, d(15)$ . Table 6.7.2-1 specifies the modulation mappings applicable for the physical control format indicator channel.

**Table 6.7.2-1: PCFICH modulation schemes**

Physical channel	Modulation schemes
PCFICH	QPSK

### 6.7.3 Layer mapping and precoding

The block of modulation symbols  $d(0), \dots, d(15)$  shall be mapped to layers according to one of Sections 6.3.3.1 or 6.3.3.3 with  $M_{\text{sybm}}^{(0)} = 16$  and precoded according to one of Sections 6.3.4.1 or 6.3.4.3, resulting in a block of vectors

$y(i) = [y^{(0)}(i) \dots y^{(P-1)}(i)]^T$ ,  $i = 0, \dots, 15$ , where  $y^{(p)}(i)$  represents the signal for antenna port  $p$  and where  $p = 0, \dots, P-1$  and the number of antenna ports for cell-specific reference signals  $P \in \{1, 2, 4\}$ . The PCFICH shall be transmitted on the same set of antenna ports as the PBCH.

### 6.7.4 Mapping to resource elements

The mapping to resource elements is defined in terms of quadruplets of complex-valued symbols. Let  $z^{(p)}(i) = \langle y^{(p)}(4i), y^{(p)}(4i+1), y^{(p)}(4i+2), y^{(p)}(4i+3) \rangle$  denote symbol quadruplet  $i$  for antenna port  $p$ . For each of the antenna ports, symbol quadruplets shall be mapped in increasing order of  $i$  to the four resource-element groups in the first OFDM symbol in a downlink subframe with the representative resource-element as defined in Section 6.2.4 given by

$$\begin{aligned} z^{(p)}(0) & \text{ is mapped to the resource - element group represented by } k = \bar{k} \\ z^{(p)}(1) & \text{ is mapped to the resource - element group represented by } k = \bar{k} + \left\lfloor \frac{N_{\text{RB}}^{\text{DL}}}{2} \right\rfloor \cdot N_{\text{sc}}^{\text{RB}} / 2 \\ z^{(p)}(2) & \text{ is mapped to the resource - element group represented by } k = \bar{k} + \left\lfloor \frac{2N_{\text{RB}}^{\text{DL}}}{2} \right\rfloor \cdot N_{\text{sc}}^{\text{RB}} / 2 \\ z^{(p)}(3) & \text{ is mapped to the resource - element group represented by } k = \bar{k} + \left\lfloor \frac{3N_{\text{RB}}^{\text{DL}}}{2} \right\rfloor \cdot N_{\text{sc}}^{\text{RB}} / 2 \end{aligned}$$

where the additions are modulo  $N_{\text{RB}}^{\text{DL}} N_{\text{sc}}^{\text{RB}}$ ,

$$\bar{k} = \left( N_{\text{sc}}^{\text{RB}} / 2 \right) \cdot \left( N_{\text{ID}}^{\text{cell}} \bmod 2N_{\text{RB}}^{\text{DL}} \right)$$

and  $N_{\text{ID}}^{\text{cell}}$  is the physical-layer cell identity as given by Section 6.11.

## 6.8 Physical downlink control channel

### 6.8.1 PDCCH formats

The physical downlink control channel carries scheduling assignments and other control information. A physical control channel is transmitted on an aggregation of one or several consecutive control channel elements (CCEs), where a control channel element corresponds to 9 resource element groups. The number of resource-element groups not assigned to PCFICH or PHICH is  $N_{\text{REG}}$ . The CCEs available in the system are numbered from 0 and  $N_{\text{CCE}} - 1$ , where  $N_{\text{CCE}} = \lfloor N_{\text{REG}} / 9 \rfloor$ . The PDCCH supports multiple formats as listed in Table 6.8.1-1. A PDCCH consisting of  $n$  consecutive CCEs may only start on a CCE fulfilling  $i \bmod n = 0$ , where  $i$  is the CCE number.

Multiple PDCCHs can be transmitted in a subframe.

**Table 6.8.1-1: Supported PDCCH formats**

PDCCH format	Number of CCEs	Number of resource-element groups	Number of PDCCH bits
0	1	9	72
1	2	18	144
2	4	36	288
3	8	72	576

## 6.8.2 PDCCH multiplexing and scrambling

The block of bits  $b^{(i)}(0), \dots, b^{(i)}(M_{\text{bit}}^{(i)} - 1)$  on each of the control channels to be transmitted in a subframe, where  $M_{\text{bit}}^{(i)}$  is the number of bits in one subframe to be transmitted on physical downlink control channel number  $i$ , shall be multiplexed, resulting in a block of

bits  $b^{(0)}(0), \dots, b^{(0)}(M_{\text{bit}}^{(0)} - 1), b^{(1)}(0), \dots, b^{(1)}(M_{\text{bit}}^{(1)} - 1), \dots, b^{(n_{\text{PDCCH}}-1)}(0), \dots, b^{(n_{\text{PDCCH}}-1)}(M_{\text{bit}}^{(n_{\text{PDCCH}}-1)} - 1)$ , where  $n_{\text{PDCCH}}$  is the number of PDCCHs transmitted in the subframe.

The block of bits  $b^{(0)}(0), \dots, b^{(0)}(M_{\text{bit}}^{(0)} - 1), b^{(1)}(0), \dots, b^{(1)}(M_{\text{bit}}^{(1)} - 1), \dots, b^{(n_{\text{PDCCH}}-1)}(0), \dots, b^{(n_{\text{PDCCH}}-1)}(M_{\text{bit}}^{(n_{\text{PDCCH}}-1)} - 1)$  shall be scrambled with a cell-specific sequence prior to modulation, resulting in a block of scrambled bits  $\tilde{b}(0), \dots, \tilde{b}(M_{\text{tot}} - 1)$  according to

$$\tilde{b}(i) = (b(i) + c(i)) \bmod 2$$

where the scrambling sequence  $c(i)$  is given by Section 7.2. The scrambling sequence generator shall be initialised with  $c_{\text{init}} = \lfloor n_s / 2 \rfloor 2^9 + N_{\text{ID}}^{\text{cell}}$  at the start of each subframe.

CCE number  $n$  corresponds to bits  $b(72n), b(72n+1), \dots, b(72n+71)$ . If necessary, <NIL> elements shall be inserted in the block of bits prior to scrambling to ensure that the PDCCHs starts at the CCE positions as described in [4] and to ensure that the length  $M_{\text{tot}} = 8N_{\text{REG}} \geq \sum_{i=0}^{n_{\text{PDCCH}}-1} M_{\text{bit}}^{(i)}$  of the scrambled block of bits matches the amount of resource-element groups not assigned to PCFICH or PHICH.

## 6.8.3 Modulation

The block of scrambled bits  $\tilde{b}(0), \dots, \tilde{b}(M_{\text{tot}} - 1)$  shall be modulated as described in Section 7.1, resulting in a block of complex-valued modulation symbols  $d(0), \dots, d(M_{\text{symb}} - 1)$ . Table 6.8.3-1 specifies the modulation mappings applicable for the physical downlink control channel.

**Table 6.8.3-1: PDCCH modulation schemes**

Physical channel	Modulation schemes
PDCCH	QPSK

## 6.8.4 Layer mapping and precoding

The block of modulation symbols  $d(0), \dots, d(M_{\text{symb}} - 1)$  shall be mapped to layers according to one of Sections 6.3.3.1 or 6.3.3.3 with  $M_{\text{symb}}^{(0)} = M_{\text{symb}}$  and precoded according to one of Sections 6.3.4.1 or 6.3.4.3, resulting in a block of vectors  $y(i) = [y^{(0)}(i) \ \dots \ y^{(P-1)}(i)]^T$ ,  $i = 0, \dots, M_{\text{symb}} - 1$  to be mapped onto resources on the antenna ports used for transmission, where  $y^{(p)}(i)$  represents the signal for antenna port  $p$ . The PDCCH shall be transmitted on the same set of antenna ports as the PBCH.

## 6.8.5 Mapping to resource elements

The mapping to resource elements is defined by operations on quadruplets of complex-valued symbols. Let  $z^{(p)}(i) = \langle y^{(p)}(4i), y^{(p)}(4i+1), y^{(p)}(4i+2), y^{(p)}(4i+3) \rangle$  denote symbol quadruplet  $i$  for antenna port  $p$ .

The block of quadruplets  $z^{(p)}(0), \dots, z^{(p)}(M_{\text{quad}} - 1)$ , where  $M_{\text{quad}} = M_{\text{symb}} / 4$ , shall be permuted resulting in  $w^{(p)}(0), \dots, w^{(p)}(M_{\text{quad}} - 1)$ . The permutation shall be according to the sub-block interleaver in Section 5.1.4.2.1 of [3] with the following exceptions:

- the input and output to the interleaver is defined by symbol quadruplets instead of bits
- interleaving is performed on symbol quadruplets instead of bits by substituting the terms “bit”, “bits” and “bit sequence” in Section 5.1.4.2.1 of [3] by “symbol quadruplet”, “symbol quadruplets” and “symbol-quadruplet sequence”, respectively

<NULL> elements at the output of the interleaver in [3] shall be removed when forming  $w^{(p)}(0), \dots, w^{(p)}(M_{\text{quad}} - 1)$ . Note that the removal of <NULL> elements does not affect any <NIL> elements inserted in Section 6.8.2.

The block of quadruplets  $w^{(p)}(0), \dots, w^{(p)}(M_{\text{quad}} - 1)$  shall be cyclically shifted, resulting in  $\bar{w}^{(p)}(0), \dots, \bar{w}^{(p)}(M_{\text{quad}} - 1)$  where  $\bar{w}^{(p)}(i) = w^{(p)}\left(\left(i + N_{\text{ID}}^{\text{cell}}\right) \bmod M_{\text{quad}}\right)$ .

Mapping of the block of quadruplets  $\bar{w}^{(p)}(0), \dots, \bar{w}^{(p)}(M_{\text{quad}} - 1)$  is defined in terms of resource-element groups, specified in Section 6.2.4, according to steps 1–10 below:

- 1) Initialize  $m' = 0$  (resource-element group number)
- 2) Initialize  $k' = 0$
- 3) Initialize  $l' = 0$
- 4) If the resource element  $(k', l')$  represents a resource-element group and the resource-element group is not assigned to PCFICH or PHICH then perform step 5 and 6, else go to step 7
- 5) Map symbol-quadruplet  $\bar{w}^{(p)}(m')$  to the resource-element group represented by  $(k', l')$  for each antenna port  $p$
- 6) Increase  $m'$  by 1
- 7) Increase  $l'$  by 1
- 8) Repeat from step 4 if  $l' < L$ , where  $L$  corresponds to the number of OFDM symbols used for PDCCH transmission as indicated by the sequence transmitted on the PCFICH
- 9) Increase  $k'$  by 1
- 10) Repeat from step 3 if  $k' < N_{\text{RB}}^{\text{DL}} \cdot N_{\text{sc}}^{\text{RB}}$

## 6.9 Physical hybrid ARQ indicator channel

The PHICH carries the hybrid-ARQ ACK/NAK. Multiple PHICHs mapped to the same set of resource elements constitute a PHICH group, where PHICHs within the same PHICH group are separated through different orthogonal sequences. A PHICH resource is identified by the index pair  $(n_{\text{PHICH}}^{\text{group}}, n_{\text{PHICH}}^{\text{seq}})$ , where  $n_{\text{PHICH}}^{\text{group}}$  is the PHICH group number and  $n_{\text{PHICH}}^{\text{seq}}$  is the orthogonal sequence index within the group.

For frame structure type 1, the number of PHICH groups  $N_{\text{PHICH}}^{\text{group}}$  is constant in all subframes and given by

$$N_{\text{PHICH}}^{\text{group}} = \begin{cases} \left\lceil N_{\text{g}} \left( N_{\text{RB}}^{\text{DL}} / 8 \right) \right\rceil & \text{for normal cyclic prefix} \\ 2 \cdot \left\lceil N_{\text{g}} \left( N_{\text{RB}}^{\text{DL}} / 8 \right) \right\rceil & \text{for extended cyclic prefix} \end{cases}$$

where  $N_{\text{g}} \in \{1/6, 1/2, 1, 2\}$  is provided by higher layers. The index  $n_{\text{PHICH}}^{\text{group}}$  ranges from 0 to  $N_{\text{PHICH}}^{\text{group}} - 1$ .

For frame structure type 2, the number of PHICH groups may vary between downlink subframes and is given by  $m_i \cdot N_{\text{PHICH}}^{\text{group}}$  where  $m_i$  is given by Table 6.9-1 and  $N_{\text{PHICH}}^{\text{group}}$  by the expression above. The index  $n_{\text{PHICH}}^{\text{group}}$  in a downlink subframe with non-zero PHICH resources ranges from 0 to  $m_i \cdot N_{\text{PHICH}}^{\text{group}} - 1$ .

**Table 6.9-1: The factor  $m_i$  for frame structure type 2.**

Uplink-downlink configuration	Subframe number $i$									
	0	1	2	3	4	5	6	7	8	9
0	2	1	-	-	-	2	1	-	-	-
1	0	1	-	-	1	0	1	-	-	1
2	0	0	-	1	0	0	0	-	1	0
3	1	0	-	-	-	0	0	0	1	1
4	0	0	-	-	0	0	0	0	1	1
5	0	0	-	0	0	0	0	0	1	0
6	1	1	-	-	-	1	1	-	-	1

## 6.9.1 Modulation

The block of bits  $b(0), \dots, b(M_{\text{bit}} - 1)$  transmitted on one PHICH in one subframe shall be modulated as described in Section 7.1, resulting in a block of complex-valued modulation symbols  $z(0), \dots, z(M_s - 1)$ , where  $M_s = M_{\text{bit}}$ . Table 6.9.1-1 specifies the modulation mappings applicable for the physical hybrid ARQ indicator channel.

**Table 6.9.1-1: PHICH modulation schemes**

Physical channel	Modulation schemes
PHICH	BPSK

The block of modulation symbols  $z(0), \dots, z(M_s - 1)$  shall be bit-wise multiplied with an orthogonal sequence, resulting in a sequence of modulation symbols  $d(0), \dots, d(M_{\text{symb}} - 1)$  according to

$$d(i) = w(i \bmod N_{\text{SF}}^{\text{PHICH}}) \cdot (1 - 2c(i)) \cdot z(\lfloor i / N_{\text{SF}}^{\text{PHICH}} \rfloor)$$

where

$$i = 0, \dots, M_{\text{symb}} - 1$$

$$M_{\text{symb}} = N_{\text{SF}}^{\text{PHICH}} \cdot M_s$$

$$N_{\text{SF}}^{\text{PHICH}} = \begin{cases} 4 & \text{normal cyclic prefix} \\ 2 & \text{extended cyclic prefix} \end{cases}$$

and  $c(i)$  is a cell-specific scrambling sequence generated according to Section 7.2. The scrambling sequence generator shall be initialised with  $c_{\text{init}} = (\lfloor n_s / 2 \rfloor + 1) \cdot (2N_{\text{ID}}^{\text{cell}} + 1) \cdot 2^9 + N_{\text{ID}}^{\text{cell}}$  at the start of each subframe.

The sequence  $[w(0) \ \dots \ w(N_{\text{SF}}^{\text{PHICH}} - 1)]$  is given by Table 6.9.1-2 where the sequence index  $n_{\text{PHICH}}^{\text{seq}}$  corresponds to the PHICH number within the PHICH group.

**Table 6.9.1-2: Orthogonal sequences  $[w(0) \dots w(N_{\text{SF}}^{\text{PHICH}} - 1)]$  for PHICH**

Sequence index $n_{\text{PHICH}}^{\text{seq}}$	Orthogonal sequence	
	Normal cyclic prefix $N_{\text{SF}}^{\text{PHICH}} = 4$	Extended cyclic prefix $N_{\text{SF}}^{\text{PHICH}} = 2$
0	[+1 +1 +1 +1]	[+1 +1]
1	[+1 -1 +1 -1]	[+1 -1]
2	[+1 +1 -1 -1]	[+j +j]
3	[+1 -1 -1 +1]	[+j -j]
4	[+j +j +j +j]	-
5	[+j -j +j -j]	-
6	[+j +j -j -j]	-
7	[+j -j -j +j]	-

## 6.9.2 Resource group alignment, layer mapping and precoding

The block of symbols  $d(0), \dots, d(M_{\text{syimb}} - 1)$  should be first aligned with resource element group size, resulting in a block of symbols  $d^{(0)}(0), \dots, d^{(0)}(c \cdot M_{\text{syimb}} - 1)$ , where  $c=1$  for normal cyclic prefix; and  $c=2$  for extended cyclic prefix.

For normal cyclic prefix,  $d^{(0)}(i) = d(i)$ , for  $i = 0, \dots, M_{\text{syimb}} - 1$ .

For extended cyclic prefix,

$$\begin{bmatrix} d^{(0)}(4i) & d^{(0)}(4i+1) & d^{(0)}(4i+2) & d^{(0)}(4i+3) \end{bmatrix}^T = \begin{cases} \begin{bmatrix} d(2i) & d(2i+1) & 0 & 0 \end{bmatrix}^T & n_{\text{PHICH}}^{\text{group}} \bmod 2 = 0 \\ \begin{bmatrix} 0 & 0 & d(2i) & d(2i+1) \end{bmatrix}^T & n_{\text{PHICH}}^{\text{group}} \bmod 2 = 1 \end{cases}$$

, for  $i = 0, \dots, (M_{\text{syimb}}/2) - 1$ .

The block of symbols  $d^{(0)}(0), \dots, d^{(0)}(c \cdot M_{\text{syimb}} - 1)$  shall be mapped to layers and precoded, resulting in a block of vectors  $y(i) = [y^{(0)}(i) \dots y^{(P-1)}(i)]^T$ ,  $i = 0, \dots, c \cdot M_{\text{syimb}} - 1$ , where  $y^{(p)}(i)$  represents the signal for antenna port  $p$ ,  $p = 0, \dots, P-1$  and the number of antenna ports for cell-specific reference signals  $P \in \{1, 2, 4\}$ . The layer mapping and precoding operation depends on the cyclic prefix length and the number of antenna ports used for transmission of the PHICH. The PHICH shall be transmitted on the same set of antenna ports as the PBCH.

For transmission on a single antenna port,  $P = 1$ , layer mapping and precoding are defined by Sections 6.3.3.1 and 6.3.4.1, respectively, with  $M_{\text{syimb}}^{(0)} = c \cdot M_{\text{syimb}}$ .

For transmission on two antenna ports,  $P = 2$ , layer mapping and precoding are defined by Sections 6.3.3.3 and 6.3.4.3, respectively, with  $M_{\text{syimb}}^{(0)} = c \cdot M_{\text{syimb}}$ .

For transmission on four antenna ports,  $P = 4$ , layer mapping is defined by Section 6.3.3.3 with  $M_{\text{syimb}}^{(0)} = c \cdot M_{\text{syimb}}$  and precoding by

$$\begin{bmatrix} y^{(0)}(4i) \\ y^{(1)}(4i) \\ y^{(2)}(4i) \\ y^{(3)}(4i) \\ y^{(0)}(4i+1) \\ y^{(1)}(4i+1) \\ y^{(2)}(4i+1) \\ y^{(3)}(4i+1) \\ y^{(0)}(4i+2) \\ y^{(1)}(4i+2) \\ y^{(2)}(4i+2) \\ y^{(3)}(4i+2) \\ y^{(0)}(4i+3) \\ y^{(1)}(4i+3) \\ y^{(2)}(4i+3) \\ y^{(3)}(4i+3) \end{bmatrix} = \frac{1}{\sqrt{2}} \begin{bmatrix} 1 & 0 & 0 & 0 & j & 0 & 0 & 0 \\ 0 & 0 & 0 & 0 & 0 & 0 & 0 & 0 \\ 0 & -1 & 0 & 0 & 0 & j & 0 & 0 \\ 0 & 0 & 0 & 0 & 0 & 0 & 0 & 0 \\ 0 & 1 & 0 & 0 & 0 & j & 0 & 0 \\ 0 & 0 & 0 & 0 & 0 & 0 & 0 & 0 \\ 1 & 0 & 0 & 0 & -j & 0 & 0 & 0 \\ 0 & 0 & 0 & 0 & 0 & 0 & 0 & 0 \\ 0 & 0 & 1 & 0 & 0 & 0 & j & 0 \\ 0 & 0 & 0 & 0 & 0 & 0 & 0 & 0 \\ 0 & 0 & 0 & -1 & 0 & 0 & 0 & j \\ 0 & 0 & 0 & 0 & 0 & 0 & 0 & 0 \\ 0 & 0 & 0 & 1 & 0 & 0 & 0 & j \\ 0 & 0 & 0 & 0 & 0 & 0 & 0 & 0 \\ 0 & 0 & 1 & 0 & 0 & 0 & -j & 0 \\ 0 & 0 & 0 & 0 & 0 & 0 & 0 & 0 \end{bmatrix} \begin{bmatrix} \text{Re}(x^{(0)}(i)) \\ \text{Re}(x^{(1)}(i)) \\ \text{Re}(x^{(2)}(i)) \\ \text{Re}(x^{(3)}(i)) \\ \text{Im}(x^{(0)}(i)) \\ \text{Im}(x^{(1)}(i)) \\ \text{Im}(x^{(2)}(i)) \\ \text{Im}(x^{(3)}(i)) \end{bmatrix}$$

if  $(i + n_{\text{PHICH}}^{\text{group}}) \bmod 2 = 0$  for normal cyclic prefix, or  $(i + \lfloor n_{\text{PHICH}}^{\text{group}}/2 \rfloor) \bmod 2 = 0$  for extended cyclic prefix, where  $n_{\text{PHICH}}^{\text{group}}$  is the PHICH group number and  $i = 0, 1, 2$ , and by

$$\begin{bmatrix} y^{(0)}(4i) \\ y^{(1)}(4i) \\ y^{(2)}(4i) \\ y^{(3)}(4i) \\ y^{(0)}(4i+1) \\ y^{(1)}(4i+1) \\ y^{(2)}(4i+1) \\ y^{(3)}(4i+1) \\ y^{(0)}(4i+2) \\ y^{(1)}(4i+2) \\ y^{(2)}(4i+2) \\ y^{(3)}(4i+2) \\ y^{(0)}(4i+3) \\ y^{(1)}(4i+3) \\ y^{(2)}(4i+3) \\ y^{(3)}(4i+3) \end{bmatrix} = \frac{1}{\sqrt{2}} \begin{bmatrix} 0 & 0 & 0 & 0 & 0 & 0 & 0 & 0 \\ 1 & 0 & 0 & 0 & j & 0 & 0 & 0 \\ 0 & 0 & 0 & 0 & 0 & 0 & 0 & 0 \\ 0 & -1 & 0 & 0 & 0 & j & 0 & 0 \\ 0 & 0 & 0 & 0 & 0 & 0 & 0 & 0 \\ 0 & 1 & 0 & 0 & 0 & j & 0 & 0 \\ 0 & 0 & 0 & 0 & 0 & 0 & 0 & 0 \\ 1 & 0 & 0 & 0 & -j & 0 & 0 & 0 \\ 0 & 0 & 0 & 0 & 0 & 0 & 0 & 0 \\ 0 & 0 & 1 & 0 & 0 & 0 & j & 0 \\ 0 & 0 & 0 & 0 & 0 & 0 & 0 & 0 \\ 0 & 0 & 0 & -1 & 0 & 0 & 0 & j \\ 0 & 0 & 0 & 0 & 0 & 0 & 0 & 0 \\ 0 & 0 & 0 & 1 & 0 & 0 & 0 & j \\ 0 & 0 & 0 & 0 & 0 & 0 & 0 & 0 \\ 0 & 0 & 1 & 0 & 0 & 0 & -j & 0 \end{bmatrix} \begin{bmatrix} \text{Re}(x^{(0)}(i)) \\ \text{Re}(x^{(1)}(i)) \\ \text{Re}(x^{(2)}(i)) \\ \text{Re}(x^{(3)}(i)) \\ \text{Im}(x^{(0)}(i)) \\ \text{Im}(x^{(1)}(i)) \\ \text{Im}(x^{(2)}(i)) \\ \text{Im}(x^{(3)}(i)) \end{bmatrix}$$

otherwise for  $i = 0, 1, 2$ .

### 6.9.3 Mapping to resource elements

The sequence  $\bar{y}^{(p)}(0), \dots, \bar{y}^{(p)}(M_{\text{symb}}^{(0)} - 1)$  for each of the PHICH groups is defined by

$$\bar{y}^{(p)}(n) = \sum y_i^{(p)}(n)$$

where the sum is over all PHICHs in the PHICH group and  $y_i^{(p)}(n)$  represents the symbol sequence from the  $i$ :th PHICH in the PHICH group.

PHICH groups are mapped to PHICH mapping units.

For normal cyclic prefix, the mapping of PHICH group  $m$  to PHICH mapping unit  $m'$  is defined by

$$\tilde{y}_{m'}^{(p)}(n) = \bar{y}_m^{(p)}(n)$$

where  $m = m' = 0, 1, \dots, N_{\text{PHICH}}^{\text{group}} - 1$ .

For extended cyclic prefix, the mapping of PHICH group  $m$  and  $m+1$  to PHICH mapping unit  $m'$  is defined by

$$\tilde{y}_{m'}^{(p)}(n) = \bar{y}_m^{(p)}(n) + \bar{y}_{m+1}^{(p)}(n)$$

where  $m' = m/2$  and  $m = 0, 2, \dots, N_{\text{PHICH}}^{\text{group}} - 2$ .

Let  $z^{(p)}(i) = \langle \tilde{y}^{(p)}(4i), \tilde{y}^{(p)}(4i+1), \tilde{y}^{(p)}(4i+2), \tilde{y}^{(p)}(4i+3) \rangle$ ,  $i = 0, 1, 2$  denote symbol quadruplet  $i$  for antenna port  $p$ .

Mapping to resource elements is defined in terms of symbol quadruplets according to steps 1–10 below:

- 1) For each value of  $l'$
- 2) Let  $n_r$  denote the number of resource element groups not assigned to PCFICH in OFDM symbol  $l'$
- 3) Number the resource-element groups not assigned to PCFICH in OFDM symbol  $l'$  from 0 to  $n_r - 1$ , starting from the resource-element group with the lowest frequency-domain index.
- 4) Initialize  $m' = 0$  (PHICH mapping unit number)
- 5) For each value of  $i = 0, 1, 2$
- 6) Symbol-quadruplet  $z^{(p)}(i)$  from PHICH mapping unit  $m'$  is mapped to the resource-element group represented by  $(k', l')_i$  as defined in Section 6.2.4 where the indices  $k'_i$  and  $l'_i$  are given by steps 7 and 8 below:
- 7) The time-domain index  $l'_i$  is given by

$$l'_i = \begin{cases} 0 & \text{normal PHICH duration, all subframes} \\ \lfloor m'/2 \rfloor + i + 1 \pmod 2 & \text{extended PHICH duration, MBSFN subframes} \\ \lfloor m'/2 \rfloor + i + 1 \pmod 2 & \text{extended PHICH duration, subframe 1 and 6 in frame structure type 2} \\ i & \text{otherwise} \end{cases}$$

- 8) Set the frequency-domain index  $k'_i$  to the resource-element group assigned the number  $\bar{n}_i$  in step 3 above, where  $\bar{n}_i$  is given by

$$\bar{n}_i = \begin{cases} \left( \lfloor N_{\text{ID}}^{\text{cell}} \cdot n_r / n_1 \rfloor + m' \right) \pmod{n_r} & i = 0 \\ \left( \lfloor N_{\text{ID}}^{\text{cell}} \cdot n_r / n_1 \rfloor + m' + \lfloor n_r / 3 \rfloor \right) \pmod{n_r} & i = 1 \\ \left( \lfloor N_{\text{ID}}^{\text{cell}} \cdot n_r / n_1 \rfloor + m' + \lfloor 2n_r / 3 \rfloor \right) \pmod{n_r} & i = 2 \end{cases}$$

in case of extended PHICH duration in MBSFN subframes, or extended PHICH duration in subframe 1 and 6 for frame structure type 2 and by

$$\bar{n}_i = \begin{cases} \left( \lfloor N_{\text{ID}}^{\text{cell}} \cdot n_r / n_0 \rfloor + m' \right) \pmod{n_r} & i = 0 \\ \left( \lfloor N_{\text{ID}}^{\text{cell}} \cdot n_r / n_0 \rfloor + m' + \lfloor n_r / 3 \rfloor \right) \pmod{n_r} & i = 1 \\ \left( \lfloor N_{\text{ID}}^{\text{cell}} \cdot n_r / n_0 \rfloor + m' + \lfloor 2n_r / 3 \rfloor \right) \pmod{n_r} & i = 2 \end{cases}$$

otherwise.

9) Increase  $m'$  by 1.

10) Repeat from step 5 until all PHICH mapping units have been assigned.

The PHICH duration is configurable by higher layers according to Table 6.9.3-1. The duration configured puts a lower limit on the size of the control region signalled by the PCFICH.

**Table 6.9.3-1: PHICH duration in MBSFN and non-MBSFN subframes.**

PHICH duration	Non-MBSFN subframes		MBSFN subframes On a carrier supporting both PDSCH and PMCH
	Subframes 1 and 6 in case of frame structure type 2	All other cases	
Normal	1	1	1
Extended	2	3	2

## 6.10 Reference signals

Three types of downlink reference signals are defined:

- Cell-specific reference signals, associated with non-MBSFN transmission
- MBSFN reference signals, associated with MBSFN transmission
- UE-specific reference signals

There is one reference signal transmitted per downlink antenna port.

### 6.10.1 Cell-specific reference signals

Cell-specific reference signals shall be transmitted in all downlink subframes in a cell supporting non-MBSFN transmission. In case the subframe is used for transmission with MBSFN, only the first two OFDM symbols in a subframe can be used for transmission of cell-specific reference symbols.

Cell-specific reference signals are transmitted on one or several of antenna ports 0 to 3.

Cell-specific reference signals are defined for  $\Delta f = 15$  kHz only.

#### 6.10.1.1 Sequence generation

The reference-signal sequence  $r_{l,n_s}(m)$  is defined by

$$r_{l,n_s}(m) = \frac{1}{\sqrt{2}}(1 - 2 \cdot c(2m)) + j \frac{1}{\sqrt{2}}(1 - 2 \cdot c(2m+1)), \quad m = 0, 1, \dots, 2N_{\text{RB}}^{\text{max,DL}} - 1$$

where  $n_s$  is the slot number within a radio frame and  $l$  is the OFDM symbol number within the slot. The pseudo-random sequence  $c(i)$  is defined in Section 7.2. The pseudo-random sequence generator shall be initialised with  $c_{\text{init}} = 2^{10} \cdot (7 \cdot (n_s + 1) + l + 1) \cdot (2 \cdot N_{\text{ID}}^{\text{cell}} + 1) + 2 \cdot N_{\text{ID}}^{\text{cell}} + N_{\text{CP}}$  at the start of each OFDM symbol where

$$N_{\text{CP}} = \begin{cases} 1 & \text{for normal CP} \\ 0 & \text{for extended CP} \end{cases}$$

### 6.10.1.2 Mapping to resource elements

The reference signal sequence  $r_{l,n_s}(m)$  shall be mapped to complex-valued modulation symbols  $a_{k,l}^{(p)}$  used as reference symbols for antenna port  $p$  in slot  $n_s$  according to

$$a_{k,l}^{(p)} = r_{l,n_s}(m')$$

where

$$\begin{aligned} k &= 6m + (v + v_{\text{shift}}) \bmod 6 \\ l &= \begin{cases} 0, N_{\text{sy mb}}^{\text{DL}} - 3 & \text{if } p \in \{0,1\} \\ 1 & \text{if } p \in \{2,3\} \end{cases} \\ m &= 0, 1, \dots, 2 \cdot N_{\text{RB}}^{\text{DL}} - 1 \\ m' &= m + N_{\text{RB}}^{\text{max,DL}} - N_{\text{RB}}^{\text{DL}} \end{aligned}$$

The variables  $v$  and  $v_{\text{shift}}$  define the position in the frequency domain for the different reference signals where  $v$  is given by

$$v = \begin{cases} 0 & \text{if } p = 0 \text{ and } l = 0 \\ 3 & \text{if } p = 0 \text{ and } l \neq 0 \\ 3 & \text{if } p = 1 \text{ and } l = 0 \\ 0 & \text{if } p = 1 \text{ and } l \neq 0 \\ 3(n_s \bmod 2) & \text{if } p = 2 \\ 3 + 3(n_s \bmod 2) & \text{if } p = 3 \end{cases}$$

The cell-specific frequency shift is given by  $v_{\text{shift}} = N_{\text{ID}}^{\text{cell}} \bmod 6$ .

Resource elements  $(k, l)$  used for reference signal transmission on any of the antenna ports in a slot shall not be used for any transmission on any other antenna port in the same slot and set to zero.

Figures 6.10.1.2-1 and 6.10.1.2-2 illustrate the resource elements used for reference signal transmission according to the above definition. The notation  $R_p$  is used to denote a resource element used for reference signal transmission on antenna port  $p$ .

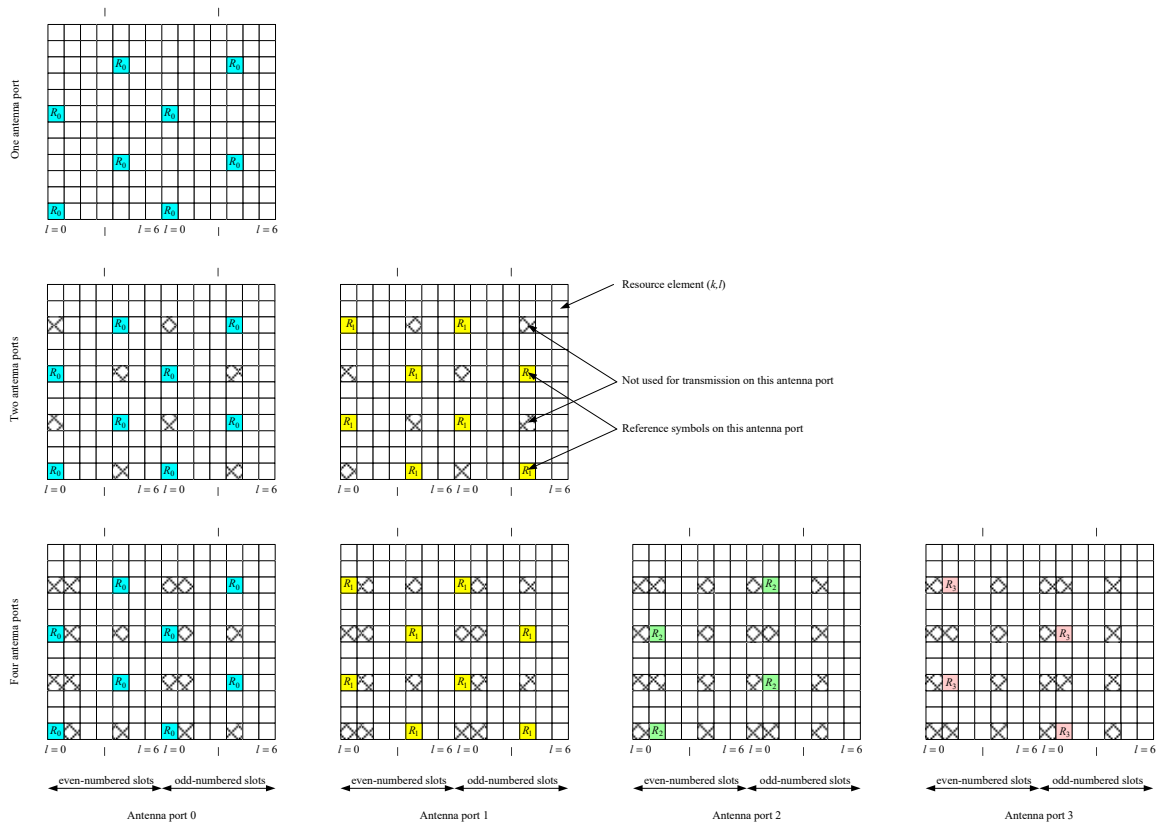

Figure 6.10.1.2-1. Mapping of downlink reference signals (normal cyclic prefix).

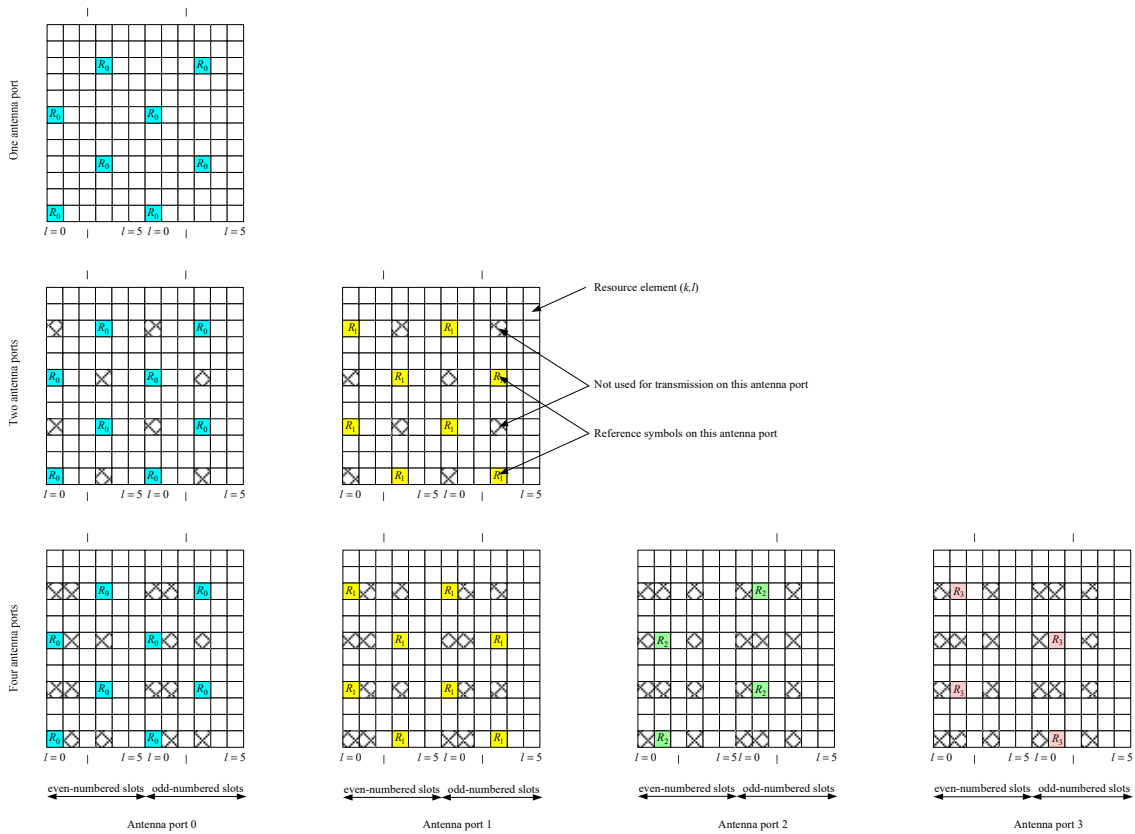

Figure 6.10.1-2. Mapping of downlink reference signals (extended cyclic prefix).

### 6.10.2 MBSFN reference signals

MBSFN reference signals shall only be transmitted in subframes allocated for MBSFN transmissions. MBSFN reference signals are transmitted on antenna port 4.

MBSFN reference signals are defined for extended cyclic prefix only.

#### 6.10.2.1 Sequence generation

The MBSFN reference-signal sequence  $r_{l,n_s}(m)$  is defined by

$$r_{l,n_s}(m) = \frac{1}{\sqrt{2}}(1 - 2 \cdot c(2m)) + j \frac{1}{\sqrt{2}}(1 - 2 \cdot c(2m + 1)), \quad m = 0, 1, \dots, 6N_{RB}^{\max,DL} - 1$$

where  $n_s$  is the slot number within a radio frame and  $l$  is the OFDM symbol number within the slot. The pseudo-random sequence  $c(i)$  is defined in Section 7.2. The pseudo-random sequence generator shall be initialised with  $c_{init} = 2^9 \cdot (7 \cdot (n_s + 1) + l + 1) \cdot (2 \cdot N_{ID}^{MBSFN} + 1) + N_{ID}^{MBSFN}$  at the start of each OFDM symbol.

#### 6.10.2.2 Mapping to resource elements

The reference-signal sequence  $r_{l,n_s}(m')$  in OFDM symbol  $l$  shall be mapped to complex-valued modulation symbols  $a_{k,l}^{(p)}$  with  $p = 4$  according to

$$a_{k,l}^{(p)} = r_{l,n_s}(m')$$

where

$$k = \begin{cases} 2m & \text{if } l \neq 0 \text{ and } \Delta f = 15 \text{ kHz} \\ 2m+1 & \text{if } l = 0 \text{ and } \Delta f = 15 \text{ kHz} \\ 4m & \text{if } l \neq 0 \text{ and } \Delta f = 7.5 \text{ kHz} \\ 4m+2 & \text{if } l = 0 \text{ and } \Delta f = 7.5 \text{ kHz} \end{cases}$$

$$l = \begin{cases} 2 & \text{if } n_s \bmod 2 = 0 \text{ and } \Delta f = 15 \text{ kHz} \\ 0,4 & \text{if } n_s \bmod 2 = 1 \text{ and } \Delta f = 15 \text{ kHz} \\ 1 & \text{if } n_s \bmod 2 = 0 \text{ and } \Delta f = 7.5 \text{ kHz} \\ 0,2 & \text{if } n_s \bmod 2 = 1 \text{ and } \Delta f = 7.5 \text{ kHz} \end{cases}$$

$$m = 0, 1, \dots, 6N_{RB}^{DL} - 1$$

$$m' = m + 3(N_{RB}^{max,DL} - N_{RB}^{DL})$$

Figure 6.10.2.2-1 illustrates the resource elements used for MBSFN reference signal transmission in case of  $\Delta f = 15 \text{ kHz}$ . In case of  $\Delta f = 7.5 \text{ kHz}$  for a MBSFN-dedicated cell, the MBSFN reference signal shall be mapped to resource elements according to Figure 6.10.2.2-3. The notation  $R_p$  is used to denote a resource element used for reference signal transmission on antenna port  $p$ .

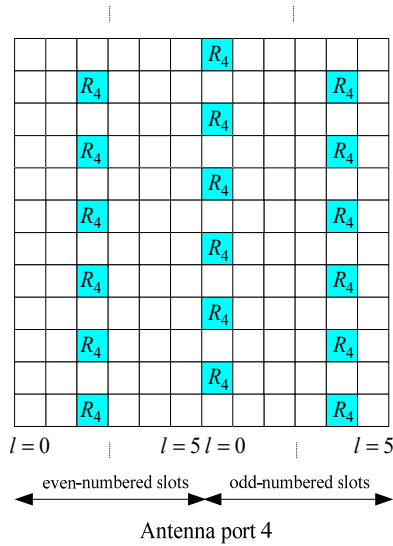

Figure 6.10.2.2-1: Mapping of MBSFN reference signals (extended cyclic prefix,  $\Delta f = 15 \text{ kHz}$ )

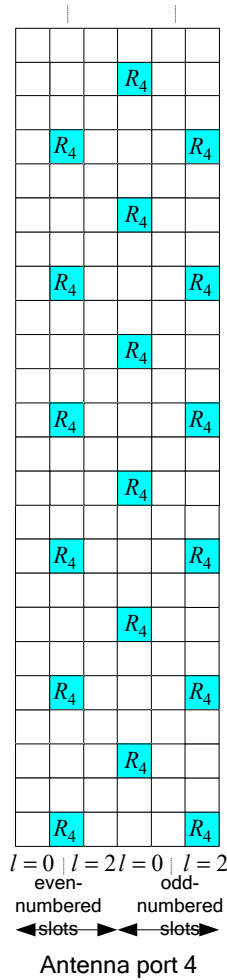

Figure 6.10.2.2-3: Mapping of MBSFN reference signals (extended cyclic prefix,  $\Delta f = 7.5$  kHz)

### 6.10.3 UE-specific reference signals

UE-specific reference signals are supported for single-antenna-port transmission of PDSCH and are transmitted on antenna port 5. The UE is informed by higher layers whether the UE-specific reference signal is present and is a valid reference for PDSCH demodulation or not. UE-specific reference signals are transmitted only on the resource blocks upon which the corresponding PDSCH is mapped. The UE-specific reference signal is not transmitted in resource elements  $(k, l)$  in which one of the physical channels or physical signals other than UE-specific reference signal defined in 6.1 are transmitted using resource elements with the same index pair  $(k, l)$  regardless of their antenna port  $p$ .

#### 6.10.3.1 Sequence generation

The UE-specific reference-signal sequence  $r(m)$  is defined by

$$r(m) = \frac{1}{\sqrt{2}}(1 - 2 \cdot c(2m)) + j \frac{1}{\sqrt{2}}(1 - 2 \cdot c(2m + 1)), \quad m = 0, 1, \dots, 12N_{RB}^{PDSCH} - 1$$

where  $N_{RB}^{PDSCH}$  denotes the bandwidth in resource blocks of the corresponding PDSCH transmission. The pseudo-random sequence  $c(i)$  is defined in Section 7.2. The pseudo-random sequence generator shall be initialised with

$c_{\text{init}} = (\lfloor n_s/2 \rfloor + 1) \cdot (2N_{\text{ID}}^{\text{cell}} + 1) \cdot 2^{16} + n_{\text{RNTI}}$  at the start of each subframe where  $n_{\text{RNTI}}$  is as described in Section 7.1[4].

### 6.10.3.2 Mapping to resource elements

In a physical resource block with frequency-domain index  $n_{\text{PRB}}$  assigned for the corresponding PDSCH transmission, the reference signal sequence  $r(m)$  shall be mapped to complex-valued modulation symbols  $a_{k,l}^{(p)}$  with  $p = 5$  in a subframe according to:

Normal cyclic prefix:

$$a_{k,l}^{(p)} = r(3 \cdot l' \cdot N_{\text{RB}}^{\text{PDSCH}} + m')$$

$$k = (k') \bmod N_{\text{sc}}^{\text{RB}} + N_{\text{sc}}^{\text{RB}} \cdot n_{\text{PRB}}$$

$$k' = \begin{cases} 4m' + v_{\text{shift}} & \text{if } l \in \{2,3\} \\ 4m' + (2 + v_{\text{shift}}) \bmod 4 & \text{if } l \in \{5,6\} \end{cases}$$

$$l = \begin{cases} 3 & l' = 0 \\ 6 & l' = 1 \\ 2 & l' = 2 \\ 5 & l' = 3 \end{cases}$$

$$l' = \begin{cases} 0,1 & \text{if } n_s \bmod 2 = 0 \\ 2,3 & \text{if } n_s \bmod 2 = 1 \end{cases}$$

$$m' = 0, 1, \dots, 3N_{\text{RB}}^{\text{PDSCH}} - 1$$

Extended cyclic prefix:

$$a_{k,l}^{(p)} = r(4 \cdot l' \cdot N_{\text{RB}}^{\text{PDSCH}} + m')$$

$$k = (k') \bmod N_{\text{sc}}^{\text{RB}} + N_{\text{sc}}^{\text{RB}} \cdot n_{\text{PRB}}$$

$$k' = \begin{cases} 3m' + v_{\text{shift}} & \text{if } l = 4 \\ 3m' + (2 + v_{\text{shift}}) \bmod 3 & \text{if } l = 1 \end{cases}$$

$$l = \begin{cases} 4 & l' \in \{0,2\} \\ 1 & l' = 1 \end{cases}$$

$$l' = \begin{cases} 0 & \text{if } n_s \bmod 2 = 0 \\ 1,2 & \text{if } n_s \bmod 2 = 1 \end{cases}$$

$$m' = 0, 1, \dots, 4N_{\text{RB}}^{\text{PDSCH}} - 1$$

where  $m'$  is the counter of UE-specific reference signal resource elements within a respective OFDM symbol of the PDSCH transmission.

The cell-specific frequency shift is given by  $v_{\text{shift}} = N_{\text{ID}}^{\text{cell}} \bmod 3$ .

The mapping shall be in increasing order of the frequency-domain index  $n_{\text{PRB}}$  of the physical resource blocks assigned for the corresponding PDSCH transmission. The quantity  $N_{\text{RB}}^{\text{PDSCH}}$  denotes the bandwidth in resource blocks of the corresponding PDSCH transmission.

Figure 6.10.3.2-1 illustrates the resource elements used for UE-specific reference signals for normal cyclic prefix.

Figure 6.10.3.2-2 illustrates the resource elements used for UE-specific reference signals for extended cyclic prefix.

The notation  $R_p$  is used to denote a resource element used for reference signal transmission on antenna port  $p$ .

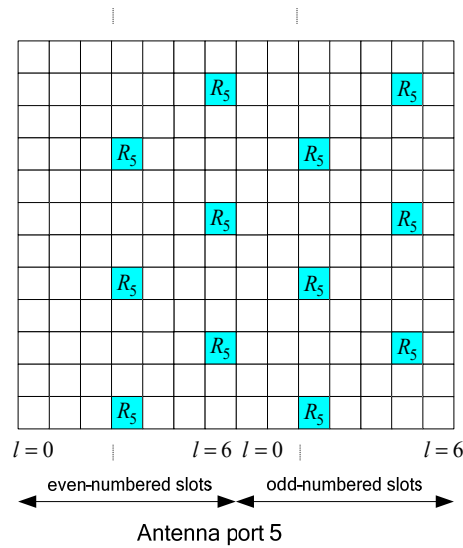

Figure 6.10.3.2-1: Mapping of UE-specific reference signals (normal cyclic prefix)

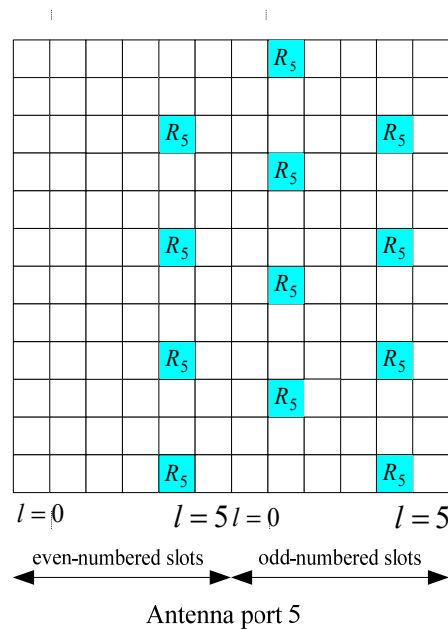

Figure 6.10.3.2-2: Mapping of UE-specific reference signals (extended cyclic prefix)

## 6.11 Synchronization signals

There are 504 unique physical-layer cell identities. The physical-layer cell identities are grouped into 168 unique physical-layer cell-identity groups, each group containing three unique identities. The grouping is such that each physical-layer cell identity is part of one and only one physical-layer cell-identity group. A physical-layer cell identity  $N_{ID}^{cell} = 3N_{ID}^{(1)} + N_{ID}^{(2)}$  is thus uniquely defined by a number  $N_{ID}^{(1)}$  in the range of 0 to 167, representing the physical-layer cell-identity group, and a number  $N_{ID}^{(2)}$  in the range of 0 to 2, representing the physical-layer identity within the physical-layer cell-identity group.

## 6.11.1 Primary synchronization signal

### 6.11.1.1 Sequence generation

The sequence  $d(n)$  used for the primary synchronization signal is generated from a frequency-domain Zadoff-Chu sequence according to

$$d_u(n) = \begin{cases} e^{-j\frac{\pi n(n+1)}{63}} & n = 0, 1, \dots, 30 \\ e^{-j\frac{\pi u(n+1)(n+2)}{63}} & n = 31, 32, \dots, 61 \end{cases}$$

where the Zadoff-Chu root sequence index  $u$  is given by Table 6.11.1.1-1.

**Table 6.11.1.1-1: Root indices for the primary synchronization signal.**

$N_{\text{ID}}^{(2)}$	Root index $u$
0	25
1	29
2	34

### 6.11.1.2 Mapping to resource elements

The mapping of the sequence to resource elements depends on the frame structure. The UE shall not assume that the primary synchronization signal is transmitted on the same antenna port as any of the downlink reference signals. The UE shall not assume that any transmission instance of the primary synchronization signal is transmitted on the same antenna port, or ports, used for any other transmission instance of the primary synchronization signal.

The sequence  $d(n)$  shall be mapped to the resource elements according to

$$a_{k,l} = d(n), \quad n = 0, \dots, 61$$

$$k = n - 31 + \frac{N_{\text{RB}}^{\text{DL}} N_{\text{sc}}^{\text{RB}}}{2}$$

For frame structure type 1, the primary synchronization signal shall be mapped to the last OFDM symbol in slots 0 and 10.

For frame structure type 2, the primary synchronization signal shall be mapped to the third OFDM symbol in subframes 1 and 6. Resource elements  $(k, l)$  in the OFDM symbols used for transmission of the primary synchronization signal where

$$k = n - 31 + \frac{N_{\text{RB}}^{\text{DL}} N_{\text{sc}}^{\text{RB}}}{2}$$

$$n = -5, -4, \dots, -1, 62, 63, \dots, 66$$

are reserved and not used for transmission of the primary synchronization signal.

## 6.11.2 Secondary synchronization signal

### 6.11.2.1 Sequence generation

The sequence  $d(0), \dots, d(61)$  used for the second synchronization signal is an interleaved concatenation of two length-31 binary sequences. The concatenated sequence is scrambled with a scrambling sequence given by the primary synchronization signal.

The combination of two length-31 sequences defining the secondary synchronization signal differs between subframe 0 and subframe 5 according to

$$d(2n) = \begin{cases} s_0^{(m_0)}(n)c_0(n) & \text{in subframe 0} \\ s_1^{(m_1)}(n)c_0(n) & \text{in subframe 5} \end{cases}$$

$$d(2n+1) = \begin{cases} s_1^{(m_1)}(n)c_1(n)z_1^{(m_0)}(n) & \text{in subframe 0} \\ s_0^{(m_0)}(n)c_1(n)z_1^{(m_1)}(n) & \text{in subframe 5} \end{cases}$$

where  $0 \leq n \leq 30$ . The indices  $m_0$  and  $m_1$  are derived from the physical-layer cell-identity group  $N_{\text{ID}}^{(1)}$  according to

$$m_0 = m' \bmod 31$$

$$m_1 = (m_0 + \lfloor m'/31 \rfloor + 1) \bmod 31$$

$$m' = N_{\text{ID}}^{(1)} + q(q+1)/2, \quad q = \left\lfloor \frac{N_{\text{ID}}^{(1)} + q'(q'+1)/2}{30} \right\rfloor, \quad q' = \lfloor N_{\text{ID}}^{(1)}/30 \rfloor$$

where the output of the above expression is listed in Table 6.11.2.1-1.

The two sequences  $s_0^{(m_0)}(n)$  and  $s_1^{(m_1)}(n)$  are defined as two different cyclic shifts of the m-sequence  $\tilde{s}(n)$  according to

$$s_0^{(m_0)}(n) = \tilde{s}((n + m_0) \bmod 31)$$

$$s_1^{(m_1)}(n) = \tilde{s}((n + m_1) \bmod 31)$$

where  $\tilde{s}(i) = 1 - 2x(i)$ ,  $0 \leq i \leq 30$ , is defined by

$$x(\bar{i} + 5) = (x(\bar{i} + 2) + x(\bar{i})) \bmod 2, \quad 0 \leq \bar{i} \leq 25$$

with initial conditions  $x(0) = 0$ ,  $x(1) = 0$ ,  $x(2) = 0$ ,  $x(3) = 0$ ,  $x(4) = 1$ .

The two scrambling sequences  $c_0(n)$  and  $c_1(n)$  depend on the primary synchronization signal and are defined by two different cyclic shifts of the m-sequence  $\tilde{c}(n)$  according to

$$c_0(n) = \tilde{c}((n + N_{\text{ID}}^{(2)}) \bmod 31)$$

$$c_1(n) = \tilde{c}((n + N_{\text{ID}}^{(2)} + 3) \bmod 31)$$

where  $N_{\text{ID}}^{(2)} \in \{0,1,2\}$  is the physical-layer identity within the physical-layer cell identity group  $N_{\text{ID}}^{(1)}$  and  $\tilde{c}(i) = 1 - 2x(i)$ ,  $0 \leq i \leq 30$ , is defined by

$$x(\bar{i} + 5) = (x(\bar{i} + 3) + x(\bar{i})) \bmod 2, \quad 0 \leq \bar{i} \leq 25$$

with initial conditions  $x(0) = 0$ ,  $x(1) = 0$ ,  $x(2) = 0$ ,  $x(3) = 0$ ,  $x(4) = 1$ .

The scrambling sequences  $z_1^{(m_0)}(n)$  and  $z_1^{(m_1)}(n)$  are defined by a cyclic shift of the m-sequence  $\tilde{z}(n)$  according to

$$z_1^{(m_0)}(n) = \tilde{z}((n + (m_0 \bmod 8)) \bmod 31)$$

$$z_1^{(m_1)}(n) = \tilde{z}((n + (m_1 \bmod 8)) \bmod 31)$$

where  $m_0$  and  $m_1$  are obtained from Table 6.11.2.1-1 and  $\tilde{z}(i) = 1 - 2x(i)$ ,  $0 \leq i \leq 30$ , is defined by

$$x(\bar{i} + 5) = (x(\bar{i} + 4) + x(\bar{i} + 2) + x(\bar{i} + 1) + x(\bar{i})) \bmod 2, \quad 0 \leq \bar{i} \leq 25$$

with initial conditions  $x(0) = 0$ ,  $x(1) = 0$ ,  $x(2) = 0$ ,  $x(3) = 0$ ,  $x(4) = 1$ .

**Table 6.11.2.1-1: Mapping between physical-layer cell-identity group  $N_{ID}^{(1)}$  and the indices  $m_0$  and  $m_1$ .**

$N_{ID}^{(1)}$	$m_0$	$m_1$	$N_{ID}^{(1)}$	$m_0$	$m_1$	$N_{ID}^{(1)}$	$m_0$	$m_1$	$N_{ID}^{(1)}$	$m_0$	$m_1$	$N_{ID}^{(1)}$	$m_0$	$m_1$
0	0	1	34	4	6	68	9	12	102	15	19	136	22	27
1	1	2	35	5	7	69	10	13	103	16	20	137	23	28
2	2	3	36	6	8	70	11	14	104	17	21	138	24	29
3	3	4	37	7	9	71	12	15	105	18	22	139	25	30
4	4	5	38	8	10	72	13	16	106	19	23	140	0	6
5	5	6	39	9	11	73	14	17	107	20	24	141	1	7
6	6	7	40	10	12	74	15	18	108	21	25	142	2	8
7	7	8	41	11	13	75	16	19	109	22	26	143	3	9
8	8	9	42	12	14	76	17	20	110	23	27	144	4	10
9	9	10	43	13	15	77	18	21	111	24	28	145	5	11
10	10	11	44	14	16	78	19	22	112	25	29	146	6	12
11	11	12	45	15	17	79	20	23	113	26	30	147	7	13
12	12	13	46	16	18	80	21	24	114	0	5	148	8	14
13	13	14	47	17	19	81	22	25	115	1	6	149	9	15
14	14	15	48	18	20	82	23	26	116	2	7	150	10	16
15	15	16	49	19	21	83	24	27	117	3	8	151	11	17
16	16	17	50	20	22	84	25	28	118	4	9	152	12	18
17	17	18	51	21	23	85	26	29	119	5	10	153	13	19
18	18	19	52	22	24	86	27	30	120	6	11	154	14	20
19	19	20	53	23	25	87	0	4	121	7	12	155	15	21
20	20	21	54	24	26	88	1	5	122	8	13	156	16	22
21	21	22	55	25	27	89	2	6	123	9	14	157	17	23
22	22	23	56	26	28	90	3	7	124	10	15	158	18	24
23	23	24	57	27	29	91	4	8	125	11	16	159	19	25
24	24	25	58	28	30	92	5	9	126	12	17	160	20	26
25	25	26	59	0	3	93	6	10	127	13	18	161	21	27
26	26	27	60	1	4	94	7	11	128	14	19	162	22	28
27	27	28	61	2	5	95	8	12	129	15	20	163	23	29
28	28	29	62	3	6	96	9	13	130	16	21	164	24	30
29	29	30	63	4	7	97	10	14	131	17	22	165	0	7
30	0	2	64	5	8	98	11	15	132	18	23	166	1	8
31	1	3	65	6	9	99	12	16	133	19	24	167	2	9
32	2	4	66	7	10	100	13	17	134	20	25	-	-	-
33	3	5	67	8	11	101	14	18	135	21	26	-	-	-

### 6.11.2.2 Mapping to resource elements

The mapping of the sequence to resource elements depends on the frame structure. In a subframe for frame structure type 1 and in a half-frame for frame structure type 2, the same antenna port as for the primary synchronization signal shall be used for the secondary synchronization signal.

The sequence  $d(n)$  shall be mapped to resource elements according to

$$a_{k,l} = d(n), \quad n = 0, \dots, 61$$

$$k = n - 31 + \frac{N_{RB}^{DL} N_{sc}^{RB}}{2}$$

$$l = \begin{cases} N_{\text{symp}}^{DL} - 2 & \text{in slots 0 and 10} & \text{for frame structure type 1} \\ N_{\text{symp}}^{DL} - 1 & \text{in slots 1 and 11} & \text{for frame structure type 2} \end{cases}$$

Resource elements  $(k, l)$  where

$$k = n - 31 + \frac{N_{\text{RB}}^{\text{DL}} N_{\text{sc}}^{\text{RB}}}{2}$$

$$l = \begin{cases} N_{\text{ymb}}^{\text{DL}} - 2 & \text{in slots 0 and 10 for frame structure type 1} \\ N_{\text{ymb}}^{\text{DL}} - 1 & \text{in slots 1 and 11 for frame structure type 2} \end{cases}$$

$$n = -5, -4, \dots, -1, 62, 63, \dots, 66$$

are reserved and not used for transmission of the secondary synchronization signal.

## 6.12 OFDM baseband signal generation

The time-continuous signal  $s_l^{(p)}(t)$  on antenna port  $p$  in OFDM symbol  $l$  in a downlink slot is defined by

$$s_l^{(p)}(t) = \sum_{k=-\lfloor N_{\text{RB}}^{\text{DL}} N_{\text{sc}}^{\text{RB}} / 2 \rfloor}^{-1} a_{k^{(-)}, l}^{(p)} \cdot e^{j2\pi k \Delta f (t - N_{\text{CP}, l} T_s)} + \sum_{k=1}^{\lfloor N_{\text{RB}}^{\text{DL}} N_{\text{sc}}^{\text{RB}} / 2 \rfloor} a_{k^{(+)}, l}^{(p)} \cdot e^{j2\pi k \Delta f (t - N_{\text{CP}, l} T_s)}$$

for  $0 \leq t < (N_{\text{CP}, l} + N) \times T_s$  where  $k^{(-)} = k + \lfloor N_{\text{RB}}^{\text{DL}} N_{\text{sc}}^{\text{RB}} / 2 \rfloor$  and  $k^{(+)} = k + \lfloor N_{\text{RB}}^{\text{DL}} N_{\text{sc}}^{\text{RB}} / 2 \rfloor - 1$ . The variable  $N$  equals 2048 for  $\Delta f = 15$  kHz subcarrier spacing and 4096 for  $\Delta f = 7.5$  kHz subcarrier spacing.

The OFDM symbols in a slot shall be transmitted in increasing order of  $l$ , starting with  $l = 0$ , where OFDM symbol  $l > 0$  starts at time  $\sum_{l'=0}^{l-1} (N_{\text{CP}, l'} + N) T_s$  within the slot. In case the first OFDM symbol(s) in a slot use normal cyclic prefix and the remaining OFDM symbols use extended cyclic prefix, the starting position the OFDM symbols with extended cyclic prefix shall be identical to those in a slot where all OFDM symbols use extended cyclic prefix. Thus there will be a part of the time slot between the two cyclic prefix regions where the transmitted signal is not specified.

Table 6.12-1 lists the value of  $N_{\text{CP}, l}$  that shall be used. Note that different OFDM symbols within a slot in some cases have different cyclic prefix lengths.

**Table 6.12-1: OFDM parameters.**

Configuration		Cyclic prefix length $N_{\text{CP}, l}$
Normal cyclic prefix	$\Delta f = 15$ kHz	160 for $l = 0$
		144 for $l = 1, 2, \dots, 6$
Extended cyclic prefix	$\Delta f = 15$ kHz	512 for $l = 0, 1, \dots, 5$
	$\Delta f = 7.5$ kHz	1024 for $l = 0, 1, 2$

## 6.13 Modulation and upconversion

Modulation and upconversion to the carrier frequency of the complex-valued OFDM baseband signal for each antenna port is shown in Figure 6.13-1. The filtering required prior to transmission is defined by the requirements in [6].

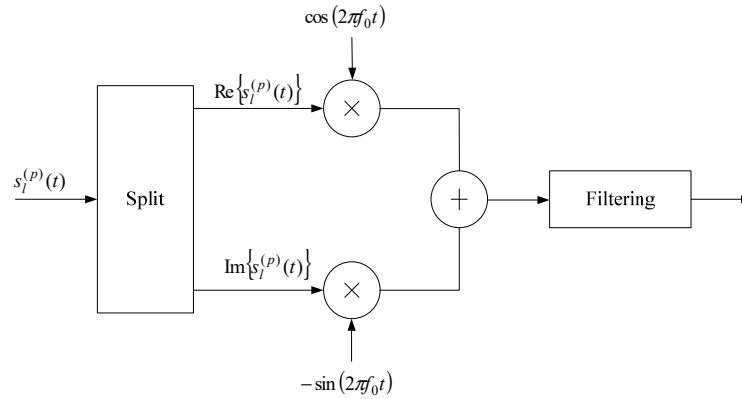

Figure 6.13-1: Downlink modulation.

## 7 Generic functions

### 7.1 Modulation mapper

The modulation mapper takes binary digits, 0 or 1, as input and produces complex-valued modulation symbols,  $x=I+jQ$ , as output.

#### 7.1.1 BPSK

In case of BPSK modulation, a single bit,  $b(i)$ , is mapped to a complex-valued modulation symbol  $x=I+jQ$  according to Table 7.1.1-1.

Table 7.1.1-1: BPSK modulation mapping

$b(i)$	$I$	$Q$
0	$1/\sqrt{2}$	$1/\sqrt{2}$
1	$-1/\sqrt{2}$	$-1/\sqrt{2}$

#### 7.1.2 QPSK

In case of QPSK modulation, pairs of bits,  $b(i), b(i+1)$ , are mapped to complex-valued modulation symbols  $x=I+jQ$  according to Table 7.1.2-1.

Table 7.1.2-1: QPSK modulation mapping

$b(i), b(i+1)$	$I$	$Q$
00	$1/\sqrt{2}$	$1/\sqrt{2}$
01	$1/\sqrt{2}$	$-1/\sqrt{2}$
10	$-1/\sqrt{2}$	$1/\sqrt{2}$
11	$-1/\sqrt{2}$	$-1/\sqrt{2}$

### 7.1.3 16QAM

In case of 16QAM modulation, quadruplets of bits,  $b(i), b(i+1), b(i+2), b(i+3)$ , are mapped to complex-valued modulation symbols  $x=I+jQ$  according to Table 7.1.3-1.

**Table 7.1.3-1: 16QAM modulation mapping**

$b(i), b(i+1), b(i+2), b(i+3)$	$I$	$Q$
0000	$1/\sqrt{10}$	$1/\sqrt{10}$
0001	$1/\sqrt{10}$	$3/\sqrt{10}$
0010	$3/\sqrt{10}$	$1/\sqrt{10}$
0011	$3/\sqrt{10}$	$3/\sqrt{10}$
0100	$1/\sqrt{10}$	$-1/\sqrt{10}$
0101	$1/\sqrt{10}$	$-3/\sqrt{10}$
0110	$3/\sqrt{10}$	$-1/\sqrt{10}$
0111	$3/\sqrt{10}$	$-3/\sqrt{10}$
1000	$-1/\sqrt{10}$	$1/\sqrt{10}$
1001	$-1/\sqrt{10}$	$3/\sqrt{10}$
1010	$-3/\sqrt{10}$	$1/\sqrt{10}$
1011	$-3/\sqrt{10}$	$3/\sqrt{10}$
1100	$-1/\sqrt{10}$	$-1/\sqrt{10}$
1101	$-1/\sqrt{10}$	$-3/\sqrt{10}$
1110	$-3/\sqrt{10}$	$-1/\sqrt{10}$
1111	$-3/\sqrt{10}$	$-3/\sqrt{10}$

### 7.1.4 64QAM

In case of 64QAM modulation, hexuplets of bits,  $b(i), b(i+1), b(i+2), b(i+3), b(i+4), b(i+5)$ , are mapped to complex-valued modulation symbols  $x=I+jQ$  according to Table 7.1.4-1.

Table 7.1.4-1: 64QAM modulation mapping

$b(i), b(i+1), b(i+2), b(i+3), b(i+4), b(i+5)$	$I$	$Q$	$b(i), b(i+1), b(i+2), b(i+3), b(i+4), b(i+5)$	$I$	$Q$
000000	$3/\sqrt{42}$	$3/\sqrt{42}$	100000	$-3/\sqrt{42}$	$3/\sqrt{42}$
000001	$3/\sqrt{42}$	$1/\sqrt{42}$	100001	$-3/\sqrt{42}$	$1/\sqrt{42}$
000010	$1/\sqrt{42}$	$3/\sqrt{42}$	100010	$-1/\sqrt{42}$	$3/\sqrt{42}$
000011	$1/\sqrt{42}$	$1/\sqrt{42}$	100011	$-1/\sqrt{42}$	$1/\sqrt{42}$
000100	$3/\sqrt{42}$	$5/\sqrt{42}$	100100	$-3/\sqrt{42}$	$5/\sqrt{42}$
000101	$3/\sqrt{42}$	$7/\sqrt{42}$	100101	$-3/\sqrt{42}$	$7/\sqrt{42}$
000110	$1/\sqrt{42}$	$5/\sqrt{42}$	100110	$-1/\sqrt{42}$	$5/\sqrt{42}$
000111	$1/\sqrt{42}$	$7/\sqrt{42}$	100111	$-1/\sqrt{42}$	$7/\sqrt{42}$
001000	$5/\sqrt{42}$	$3/\sqrt{42}$	101000	$-5/\sqrt{42}$	$3/\sqrt{42}$
001001	$5/\sqrt{42}$	$1/\sqrt{42}$	101001	$-5/\sqrt{42}$	$1/\sqrt{42}$
001010	$7/\sqrt{42}$	$3/\sqrt{42}$	101010	$-7/\sqrt{42}$	$3/\sqrt{42}$
001011	$7/\sqrt{42}$	$1/\sqrt{42}$	101011	$-7/\sqrt{42}$	$1/\sqrt{42}$
001100	$5/\sqrt{42}$	$5/\sqrt{42}$	101100	$-5/\sqrt{42}$	$5/\sqrt{42}$
001101	$5/\sqrt{42}$	$7/\sqrt{42}$	101101	$-5/\sqrt{42}$	$7/\sqrt{42}$
001110	$7/\sqrt{42}$	$5/\sqrt{42}$	101110	$-7/\sqrt{42}$	$5/\sqrt{42}$
001111	$7/\sqrt{42}$	$7/\sqrt{42}$	101111	$-7/\sqrt{42}$	$7/\sqrt{42}$
010000	$3/\sqrt{42}$	$-3/\sqrt{42}$	110000	$-3/\sqrt{42}$	$-3/\sqrt{42}$
010001	$3/\sqrt{42}$	$-1/\sqrt{42}$	110001	$-3/\sqrt{42}$	$-1/\sqrt{42}$
010010	$1/\sqrt{42}$	$-3/\sqrt{42}$	110010	$-1/\sqrt{42}$	$-3/\sqrt{42}$
010011	$1/\sqrt{42}$	$-1/\sqrt{42}$	110011	$-1/\sqrt{42}$	$-1/\sqrt{42}$
010100	$3/\sqrt{42}$	$-5/\sqrt{42}$	110100	$-3/\sqrt{42}$	$-5/\sqrt{42}$
010101	$3/\sqrt{42}$	$-7/\sqrt{42}$	110101	$-3/\sqrt{42}$	$-7/\sqrt{42}$
010110	$1/\sqrt{42}$	$-5/\sqrt{42}$	110110	$-1/\sqrt{42}$	$-5/\sqrt{42}$
010111	$1/\sqrt{42}$	$-7/\sqrt{42}$	110111	$-1/\sqrt{42}$	$-7/\sqrt{42}$
011000	$5/\sqrt{42}$	$-3/\sqrt{42}$	111000	$-5/\sqrt{42}$	$-3/\sqrt{42}$
011001	$5/\sqrt{42}$	$-1/\sqrt{42}$	111001	$-5/\sqrt{42}$	$-1/\sqrt{42}$
011010	$7/\sqrt{42}$	$-3/\sqrt{42}$	111010	$-7/\sqrt{42}$	$-3/\sqrt{42}$
011011	$7/\sqrt{42}$	$-1/\sqrt{42}$	111011	$-7/\sqrt{42}$	$-1/\sqrt{42}$
011100	$5/\sqrt{42}$	$-5/\sqrt{42}$	111100	$-5/\sqrt{42}$	$-5/\sqrt{42}$
011101	$5/\sqrt{42}$	$-7/\sqrt{42}$	111101	$-5/\sqrt{42}$	$-7/\sqrt{42}$
011110	$7/\sqrt{42}$	$-5/\sqrt{42}$	111110	$-7/\sqrt{42}$	$-5/\sqrt{42}$
011111	$7/\sqrt{42}$	$-7/\sqrt{42}$	111111	$-7/\sqrt{42}$	$-7/\sqrt{42}$

## 7.2 Pseudo-random sequence generation

Pseudo-random sequences are defined by a length-31 Gold sequence. The output sequence  $c(n)$  of length  $M_{\text{PN}}$ , where  $n = 0, 1, \dots, M_{\text{PN}} - 1$ , is defined by

$$\begin{aligned}
 c(n) &= (x_1(n + N_C) + x_2(n + N_C)) \bmod 2 \\
 x_1(n + 31) &= (x_1(n + 3) + x_1(n)) \bmod 2 \\
 x_2(n + 31) &= (x_2(n + 3) + x_2(n + 2) + x_2(n + 1) + x_2(n)) \bmod 2
 \end{aligned}$$

where  $N_C = 1600$  and the first m-sequence shall be initialized with  $x_1(0) = 1, x_1(n) = 0, n = 1, 2, \dots, 30$ . The initialization of the second m-sequence is denoted by  $c_{\text{init}} = \sum_{i=0}^{30} x_2(i) \cdot 2^i$  with the value depending on the application of the sequence.

## 8 Timing

### 8.1 Uplink-downlink frame timing

Transmission of the uplink radio frame number  $i$  from the UE shall start  $(N_{TA} + N_{TA \text{ offset}}) \times T_s$  seconds before the start of the corresponding downlink radio frame at the UE, where  $0 \leq N_{TA} \leq 20512$ ,  $N_{TA \text{ offset}} = 0$  for frame structure type 1 and  $N_{TA \text{ offset}} = 624$  for frame structure type 2. Note that not all slots in a radio frame may be transmitted. One example hereof is TDD, where only a subset of the slots in a radio frame is transmitted.

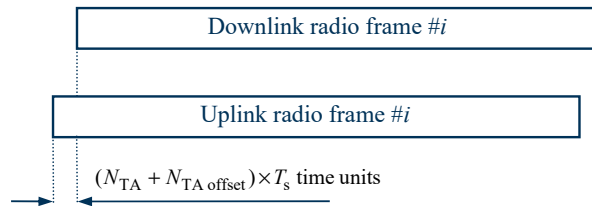

**Figure 8.1-1: Uplink-downlink timing relation**

## Annex A (informative): Change history

Change history							
Date	TSG #	TSG Doc.	CR	Rev	Subject/Comment	Old	New
2006-09-24	-	-	-	-	Draft version created	-	0.0.0
2006-10-09	-	-	-	-	Updated skeleton	0.0.0	0.0.1
2006-10-13	-	-	-	-	Endorsed by RAN1	0.0.1	0.1.0
2006-10-23	-	-	-	-	Inclusion of decision from RAN1#46bis	0.1.0	0.1.1
2006-11-06	-	-	-	-	Updated editor's version	0.1.1	0.1.2
2006-11-09	-	-	-	-	Updated editor's version	0.1.2	0.1.3
2006-11-10	-	-	-	-	Endorsed by RAN1#47	0.1.3	0.2.0
2006-11-27	-	-	-	-	Editor's version, including decisions from RAN1#47	0.2.0	0.2.1
2006-12-14	-	-	-	-	Updated editor's version	0.2.1	0.2.2
2007-01-15	-	-	-	-	Updated editor's version	0.2.2	0.2.3
2007-01-19	-	-	-	-	Endorsed by RAN1#47bis	0.2.3	0.3.0
2007-02-01	-	-	-	-	Editor's version, including decisions from RAN1#47bis	0.3.0	0.3.1
2007-02-12	-	-	-	-	Updated editor's version	0.3.1	0.3.2
2007-02-16	-	-	-	-	Endorsed by RAN1#48	0.3.2	0.4.0
2007-02-16	-	-	-	-	Editor's version, including decisions from RAN1#48	0.4.0	0.4.1
2007-02-21	-	-	-	-	Updated editor's version	0.4.1	0.4.2
2007-03-03	RAN#35	RP-070169			For information at RAN#35	0.4.2	1.0.0
2007-04-25	-	-	-	-	Editor's version, including decisions from RAN1#48bis and RAN1 TDD Ad Hoc	1.0.0	1.0.1
2007-05-03	-	-	-	-	Updated editor's version	1.0.1	1.0.2
2007-05-08	-	-	-	-	Updated editor's version	1.0.2	1.0.3
2007-05-11	-	-	-	-	Updated editor's version	1.0.3	1.0.4
2007-05-11	-	-	-	-	Endorsed by RAN1#49	1.0.4	1.1.0
2007-05-15	-	-	-	-	Editor's version, including decisions from RAN1#49	1.1.0	1.1.1
2007-06-05	-	-	-	-	Updated editor's version	1.1.1	1.1.2
2007-06-25	-	-	-	-	Endorsed by RAN1#49bis	1.1.2	1.2.0
2007-07-10	-	-	-	-	Editor's version, including decisions from RAN1#49bis	1.2.0	1.2.1
2007-08-10	-	-	-	-	Updated editor's version	1.2.1	1.2.2
2007-08-20	-	-	-	-	Updated editor's version	1.2.2	1.2.3
2007-08-24	-	-	-	-	Endorsed by RAN1#50	1.2.3	1.3.0
2007-08-27	-	-	-	-	Editor's version, including decisions from RAN1#50	1.3.0	1.3.1
2007-09-05	-	-	-	-	Updated editor's version	1.3.1	1.3.2
2007-09-08	RAN#37	RP-070729			For approval at RAN#37	1.3.2	2.0.0
12/09/07	RAN_37	RP-070729			Approved version	2.0.0	8.0.0
28/11/07	RAN_38	RP-070949	0001	-	Introduction of optimized FS2 for TDD	8.0.0	8.1.0
28/11/07	RAN_38	RP-070949	0002	-	Introduction of scrambling sequences, uplink reference signal sequences, secondary synchronization sequences and control channel processing	8.0.0	8.1.0
05/03/08	RAN_39	RP-080219	0003	1	Update of uplink reference-signal hopping, downlink reference signals, scrambling sequences, DwPTS/UpPTS lengths for TDD and control channel processing	8.1.0	8.2.0
28/05/08	RAN_40	RP-080432	0004	-	Correction of the number of subcarriers in PUSCH transform precoding	8.2.0	8.3.0
28/05/08	RAN_40	RP-080432	0005	-	Correction of PHICH mapping	8.2.0	8.3.0
28/05/08	RAN_40	RP-080432	0006	-	Correction of PUCCH resource index for PUCCH format 2	8.2.0	8.3.0
28/05/08	RAN_40	RP-080432	0007	3	Correction of the predefined hopping pattern for PUSCH	8.2.0	8.3.0
28/05/08	RAN_40	RP-080432	0008	-	Non-binary hashing functions	8.2.0	8.3.0
28/05/08	RAN_40	RP-080432	0009	1	PUCCH format 1	8.2.0	8.3.0
28/05/08	RAN_40	RP-080432	0010	1	CR on Uplink DM RS hopping	8.2.0	8.3.0
28/05/08	RAN_40	RP-080432	0012	1	Correction to limitation of constellation size of ACK transmission in PUSCH	8.2.0	8.3.0
28/05/08	RAN_40	RP-080432	0015	1	PHICH mapping for one and two antenna ports in extended CP	8.2.0	8.3.0
28/05/08	RAN_40	RP-080432	0016	1	Correction of PUCCH in absent of mixed format	8.2.0	8.3.0
28/05/08	RAN_40	RP-080432	0017	-	Specification of CCE size and PHICH resource indication	8.2.0	8.3.0
28/05/08	RAN_40	RP-080432	0018	3	Correction of the description of frame structure type 2	8.2.0	8.3.0
28/05/08	RAN_40	RP-080432	0019	-	On Delta <sup>pucch</sup> shift correction	8.2.0	8.3.0
28/05/08	RAN_40	RP-080432	0021	-	Corrections to Secondary Synchronization Signal Mapping	8.2.0	8.3.0
28/05/08	RAN_40	RP-080432	0022	-	Downlink VRB mapping to PRB for distributed transmission	8.2.0	8.3.0
28/05/08	RAN_40	RP-080432	0023	-	Clarification of modulation symbols to REs mapping for DVRB	8.2.0	8.3.0
28/05/08	RAN_40	RP-080432	0024	1	Consideration on the scrambling of PDSCH	8.2.0	8.3.0
28/05/08	RAN_40	RP-080432	0025	-	Corrections to Initialization of DL RS Scrambling	8.2.0	8.3.0
28/05/08	RAN_40	RP-080432	0026	1	CR on Downlink RS	8.2.0	8.3.0
28/05/08	RAN_40	RP-080432	0027	-	CR on Uplink RS	8.2.0	8.3.0

Change history							
Date	TSG #	TSG Doc.	CR	Rev	Subject/Comment	Old	New
28/05/08	RAN_40	RP-080432	0028	1	Fixed timing advance offset for LTE TDD and half-duplex FDD	8.2.0	8.3.0
28/05/08	RAN_40	RP-080432	0029	1	Timing of random access preamble format 4	8.2.0	8.3.0
28/05/08	RAN_40	RP-080432	0030	1	Uplink sounding RS bandwidth configuration	8.2.0	8.3.0
28/05/08	RAN_40	RP-080432	0031	-	Use of common RS when UE-specific RS are configured	8.2.0	8.3.0
28/05/08	RAN_40	RP-080432	0032	1	Uplink RS Updates	8.2.0	8.3.0
28/05/08	RAN_40	RP-080432	0033	-	Orthogonal cover sequence for shortened PUCCH format 1a and 1b	8.2.0	8.3.0
28/05/08	RAN_40	RP-080432	0034	-	Clarification of PDCCH mapping	8.2.0	8.3.0
28/05/08	RAN_40	RP-080432	0035	-	TDD PRACH time/frequency mapping	8.2.0	8.3.0
28/05/08	RAN_40	RP-080432	0036	-	Cell Specific Uplink Sounding RS Subframe Configuration	8.2.0	8.3.0
28/05/08	RAN_40	RP-080432	0038	-	PDCCH length for carriers with mixed MBSFN and Unicast Traffic	8.2.0	8.3.0
28/05/08	RAN_40	RP-080432	0040	-	Correction to the scrambling sequence generation for PUCCH, PCFICH, PHICH, MBSFN RS and UE specific RS	8.2.0	8.3.0
28/05/08	RAN_40	RP-080432	0041	-	PDCCH coverage in narrow bandwidths	8.2.0	8.3.0
28/05/08	RAN_40	RP-080432	0042	-	Closed-Loop and Open-Loop Spatial Multiplexing	8.2.0	8.3.0
28/05/08	RAN_40	RP-080432	0043	-	Removal of small-delay CDD	8.2.0	8.3.0
09/09/08	RAN_41	RP-080668	48	1	Frequency Shifting of UE-specific RS	8.3.0	8.4.0
09/09/08	RAN_41	RP-080668	49	1	Correction of PHICH to RE mapping in extended CP subframe	8.3.0	8.4.0
09/09/08	RAN_41	RP-080668	50	-	Corrections to for handling remaining Res	8.3.0	8.4.0
09/09/08	RAN_41	RP-080668	51	-	PRACH configuration for frame structure type 1	8.3.0	8.4.0
09/09/08	RAN_41	RP-080668	52	2	Correction of PUCCH index generation formula	8.3.0	8.4.0
09/09/08	RAN_41	RP-080668	53	-	Orthogonal cover sequence for shortened PUCCH format 1a and 1b	8.3.0	8.4.0
09/09/08	RAN_41	RP-080668	54	-	Correction of mapping of ACK/NAK to binary bit values	8.3.0	8.4.0
09/09/08	RAN_41	RP-080668	56	2	Remaining issues on SRS hopping	8.3.0	8.4.0
09/09/08	RAN_41	RP-080668	57	1	Correction of n <sub>cs</sub> (n <sub>s</sub> ) and OC/CS remapping for PUCCH formats 1/1a/1b and 2/2a/2b	8.3.0	8.4.0
09/09/08	RAN_41	RP-080668	59	-	Corrections to Rank information scrambling in Uplink Shared Channel	8.3.0	8.4.0
09/09/08	RAN_41	RP-080668	60	-	Definition on the slot number for frame structure type 2	8.3.0	8.4.0
09/09/08	RAN_41	RP-080668	61	-	Correction of the Npucch sequence upper limit for the formats 1/1a/1b	8.3.0	8.4.0
09/09/08	RAN_41	RP-080668	62	1	Clarifications for DMRS parameters	8.3.0	8.4.0
09/09/08	RAN_41	RP-080668	63	-	Correction of n <sub>prs</sub>	8.3.0	8.4.0
09/09/08	RAN_41	RP-080668	64	1	Introducing missing L1 parameters to 36.211	8.3.0	8.4.0
09/09/08	RAN_41	RP-080668	65	3	Clarification on reception of synchronization signals	8.3.0	8.4.0
09/09/08	RAN_41	RP-080668	66	-	Correction to the downlink/uplink timing	8.3.0	8.4.0
09/09/08	RAN_41	RP-080668	67	-	ACK/NAK Scrambling scheme on PUCCH	8.3.0	8.4.0
09/09/08	RAN_41	RP-080668	68	-	DCI format1C	8.3.0	8.4.0
09/09/08	RAN_41	RP-080668	69	-	Refinement for REG Definition for n = 4	8.3.0	8.4.0
09/09/08	RAN_41	RP-080668	71	-	Correcting Ncs value for PRACH preamble format 0-3	8.3.0	8.4.0
09/09/08	RAN_41	RP-080668	73	-	Correction of the half duplex timing advance offset value	8.3.0	8.4.0
09/09/08	RAN_41	RP-080668	74	-	Correction to Precoding for Transmit Diversity	8.3.0	8.4.0
09/09/08	RAN_41	RP-080668	75	-	Clarification on number of OFDM symbols used for PDCCH	8.3.0	8.4.0
09/09/08	RAN_41	RP-080668	77	-	Number of antenna ports for PDSCH	8.3.0	8.4.0
09/09/08	RAN_41	RP-080668	78	-	Correction to Type 2 PUSCH predetermined hopping for Nsb=1 operation	8.3.0	8.4.0
09/09/08	RAN_41	RP-080668	79	-	PRACH frequency location	8.3.0	8.4.0
03/12/08	RAN_42	RP-081074	70	1	Correction for the definition of UE-specific reference signals	8.4.0	8.5.0
03/12/08	RAN_42	RP-081074	72	2	Corrections to precoding for large delay CDD	8.4.0	8.5.0
03/12/08	RAN_42	RP-081074	80	-	Correction to the definition of nbar <sub>oc</sub> for extended CP	8.4.0	8.5.0
03/12/08	RAN_42	RP-081074	81	1	Specification of reserved REs not used for RS	8.4.0	8.5.0
03/12/08	RAN_42	RP-081074	82	2	Clarification of the random access preamble transmission timing	8.4.0	8.5.0
03/12/08	RAN_42	RP-081074	83	1	Indexing of PRACH resources within the radio frame	8.4.0	8.5.0
03/12/08	RAN_42	RP-081074	84	6	Alignment of RAN1/RAN2 specification	8.4.0	8.5.0
03/12/08	RAN_42	RP-081074	86	-	Clarification on scrambling of ACK/NAK bits for PUCCH format 2a/2b	8.4.0	8.5.0
03/12/08	RAN_42	RP-081074	87	-	Correction of introduction of shortened SR	8.4.0	8.5.0
03/12/08	RAN_42	RP-081074	88	-	Corrections to 36.211	8.4.0	8.5.0
03/12/08	RAN_42	RP-081074	89	-	Clarification on PUSCH DM RS Cyclic Shift Hopping	8.4.0	8.5.0
03/12/08	RAN_42	RP-081074	92	1	Correction to the uplink DM RS assignment	8.4.0	8.5.0
03/12/08	RAN_42	RP-081074	93	-	Clarify the RNTI used in scrambling sequence initialization	8.4.0	8.5.0
03/12/08	RAN_42	RP-081074	94	1	On linkage Among UL Power Control Parameters	8.4.0	8.5.0
03/12/08	RAN_42	RP-081074	95	-	Clarification on PUSCH pre-determined hopping pattern	8.4.0	8.5.0
03/12/08	RAN_42	RP-081074	96	-	Clarification of SRS sequence-group and base sequence number	8.4.0	8.5.0
03/12/08	RAN_42	RP-081074	97	1	SRS subframe configuration	8.4.0	8.5.0
03/12/08	RAN_42	RP-081074	98	-	Remaining SRS details for TDD	8.4.0	8.5.0
03/12/08	RAN_42	RP-081074	99	-	Clarifying UL VRB Allocation	8.4.0	8.5.0
03/12/08	RAN_42	RP-081074	100	-	Clarification on PUCCH resource hopping	8.4.0	8.5.0
03/12/08	RAN_42	RP-081074	101	-	Correction for definition of Q <sub>m</sub> and a pseudo code syntax error in Scrambling.	8.4.0	8.5.0
03/12/08	RAN_42	RP-081074	105	1	Remaining Issues on SRS of TDD	8.4.0	8.5.0
03/12/08	RAN_42	RP-081074	106	-	Correction of reference to RAN4 specification of supported uplink	8.4.0	8.5.0

Change history							
Date	TSG #	TSG Doc.	CR	Rev	Subject/Comment	Old	New
					bandwidth		
03/12/08	RAN_42	RP-081074	107	-	General corrections to SRS	8.4.0	8.5.0
03/12/08	RAN_42	RP-081074	109	2	Correction to PCFICH specification	8.4.0	8.5.0
03/12/08	RAN_42	RP-081074	110	1	Correction to Layer Mapping for Transmit Diversity with Four Antenna Ports	8.4.0	8.5.0
03/12/08	RAN_42	RP-081074	111	-	Correction of the mapping of cyclic shift filed in DCI format 0 to the dynamic cyclic shift offset	8.4.0	8.5.0
03/12/08	RAN_42	RP-081074	112	-	DRS collision handling	8.4.0	8.5.0
03/12/08	RAN_42	RP-081074	113	-	Clarification to enable reuse of non-active PUCCH CQI RBs for PUSCH	8.4.0	8.5.0
03/12/08	RAN_42	RP-081074	114	1	PUSCH Mirror Hopping operation	8.4.0	8.5.0
03/12/08	RAN_42	RP-081074	108	1	Extended and normal cyclic prefix in DL and UL for LTE TDD	8.4.0	8.5.0
04/03/09	RAN_43	RP-090234	115	1	Alignment of PRACH configuration index for FS type 1 and type 2	8.5.0	8.6.0
04/03/09	RAN_43	RP-090234	118	1	Clarification for DRS Collision handling	8.5.0	8.6.0
04/03/09	RAN_43	RP-090234	121	1	Removing inverse modulo operation	8.5.0	8.6.0
04/03/09	RAN_43	RP-090234	123	1	Clarification on the use of preamble format 4	8.5.0	8.6.0
04/03/09	RAN_43	RP-090234	124	-	Clarification of RNTI used in scrambling sequence	8.5.0	8.6.0
04/03/09	RAN_43	RP-090234	125	1	Clarifying PDCCH RE mapping	8.5.0	8.6.0
04/03/09	RAN_43	RP-090234	126	-	Correction of preamble format 4 timing	8.5.0	8.6.0
04/03/09	RAN_43	RP-090234	127	2	Corrections to SRS	8.5.0	8.6.0
04/03/09	RAN_43	RP-090234	128	2	Clarification of PDSCH Mapping to Resource Elements	8.5.0	8.6.0
04/03/09	RAN_43	RP-090234	129	1	Alignment with correct ASN1 parameter names	8.5.0	8.6.0
04/03/09	RAN_43	RP-090234	130	-	Correction to PUCCH format 1 mapping to physical resources	8.5.0	8.6.0
04/03/09	RAN_43	RP-090234	132	-	Correction to type-2 PUSCH hopping	8.5.0	8.6.0
04/03/09	RAN_43	RP-090234	134	-	Alignment of SRS configuration	8.5.0	8.6.0
27/05/09	RAN_44	RP-090527	135	-	Correction on UE behavior for PRACH 20ms periodicity	8.6.0	8.7.0